



# OWNER'S MANUAL

Operation  
Maintenance  
Specifications

All information in this Owner's Manual is current at the time of publication. However, HYUNDAI reserves the right to make changes at any time so that our policy of continual product improvement may be carried out.

This manual applies to all HYUNDAI models and includes descriptions and explanations of optional as well as standard equipment. As a result, you may find material in this manual that does not apply to your specific vehicle.

### CAUTION: MODIFICATIONS TO YOUR HYUNDAI

Your HYUNDAI should not be modified in any way. Such modifications may adversely affect the performance, safety or durability of your HYUNDAI and may, in addition, violate conditions of the limited warranties covering the vehicle. Certain modifications may also be in violation of regulations established by the U.S. Department of Transportation and other federal or state agencies.

### TWO-WAY RADIO OR CELLULAR TELEPHONE INSTALLATION

Your vehicle is equipped with electronic fuel injection and other electronic components. It is possible for an improperly installed/adjusted two-way radio or cellular telephone to adversely affect electronic systems. For this reason, we recommend that you carefully follow the radio manufacturer's instructions or consult your HYUNDAI dealer for precautionary measures or special instructions if you choose to install one of these devices.

### SAFETY AND VEHICLE DAMAGE WARNING

This manual includes information titled as DANGER, WARNING, CAUTION and NOTICE.

These titles indicate the following:



#### **DANGER**

**DANGER** indicates a hazardous situation which, if not avoided, will result in death or serious injury.



#### **WARNING**

**WARNING** indicates a hazardous situation which, if not avoided, could result in death or serious injury.



#### **CAUTION**

**CAUTION** indicates a hazardous situation which, if not avoided, could result in minor or moderate injury.

#### **NOTICE**

**NOTICE** indicates a situation which, if not avoided, could result in vehicle damage.

---

## HYUNDAI VEHICLE OWNER PRIVACY POLICY

Your Hyundai vehicle may be equipped with technologies and services that use information collected, generated, recorded or stored by the vehicle. Hyundai has created a Vehicle Owner Privacy Policy to explain how these technologies and services collect use and share this information.

You may read our Vehicle Owner Privacy Policy on the Hyundaiusa.com website at: <https://www.hyundaiusa.com/owner-privacy-policy.aspx>

If you would like to receive a hard copy of our Vehicle Owner Privacy Policy, please contact our Customer Care Center at:

Hyundai Customer Care  
P.O. Box 20850  
Fountain Valley, CA 92728  
800-633-5151  
[consumeraffairs@hmausa.com](mailto:consumeraffairs@hmausa.com)

Hyundai's Customer Care Center representatives are available Monday through Friday,

between the hours of 6:00 AM and 5:00 PM PST and Saturday between 6:30 AM and 3:00 PM PST (English).

For Customer Care assistance in Spanish or Korean, representatives are available Monday through Friday between 6:30 AM and 3:00 PM PST.



## Table of Contents

---

Foreword	1
Vehicle Information	2
Seats & Safety System	3
Instrument Cluster	4
Convenient Features	5
Driving your vehicle	6
Driver assistance system	7
Emergency situations	8
Maintenance	9
Index	I

# 1. Foreword

---

Introduction.....	1-2
Hyundai Motor America .....	1-2
Guide to Hyundai Genuine Parts .....	1-3
How to Use This Manual.....	1-4
Safety Messages .....	1-4
Fuel Requirements.....	1-5
Gasoline containing alcohol or methanol .....	1-6
Using Fuel Additives (except Detergent Fuel Additives) .....	1-6
Gasoline containing MMT .....	1-6
Detergent Fuel Additives.....	1-7
Operation in foreign countries.....	1-7
Vehicle Modifications .....	1-7
Vehicle Break-In Process .....	1-7
Vehicle Data Collection and Event Data Recorders .....	1-8

## INTRODUCTION

Congratulations, and thank you for choosing HYUNDAI. We are pleased to welcome you to the growing number of discerning people who drive HYUNDAs. We are very proud of the advanced engineering and high-quality construction of each HYUNDAI we build.

Your Owner's Manual will introduce you to the features and operation of your new HYUNDAI. To become familiar with your new HYUNDAI, so that you can fully enjoy it, read this Owner's Manual carefully before driving your new vehicle.

This manual contains important safety information and instructions intended to familiarize you with your vehicle's controls and safety features so you can safely operate your vehicle.

This manual also contains information on maintenance designed to enhance safe operation of the vehicle. It is recommended that all service and maintenance on your car be performed by an authorized HYUNDAI dealer. HYUNDAI dealers are prepared to provide high-quality service, maintenance and any other assistance that may be required.

This Owner's Manual should be considered a permanent part of your vehicle, and should be kept in the vehicle so you can refer to it at any time. The manual should stay with the vehicle if you sell it to provide the next owner with important operating, safety and maintenance information.

## HYUNDAI MOTOR AMERICA



### CAUTION

**Severe engine and transmission damage may result from the use of poor quality fuels and lubricants that do not meet HYUNDAI specifications. You must always use high quality fuels and lubricants that meet the specifications listed on Page 2-13 in the Vehicle Specifications section of the Owner's Manual.**

Copyright 2020 HYUNDAI Motor America. All rights reserved. No part of this publication may be reproduced, stored in any retrieval system or transmitted in any form or by any means without the prior written permission of HYUNDAI Motor America.

## GUIDE TO HYUNDAI GENUINE PARTS

### 1. What are HYUNDAI Genuine Parts?

HYUNDAI Genuine Parts are the same parts used by HYUNDAI Motor Company to manufacture vehicles. They are designed and tested for the optimum safety, performance, and reliability for our customers.



### 2. Why Hyundai Genuine Parts?

HYUNDAI Genuine Parts are engineered and built to meet rigid manufacturing requirements. Damage caused by using imitation, counterfeit or used salvage parts is not covered under the HYUNDAI New Vehicle Limited Warranty or any other HYUNDAI warranty.

In addition, any damage to or failure of HYUNDAI Genuine Parts caused by the installation or failure of an imitation, counterfeit or used salvage part is not covered by any HYUNDAI Warranty.



### 3. How can you tell if you are purchasing HYUNDAI Genuine Parts?

Look for the HYUNDAI Genuine Parts Logo on the package (see below).

HYUNDAI Genuine Parts exported to the U.S. are packaged with labels written in English.

HYUNDAI Genuine Parts are only sold through authorized HYUNDAI Dealerships.

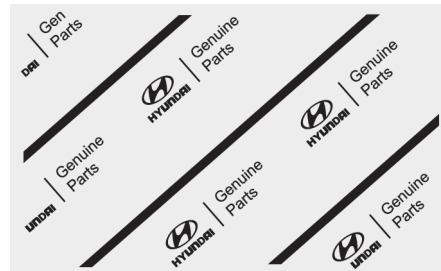



## HOW TO USE THIS MANUAL

We want to help you get the greatest possible driving pleasure from your vehicle. Your Owner's Manual can assist you in many ways. To gain an overview of the contents of your Owner's Manual, use the Table of Contents in the front of the manual. The first page of each Chapter includes a detailed Table of Contents of the topics in that Chapter.

To quickly locate information about your vehicle, use the Index in the back of the manual. It is an alphabetical list of what is in this manual and the page number where it can be found.

For your convenience, we have incorporated tabs on the right-hand page edges. These tabs are coded with the Chapter titles to assist you with navigating through the manual.

## SAFETY MESSAGES

Your safety, and the safety of others, is very important. This Owner's Manual provides you with many safety precautions and operating procedures. This information alerts you to potential hazards that may hurt you or others, as well as cause damage to your vehicle.

Safety messages found on vehicle labels and in this manual describe these hazards and what to do to avoid or reduce the risks.

Warnings and instructions contained in this manual are for your safety. Failure to follow safety warnings and instructions can lead to serious injury or death.

Throughout this manual DANGER, WARNING, CAUTION, NOTICE and the SAFETY ALERT SYMBOL will be used.



This is the safety alert symbol. It is used to alert you to potential physical injury hazards. Obey all safety messages that follow this symbol to avoid possible injury or death. The safety alert symbol precedes the signal words DANGER, WARNING and CAUTION.



### **DANGER**

**DANGER** indicates a hazardous situation which, if not avoided, will result in death or serious injury.



### **WARNING**

**WARNING** indicates a hazardous situation which, if not avoided, could result in death or serious injury.



### **CAUTION**

**CAUTION** indicates a hazardous situation which, if not avoided, could result in minor or moderate injury.

### **NOTICE**

**NOTICE** indicates a situation which, if not avoided, could result in vehicle damage.

## **FUEL REQUIREMENTS**

Your new vehicle is designed to obtain maximum performance with UNLEADED FUEL, as well as minimize exhaust emissions and spark plug fouling.

Your new vehicle is designed to use only unleaded fuel having an octane number  $((R+M)/2)$  of 87 (Research Octane Number 91) or higher. (Do not use methanol blended fuels)

### **NOTICE**

To prevent damage to the engine and engine components, never add any fuel system cleaning agents to the fuel tank other than what has been specified.

Consult an authorized HYUNDAI dealer for additional information.



### **WARNING**

- Do not “top off” after the nozzle automatically shuts off when refueling.
- Always check that the fuel cap is installed securely to prevent fuel spillage in the event of an accident.

### **Gasoline containing alcohol or methanol**

Gasohol, a mixture of gasoline and ethanol (also known as grain alcohol) are being marketed along with or instead of leaded or unleaded gasoline. For example, "E15" is a gasohol comprised of 15% ethanol and 85% gasoline.

Do not use gasohol containing more than 15% ethanol, and do not use gasoline or gasohol containing any methanol. Either of these fuels may cause drivability problems and damage to the fuel system, engine control system and emission control system.

Discontinue using gasohol of any kind if drivability problems occur.

"E85" fuel is an alternative fuel comprised of 85 percent ethanol and 15 percent gasoline, and is manufactured exclusively for use in Flexible Fuel Vehicles. "E85" is not compatible with your vehicle. Use of "E85" may result in poor engine performance and damage to your vehicle's engine and fuel system. HYUNDAI recommends that customers do not use fuel with an ethanol content exceeding 15 percent.

#### **NOTICE**

**To prevent damage to your vehicle's engine and fuel system:**

- **Never use gasohol which contains methanol.**
- **Never use gasohol containing more than 15% ethanol.**
- **Never use leaded fuel or leaded gasohol.**
- **Never use "E85" fuel.**

**Your New Vehicle Limited Warranty does not cover damage to the fuel system or any performance problems caused by the use of "E85" fuel.**

### **Using Fuel Additives (except Detergent Fuel Additives)**

Using fuel additives such as:

- Silicone fuel additive
  - Ferrocene (iron-based) fuel additive
  - Other metallic-based fuel additives
- may result in cylinder misfire, poor acceleration, engine stalling, damage to the catalyst, or abnormal corrosion, and may cause damage to the engine resulting in a reduction in the overall life of the powertrain.
- The Malfunction Indicator Lamp (MIL) may illuminate.

#### **NOTICE**

**Damage to the fuel system or performance problem caused by the use of these fuels or fuel additives may not be covered by your New Vehicle Limited Warranty.**

### **Gasoline containing MMT**

Some gasoline contains harmful manganese-based fuel additives such as MMT (Methylcyclopentadienyl Manganese Tricarbonyl).

HYUNDAI does not recommend the use of gasoline containing MMT.

This type of fuel can reduce vehicle performance and affect your emission control system.

The malfunction indicator lamp on the cluster may come on.

### **Detergent Fuel Additives**

HYUNDAI recommends that you use good quality gasolines treated with detergent additives such as TOP TIER Detergent Gasoline, which help prevent deposit formation in the engine. These gasolines will help the engine run cleaner and enhance performance of the Emission Control System. For more information on TOP TIER Detergent Gasoline, please go to the website ([www.toptiergas.com](http://www.toptiergas.com)).

For customers who do not use TOP Tier Detergent Gasoline regularly, and have problems starting or the engine does not run smoothly, detergent-based fuel additives that you can purchase separately may be added to the gasoline. If TOP TIER Detergent Gasoline is not available, one bottle of additive added to the fuel tank according to the maintenance schedule is recommended (refer to the Maintenance Schedule in chapter 8).

Additives are available from your authorized HYUNDAI dealer along with information on how to use them. Do not mix other additives.

### **Operation in foreign countries**

If you are going to drive your vehicle in another country, be sure to:

- Observe all regulations regarding registration and insurance.
- Determine that acceptable fuel is available.

## **VEHICLE MODIFICATIONS**

- This vehicle should not be modified. Modification of your vehicle could affect its performance, safety or durability and may even violate governmental safety and emissions regulations.  
In addition, damage or performance problems resulting from any modification may not be covered under warranty.
- If you use unauthorized electronic devices, it may cause the vehicle to operate abnormally, wire damage, battery discharge and fire. For your safety, do not use unauthorized electronic devices.

## **VEHICLE BREAK-IN PROCESS**

By following a few simple precautions for the first 600 miles (1,000 km) you may add to the performance, economy and life of your vehicle.

- Do not race the engine.
- While driving, keep your engine speed (rpm, or revolutions per minute) between 2,000 rpm and 4,000 rpm.
- Do not maintain a single speed for long periods of time, either fast or slow. Varying engine speed is needed to properly break-in the engine.
- Avoid hard stops, except in emergencies, to allow the brakes to seat properly.



## WARNING

### CALIFORNIA PROPOSITION 65 WARNING

Items contained in motor vehicles or emitted from them are known to the State of California to cause cancer and birth defects or reproductive harm. These include:

- Gasoline and its vapors
- Engine exhaust
- Used engine oil
- Interior passenger compartment components and materials
- Component parts which are subject to heat and wear

In addition, battery posts, terminals and related accessories contain lead, lead compounds and other chemicals known to the State of California to cause cancer and reproductive harm.

For more information go to <https://www.p65warnings.ca.gov/passenger-vehicle>

## VEHICLE DATA COLLECTION AND EVENT DATA RECORDERS

This vehicle is equipped with an event data recorder (EDR). The main purpose of an EDR is to record, in certain crash or near crash-like situations, such as an air bag deployment or hitting a road obstacle, data that will assist in understanding how a vehicle's systems performed. The EDR is designed to record data related to vehicle dynamics and safety systems for a short period of time, typically 30 seconds or less. The EDR in this vehicle is designed to record such data as:

- How various systems in your vehicle were operating;
- Whether or not the driver and passenger safety belts were buckled/ fastened;
- How far (if at all) the driver was depressing the accelerator and/or brake pedal; and,
- How fast the vehicle was traveling.

These data can help provide a better understanding of the circumstances in which crashes and injuries occur. **NOTE:** EDR data is recorded by your vehicle only if a non-trivial crash situation occurs; no data are recorded by the EDR under normal driving conditions and no personal data (e.g., name, gender, age, and crash location) are recorded. However, other parties, such as law enforcement, could combine the EDR data with the type of personally identifying data routinely acquired during a crash investigation.

To read data recorded by an EDR, special equipment is required, and access to the vehicle or the EDR is needed. In addition to the vehicle manufacturer, other parties, such as law enforcement, that have the special equipment, can read the information if they have access to the vehicle or the EDR.

## 2. Vehicle Information

---

Exterior Overview .....	2-2
Interior Overview .....	2-6
Instrument Panel Overview .....	2-7
Engine Compartment .....	2-8
Dimensions.....	2-9
Engine specification .....	2-9
Bulb Wattage.....	2-10
Tires and Wheels.....	2-11
Volume and Weight .....	2-12
Air Conditioning System.....	2-12
Recommended Lubricants and Capacities.....	2-13
Recommended SAE Viscosity Number .....	2-14
Vehicle Identification Number (VIN) .....	2-15
Vehicle Certification Label .....	2-15
Tire Specification and Pressure Label .....	2-16
Engine Number .....	2-16
Consumer Information .....	2-17
Reporting Safety Defects .....	2-18

## EXTERIOR OVERVIEW

■ Front view



The actual shape may differ from the illustration.

OCN7010001

1. Hood .....	5-59	5. Sunroof .....	5-55
2. Headlamp.....	9-53	6. Front windshield wiper blades .....	9-25
3. Tires and wheels .....	9-30	7. Windows .....	5-51
4. Side view mirror.....	5-49	8. Front radar .....	7-14

■ Front view (N Line)



- |                          |      |  |      |
|--------------------------|------|--|------|
| 1. Hood.....             | 5-59 | 6. Front windshield wiper blades ..... | 9-25 |
| 2. Headlamp.....         | 9-53 | 7. Windows .....                       | 5-51 |
| 3. Tires and wheels..... | 9-30 | 8. Front radar .....                   | 7-14 |
| 4. Side view mirror..... | 5-49 |  |      |
| 5. Sunroof.....          | 5-55 |  |      |



■ Rear view



9. Door.....	5-31	13. Defroster / Glass antenna .....	5-108/5-118
10. Fuel filler door.....	5-66	14. High mounted stop lamp .....	9-60
11. Rear combination lamp.....	9-57	15. Antenna .....	5-118
12. Trunk.....	5-61	16. Rear view camera .....	7-113

■ Rear view (N Line)



OCN7N010002N

9. Door.....	5-31	13. Defroster / Glass antenna .....	5-108/5-118
10. Fuel filler door.....	5-66	14. High mounted stop lamp .....	9-60
11. Rear combination lamp.....	9-57	15. Antenna.....	5-118
12. Trunk.....	5-61	16. Rear view camera.....	7-113

## INTERIOR OVERVIEW

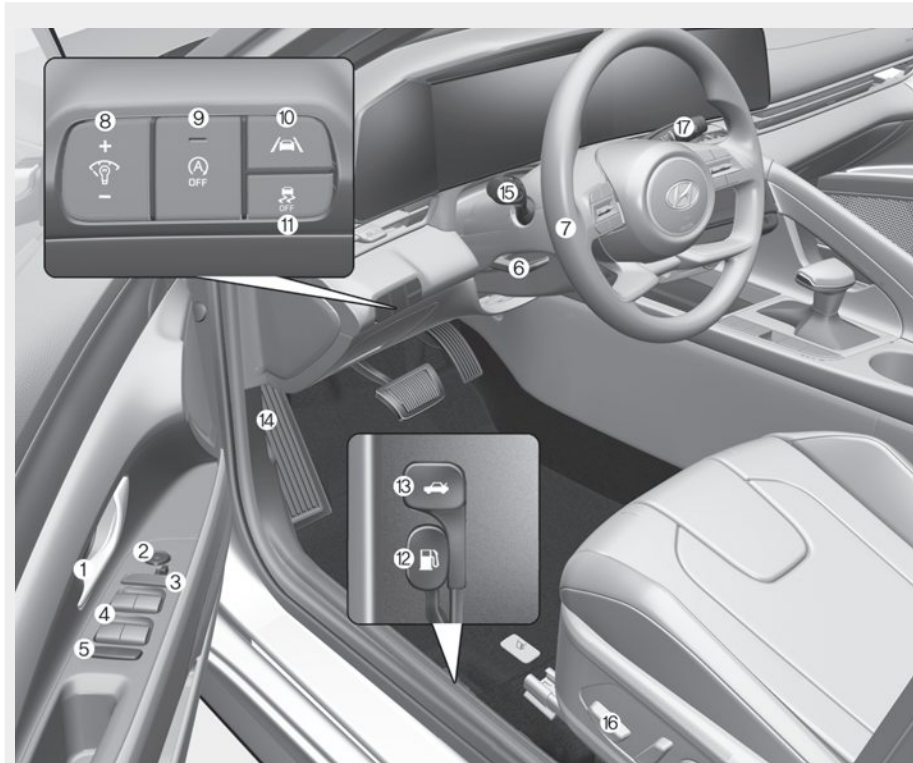

The actual shape may differ from the illustration.

OCN7010003N

- |  |      |   |      |
|--|------|---|------|
| 1. Inside door handle.....                               | 5-33 | 9. ISG (Idle Stop & Go) OFF button..... | 6-50 |
| 2. Side view mirror control switch.....                  | 5-50 | 10. Lane Safety button .....            | 7-31 |
| 3. Central door lock switch .....                        | 5-33 | 11. ESC OFF button .....                | 6-46 |
| 4. Power window switches .....                           | 5-51 | 12. Fuel filler door release lever..... | 5-66 |
| 5. Power window lock button.....                         | 5-54 | 13. Trunk release lever.....            | 5-61 |
| 6. Steering wheel tilt/telescopic lever ....             | 5-39 | 14. Hood release lever.....             | 5-59 |
| 7. Steering wheel.....                                   | 5-38 | 15. Light control/Turn signals.....     | 5-68 |
| 8. Instrument panel illumination control<br>switch ..... | 4-5  | 16. Seat adjusting switch.....          | 3-3  |
|  |      | 17. Wiper/washer switch .....           | 5-79 |

## INSTRUMENT PANEL OVERVIEW



- |  |           |   |                |
|--|-----------|---|----------------|
| 1. Instrument cluster .....            | 4-4       | 9. Glove box .....  | 5-110          |
| 2. Driver's front air bag.....         | 3-37      | 10. Manual transmission/<br>Intelligent variable transmission /<br>Dual clutch transmission ..... | 6-13/6-16/6-23 |
| 3. Engine start button.....            | 6-8       | 11. Drive mode button .....   | 6-54           |
| 4. Key ignition switch .....           | 6-5       | 12. Parking/View button .....   | 7-114          |
| 5. Infotainment system .....           | 5-117     | 13. Electronic parking brake switch.....  | 6-37           |
| 6. Hazard warning flasher switch ..... | 8-2       | 14. AUTO HOLD button.....   | 6-41           |
| 7. Climate control system .....        | 5-81/5-92 |   |                |
| 8. Passenger's front air bag .....     | 3-37      |   |                |

## ENGINE COMPARTMENT

■ Smartstream G 2.0 Atkinson

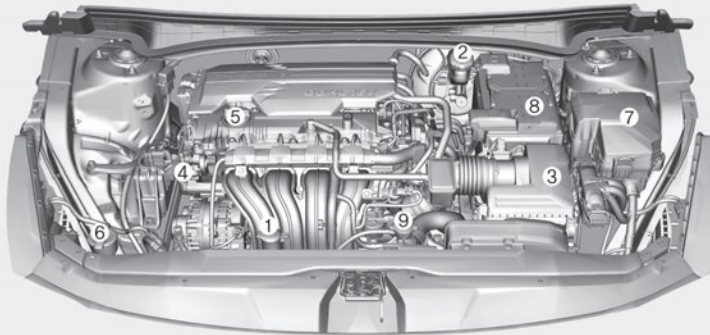

■ Smartstream G1.6 T-GDi

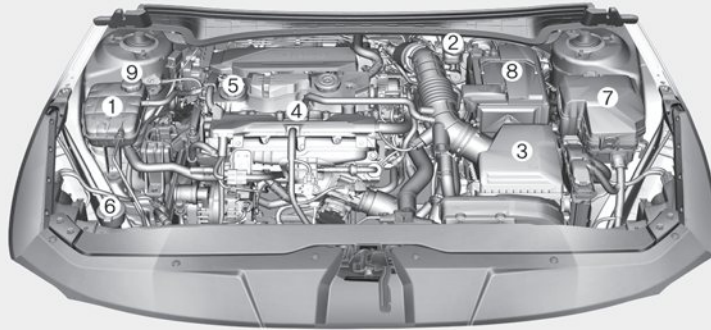

**The actual engine room in the vehicle may differ from the illustration.**

OCN7080064L/OCN7N080001

- |                                |      |  |      |
|--------------------------------|------|--|------|
| 1. Engine oil dipstick .....   | 9-15 | 6. Windshield washer fluid reservoir ..... | 9-21 |
| 2. Brake fluid reservoir ..... | 9-20 | 7. Fuse box .....                          | 9-43 |
| 3. Air cleaner .....           | 9-22 | 8. Battery .....                           | 9-27 |
| 4. Engine oil filler cap ..... | 9-15 | 9. Radiator cap .....                      | 9-18 |
| 5. Engine oil filler cap ..... | 9-15 |  |      |

## DIMENSIONS

Items		in. (mm)
Overall length		184.1 (4,676)
Overall width		72 (1,825)
Overall height		55.7 (1,415)
Front tread	195/65 R15	62.7 (1,593)
	205/55 R16	62.4 (1,585)
	225/45 R17	62.2 (1,579)
	235/40 R18	61.7 (1,566)
Rear tread	195/65 R15	63.1 (1,604)
	205/55 R16	62.8 (1,596)
	225/45 R17	62.6 (1,590)
	235/40 R18	62.2 (1,581)
Wheelbase		107 (2,720)

## ENGINE SPECIFICATION

Item		Smartstream G 2.0 Atkinson	Smartstream G1.6 T-GDi
Displacement	cu. in. (cc)	121.99 (1,999)	97.52 (1,598)
Bore x Stroke	in. (mm)	3.19 X 3.81 (81.0 X 97.0)	2.98 X 3.50 (75.6 X 89.0)
Firing order		1-3-4-2	1-3-4-2
No. of cylinders		4, in-line	4, in-line

## BULB WATTAGE

Light bulb			Bulb type	Wattage	
Front	Type A	Headlamp	High	HB3	60
			Low	HB3	60
		Daytime running lamp (DRL)/Parking lamp		LED	LED
	Type B	Headlamp	High	LED	LED
			Low		
	Daytime running lamp (DRL)/Parking lamp		LED	LED	
	Side marker		Bulb type	W5W	5
			LED type	LED	LED
Turn signal lamp			PY21W	21	
Side repeater lamp (Outside mirror)			LED	LED	
Rear	Type A	Stop lamp		P21W/5W	21
		Tail lamp	Inner	W5W	5
			Outer	P21/5W	5
	Type B	Stop lamp		P21W/5W	21
		Tail lamp		LED	LED
	Type C	Stop lamp		LED	LED
		Tail lamp		LED	LED
	Side marker		Bulb type	W5W	5
			LED type	LED	LED
	Turn signal lamp			PY21W	21
	License plate lamp			W5W	5
Reverse lamp			W16W	16	
High mounted stop lamp			P21W	21	
Interior	Map lamp			W10W	10
	Room lamp			FESTOON	8
	Vanity mirror lamp			FESTOON	5
	Trunk room lamp			FESTOON	5

## TIRES AND WHEELS

Item	Tire Size	Wheel Size	Inflation pressure psi (kPa)		Wheel lug nut torque kgf·m (lbf·ft, N·m)
			Front	Rear	
Full size tire	195/65 R15	6.0Jx15	34 (235)	31 (215)	11-13 (79-94, 107-127)
	205/55 R16	6.5Jx16	34 (235)	31 (215)	
	225/45 R17	7.0Jx17	34 (235)	31 (215)	
	235/40 R18	8.0Jx18	33 (230)	33 (230)	
Compact spare tire	T125/80 D15	4Tx15	60 (420)	60 (420)	
	T125/80 D16	4TX16	60 (420)	60 (420)	

### NOTICE

- It is permissible to add 3 psi to the standard tire pressure specification if colder temperatures are expected soon.  
Tires typically lose 1psi (7kPa) for every 12°F temperature drop. If extreme temperature variations are expected, recheck your tire pressure as necessary to keep them properly inflated.
- Tire inflation pressures will vary with changes in elevation. If driving in areas of higher or lower elevation, be sure to check and adjust for proper tire inflation.



### CAUTION

- When replacing tires, use the same size originally supplied with the vehicle. Using tires of a different size can damage the related parts or not work properly.
- When replacing tires, ALWAYS use the same size, type, construction and tread pattern supplied with the vehicle for all tires.



## VOLUME AND WEIGHT

Items	Smartstream G2.0 Atkinson		Smartstream G1.6 T-GDi	
	M/T	IVT	M/T	DCT
Gross vehicle weight lbs. (kg)	3,814 (1,730)	3,858 (1,750)	4,012 (1,820)	4,078 (1,850)
Luggage volume cu ft (ℓ)	16.7 (474)			

M/T : Manual transmission, IVT : Intelligent variable transmission

## AIR CONDITIONING SYSTEM

Item	Weight of Volume	Classification
Refrigerant oz. (g)	17.6±0.88 (500±25)	R-1234yf
Compressor lubricant oz. (g)	3.4 ± 0.3 (100 ± 10g)	PAG (FD46XG)

Contact an authorized HYUNDAI dealer for more details.

## RECOMMENDED LUBRICANTS AND CAPACITIES

To help achieve proper engine and powertrain performance and durability, use only lubricants of the proper quality. The correct lubricants also help promote engine efficiency that results in improved fuel economy.

These lubricants and fluids are recommended for use in your vehicle.

Lubricant		Volume	Classification
Engine oil *1 (drain and refill) 	Smartstream G 2.0 Atkinson	4.54 US qt. (4.3 ℓ)	SAE 0W-20, API SN PLUS/SP or ILSAC GF-6 *1
	Smartstream G1.6 T-GDi	5.07 US qt. (4.8 ℓ)	SAE 0W-20, API SN PLUS/SP or ILSAC GF-6
Manual transmission fluid		1.6~1.7 US qt. (1.5~1.6 ℓ)	HK SYN MTF 70W, SPIRAX S6 GHME 70W MTF, GS MTF HD 70W (API GL-4, SAE 70W, TGO-9)
Intelligent variable transmission fluid		6.87 US qt. (6.5 ℓ)	Hyundai genuine SP-CVT1
Dual clutch transmission fluid		1.7~1.8 US qt. (1.6~1.7 ℓ)	API GL-4, SAE 70W, HK D DCTF TGO-10 (SK), SPIRAX S6 GHDE 70W DCTF (H.K.SHELL), 7 DCTF HKM (S-OIL)
Coolant	Smartstream G 2.0 Atkinson	7.82 US qt. (7.4 ℓ)	Mixture of antifreeze and water (Phosphate-based Ethylene glycol coolant for aluminum radiator)
	Smartstream G 1.6 T-GDi	7.19 US qt. (6.8 ℓ)	
Brake/clutch fluid		0.74~0.85 US qt. (0.7~0.8 ℓ)	DOT-4 *2
Fuel		49.66 US qt. (47 ℓ)	Refer to "Fuel requirements" in the Foreword chapter.

\*1: Refer to the recommended SAE viscosity numbers on page 12.

\*2: To maintain the best braking performance and ABS/ESC performance, we recommend that you use genuine brake fluid that conform to specifications. (Standard : SAE J1704 DOT-4 LV, ISO4925 CLASS-6 and FMVSS 116 DOT-4)

### Recommended SAE Viscosity Number



#### CAUTION

**Always be sure to clean the area around any filler plug, drain plug, or dipstick before checking or draining any lubricant. This is especially important in dusty or sandy areas and when the vehicle is used on unpaved roads. Cleaning the plug and dipstick areas will prevent dirt and grit from entering the engine and other mechanisms that could be damaged.**

Engine oil viscosity (thickness) has an effect on fuel economy and cold weather operating (engine start and engine oil flowability). Lower viscosity engine oils can provide better fuel economy and cold weather performance, however, higher viscosity engine oils are required for satisfactory lubrication in hot weather.

Using oils of any viscosity other than those recommended could result in engine damage.

When choosing an oil, consider the range of temperature your vehicle will be operated in before the next oil change. Proceed to select the recommended oil viscosity from the chart.

**Temperature Range for SAE Viscosity Numbers**

Temperature	°C	-30	-20	-10	0	10	20	30	40	50	
	(°F)	-10	0	20	40	60	80	100	120		
Engine Oil *1	Smartstream G2.0 Atkinson/ Smartstream G1.6 T-GDi	<b>0W-20</b>									

\*1: Requires <API SN PLUS (or above)> grade engine oil. If a lower grade engine oil (mineral oil) is used, then the engine oil and engine oil filter must be replaced as indicated for severe maintenance condition.



An engine oil displaying this American Petroleum Institute (API) Certification Mark conforms to the International Lubricant Specification Advisory Committee (ILSAC). It is recommended to only use engine oils that uphold this API Certification Mark.

### VEHICLE IDENTIFICATION NUMBER (VIN)



The VIN is also on a plate attached to the top of the dashboard. The number on the plate can easily be seen through the windshield from outside.

### VEHICLE CERTIFICATION LABEL

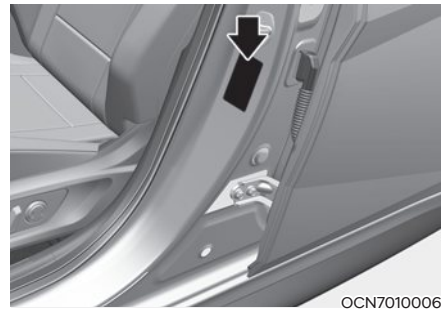

The vehicle certification label attached on the driver's side center pillar gives the Vehicle Identification Number (VIN).

## TIRE SPECIFICATION AND PRESSURE LABEL



The tires supplied on your new vehicle are chosen to provide the best performance for normal driving. The tire label located on the driver's side center pillar gives the tire pressures recommended for your car.

## ENGINE NUMBER

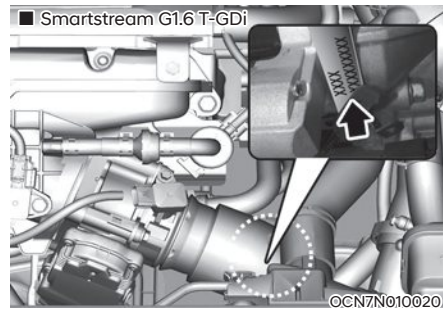
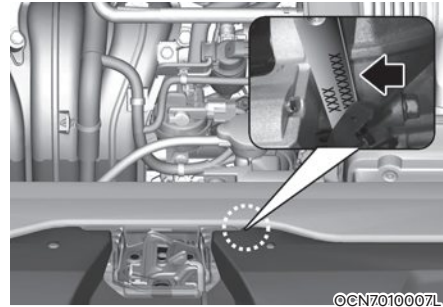

The engine number is stamped on the engine block as shown in the drawing.

## CONSUMER INFORMATION

This consumer information has been prepared in accordance with regulations issued by the National Highway Traffic Safety Administration of the U.S. Department of Transportation. Your HYUNDAI dealer will help answer any questions you may have as you read this information.

HYUNDAI motor vehicles are designed and manufactured to meet or exceed all applicable safety standards.

For your safety, however, we strongly urge you to read and follow all directions in this Owner's Manual, particularly the information under the headings "**NOTICE**", "**CAUTION**" and "**WARNING**".

If, after reading this manual, you have any questions regarding the operation of your vehicle, please contact the Hyundai Customer Care Center.

Hyundai Customer Care  
P.O. Box 20850  
Fountain Valley, CA 92728  
800-633-5151  
[consumeraffairs@hmausa.com](mailto:consumeraffairs@hmausa.com)

Hyundai's Customer Care Center representatives are available Monday through Friday, between the hours of 6:00 AM and 5:00 PM PST and Saturday between 6:30 AM and 3:00 PM PST (English).

For Customer Care Center assistance in Spanish or Korean, representatives are available Monday through Friday between 6:30 AM and 3:00 PM PST.

## **REPORTING SAFETY DEFECTS**

If you believe that your vehicle has a defect which could cause a crash or could cause injury or death, you should immediately inform the National Highway Traffic Safety Administration (NHTSA) in addition to notifying HYUNDAI MOTOR AMERICA.

To contact NHTSA, you may call the Vehicle Safety Hotline toll-free at 1-888-327-4236 (TTY: 1-800-424-9153);

go to <http://www.safercar.gov>;

download the SaferCar mobile application;

or write to: Administrator, NHTSA

1200 New Jersey Ave, SE,

West Building Washington, D.C. 20590.

You can also obtain other information about motor vehicle safety from <http://www.safercar.gov>.

If NHTSA receives similar complaints, it may open an investigation, and if it finds that a safety defect exists in a group of vehicles, it may order a recall and remedy campaign. However, NHTSA cannot become involved in individual problems between you, your dealer, or HYUNDAI MOTOR AMERICA.

# 3. Seats & Safety System

This chapter provides you with important information about how to protect yourself and your passengers. It explains how to properly use your seats and seat belts, and how your air bags work. Additionally, this chapter explains how to properly restrain infants and children in your vehicle.

- Important Safety Precautions ..... 3-2
  - Always Wear Your Seat Belt ..... 3-2
  - Restrain All Children..... 3-2
  - Air Bag Hazards ..... 3-2
  - Driver Distraction ..... 3-2
  - Control Your Speed ..... 3-2
  - Keep Your Vehicle in Safe Condition..... 3-2
- Seats ..... 3-3
  - Safety Precautions ..... 3-4
  - Front Seats ..... 3-5
  - Rear Seats ..... 3-10
  - Head Restraints ..... 3-11
  - Seat Warmers ..... 3-15
- Seat Belts ..... 3-17
  - Seat Belt Safety Precautions ..... 3-17
  - Seat Belt Warning Light ..... 3-18
  - Seat Belt Restraint System ..... 3-18
  - Additional Seat Belt Safety Precautions ..... 3-23
  - Care of Seat Belts ..... 3-25
- Child Restraint System (CRS) ..... 3-26
  - Children Always in the Rear ..... 3-26
  - Selecting a Child Restraint System (CRS)..... 3-27
  - Installing a Child Restraint System (CRS) ..... 3-28
- Air Bag - Advanced Supplemental Restraint System ..... 3-35
  - Where Are the Air Bags? ..... 3-37
  - How Does the Air Bag System Operate?..... 3-40
  - What to Expect After an Air Bag Inflates ..... 3-43
  - Occupant Classification System (OCS)..... 3-44
  - Why Didn't My Air Bag Go Off in a Collision? ..... 3-50
  - SRS Care ..... 3-54
  - Additional Safety Precautions ..... 3-55
  - Air Bag Warning Labels ..... 3-55



## IMPORTANT SAFETY PRECAUTIONS

You will find many safety precautions and recommendations throughout this section, and throughout this manual. The safety precautions in this section are among the most important.

### Always Wear Your Seat Belt

A seat belt is your best protection in all types of accidents. Air bags are designed to supplement seat belts, not replace them. So even though your vehicle is equipped with air bags, ALWAYS make sure you and your passengers wear your seat belts, and wear them properly.

### Restrain All Children

All children under age 13 should ride in your vehicle properly restrained in a rear seat, not the front seat. Infants and small children should be restrained in an appropriate child restraint. Larger children should use a booster seat with the lap/shoulder belt until they can use the seat belt properly without a booster seat.

### Air Bag Hazards

While air bags can save lives, they can also cause serious or fatal injuries to occupants who sit too close to them, or who are not properly restrained. Infants, young children, and shorter adults are at the greatest risk of being injured by an inflating air bag. Follow all instructions and warnings in this manual.

### Driver Distraction

Driver distraction presents a serious and potentially deadly danger, especially for inexperienced drivers. Safety should be the first concern when behind the wheel, and drivers need to be aware of the wide array of potential distractions, such as drowsiness, reaching for objects, eating, personal grooming, other passengers, and using cellular phones.

Drivers can become distracted when they take their eyes and attention off the road or their hands off the wheel to focus on activities other than driving. To reduce your risk of distraction or getting into an accident:

- ALWAYS set up your mobile devices (i.e., MP3 players, phones, navigation units, etc.) when your vehicle is parked or safely stopped.
- ONLY use your mobile device when allowed by laws and when conditions permit safe use. NEVER text or email while driving. Most states have laws prohibiting drivers from texting. Some states and cities also prohibit drivers from using handheld phones.
- NEVER let the use of a mobile device distract you from driving. You have a responsibility to your passengers and others on the road to always drive safely, with your hands on the wheel as well as your eyes and attention on the road.

### Control Your Speed

Excessive speed is a major factor in crash injuries and deaths. Generally, the higher the speed, the greater the risk, but serious injuries can also occur at lower speeds. Never drive faster than is safe for current conditions, regardless of the maximum speed posted.

### Keep Your Vehicle in Safe Condition

Having a tire blowout or a mechanical failure can be extremely hazardous. To reduce the possibility of such problems, check your tire pressures and condition frequently, and perform all regularly scheduled maintenance.

## SEATS



OCN7030001

**Driver's seat**

- (1) Forward and rearward
- (2) Seatback angle
- (3) Seat cushion height
- (4) Seat cushion angle
- (5) Lumbar support

**Front passenger's seat**

- (1) Forward and rearward
- (2) Seatback angle

### Safety Precautions

Adjusting the seats so that you are sitting in a safe, comfortable position plays an important role in driver and passenger safety together with the seat belts and air bags in an accident.



#### WARNING

**Do not use a cushion that reduces friction between the seat and the passenger. The passenger's hips may slide under the lap portion of the seat belt during an accident or a sudden stop. Serious or fatal internal injuries could result because the seat belt cannot operate properly.**

#### Air bags

You can take steps to reduce the risk of being injured by an inflating air bag. Sitting too close to an air bag greatly increases the risk of injury in the event the air bag inflates.

The National Highway Traffic Safety Administration (NHTSA) recommends that drivers allow at least 10 inches (25 cm) between the center of the steering wheel and their chest.



#### WARNING

**To reduce the risk of serious injury or death from an inflating air bag, take the following precautions:**

- **Adjust the driver's seat as far to the rear as possible while maintaining the ability to maintain full control of the vehicle.**
- **Adjust the front passenger seat as far to the rear as possible.**
- **Hold the steering wheel by the rim with hands at the 9 o'clock and 3 o'clock positions to minimize the risk of injuries to your hands and arms.**

- **NEVER place anything or anyone between the steering wheel and the air bag.**
- **Do not allow the front passenger to place feet or legs on the dashboard to minimize the risk of leg injuries.**

#### Seat belts

Always fasten your seat belt before starting any trip.

At all times, passengers should sit upright and be properly restrained. Infants and small children must be restrained in appropriate child restraint systems. Adults and children who have outgrown a booster seat must be restrained using the seat belts.



#### WARNING

**Take the following precautions when adjusting your seat belt:**

- **NEVER use one seat belt for more than one occupant.**
- **Always position the seatback upright with the lap portion of the seat belt snug and low across the hips.**
- **NEVER allow children or small infants to ride on a passenger's lap.**
- **Do not route the seat belt across your neck, across sharp edges, or reroute the shoulder strap away from your body.**
- **Do not allow the seat belt to become caught or jammed.**

## Front Seats



### WARNING

Take the following precautions when adjusting your seat:

- **NEVER attempt to adjust the seat while the vehicle is moving.** The seat could respond with unexpected movement and may cause loss of vehicle control resulting in an accident.
- **Do not place anything under the front seats.** Loose objects in the driver's foot area could interfere with the operation of the foot pedals, causing an accident.
- **Do not allow anything to interfere with the normal position and proper locking of the seatback.**
- **Do not place a cigarette lighter on the floor or seat.** When you operate the seat, gas may exit out of the lighter causing a fire.
- **Use extreme caution when picking up small objects trapped under the seats or between the seat and the center console.** Your hands might be cut or injured by the sharp edges of the seat mechanism.
- **If there are occupants in the rear seats, be careful while adjusting the front seat position.**
- **Make sure that the seat is locked in place after the adjustment.** If not, the seat might move unexpectedly resulting in an accident.



### CAUTION

To prevent injury:

- **Do not adjust your seat while wearing your seat belt.** Moving the seat cushion forward may cause strong pressure on your abdomen.
- **Do not allow your hands or fingers to get caught in the seat mechanisms while the seat is moving.**

### Manual adjustment (if equipped)

The front seat can be adjusted by using the levers located on the outside of the seat cushion. Before driving, adjust the seat to the proper position so that you can easily control the steering wheel, foot pedals and controls on the instrument panel.

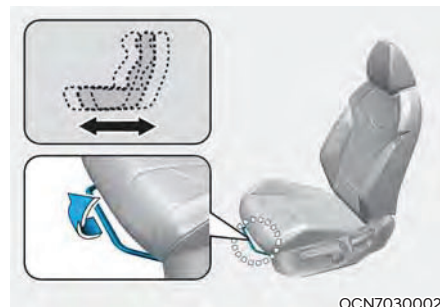

#### Forward and rearward adjustment

To move the seat forward or rearward:

1. Pull up the seat slide adjustment lever and hold it.
2. Slide the seat to the position you desire.
3. Release the lever and make sure the seat is locked in place. Move forward and rearward without using the lever. If the seat moves, it is not locked properly.

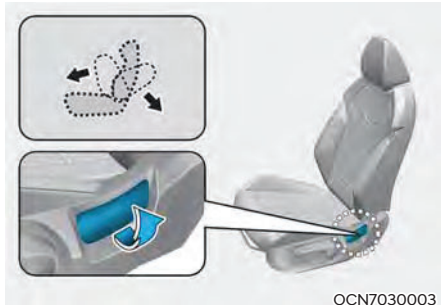

### Seatback angle

To recline the seatback:

1. Lean forward slightly and lift up the seatback lever.
2. Carefully lean back on the seat and adjust the seatback to the position you desire.
3. Release the lever and make sure the seatback is locked in place. (The lever **MUST** return to its original position for the seatback to lock.)

### Reclining seatback

Sitting in a reclined position when the vehicle is in motion can be dangerous. Even when buckled up, the protection of your restraint system (seat belts and air bags) is greatly reduced by reclining your seatback.

### **WARNING**

**NEVER** ride with a reclined seatback when the vehicle is moving.

**Riding with a reclined seatback increases your chance of serious or fatal injuries in the event of a collision or sudden stop.**

**Drivers and passengers should ALWAYS sit well back in their seats, properly belted, and with the seatbacks upright.**

Seat belts must be snug against your hips and chest to work properly. When the seatback is reclined, the shoulder belt cannot do its job because it will not be snug against your chest. Instead, it will be in front of you. During an accident, you could be thrown into the seat belt, causing neck or other injuries. The more the seatback is reclined, the greater chance the passenger's hips will slide under the lap belt or the passenger's neck will strike the shoulder belt.

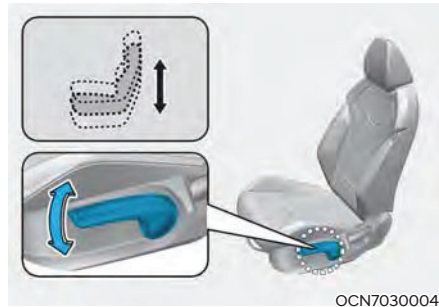

### Seat cushion height (for driver's seat, if equipped)

To change the height of the seat cushion:

- Push down on the lever several times, to lower the seat cushion.
- Pull up on the lever several times, to raise the seat cushion.

**Power adjustment (if equipped)**

The front seat can be adjusted by using the control switches located on the outside of the seat cushion. Before driving, adjust the seat to the proper position so that you can easily control the steering wheel, foot pedals and controls on the instrument panel.

**WARNING**

**NEVER** allow children in the vehicle unattended. The power seats are operable when the vehicle is turned off.

**NOTICE**

To prevent damage to the seats:

- Always stop adjusting the seats when the seat has moved as far forward or rearward as possible.
- Do not adjust the seats for longer than necessary when the vehicle is turned off. This may result in unnecessary battery drain.
- Do not operate two or more seats at the same time. This may result in an electrical malfunction.

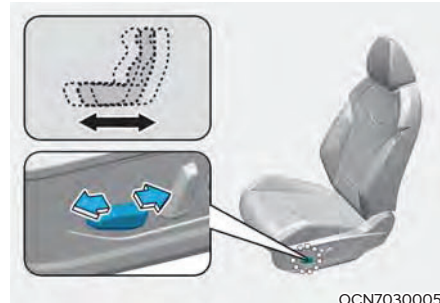

OCN7030005

**Forward and rearward adjustment**

To move the seat forward or rearward:

1. Push the control switch forward or rearward.
2. Release the switch once the seat reaches the desired position.

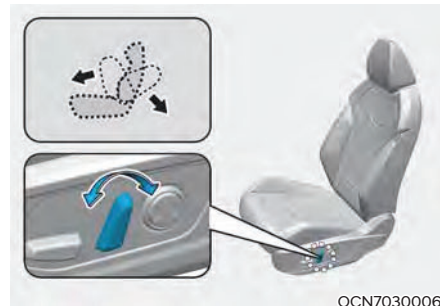

OCN7030006

**Seatback angle**

To adjust the seatback:

1. Rotate the top of control switch forward or rearward.
2. Release the switch once the seatback reaches the desired position.

### Reclining seatback

Sitting in a reclined position when the vehicle is in motion can be dangerous. Even when buckled up, the protection of your restraint system (seat belts and air bags) is greatly reduced by reclining your seatback.

### WARNING

**NEVER ride with a reclined seatback when the vehicle is moving. Riding with a reclined seatback increases your chance of serious or fatal injuries in the event of a collision or sudden stop. Driver and passengers should ALWAYS sit well back in their seats, properly belted, and with the seatbacks upright.**

Seat belts must be snug against your hips and chest to work properly. When the seatback is reclined, the shoulder belt cannot do its job because it will not be snug against your chest. Instead, it will be in front of you. During an accident, you could be thrown into the seat belt, causing neck or other injuries. The more the seatback is reclined, the greater chance the passenger's hips will slide under the lap belt or the passenger's neck will strike the shoulder belt.

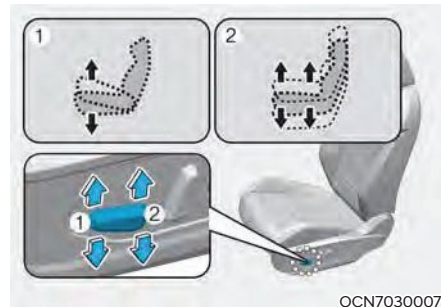

### Seat cushion tilt (1) (if equipped)

To change the angle of the front part of the seat cushion: Push the front portion of the control switch up to raise or down to lower the front part of the seat cushion. Release the switch once the seat reaches the desired position.

### Seat cushion height (2) (if equipped)

To change the height of the seat cushion: Push the rear portion of the control switch up to raise or down to lower the height of the seat cushion. Release the switch once the seat reaches the desired position.

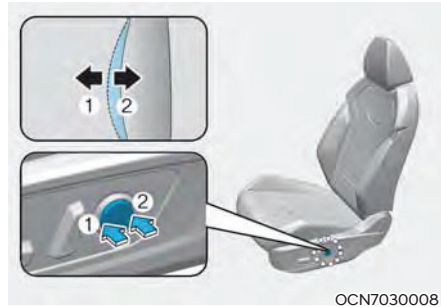

#### Lumbar support (for driver's seat, if equipped)

The lumbar support can be adjusted by pressing the lumbar support switch. Press the front portion of the switch (1) to increase support or the rear portion of the switch (2) to decrease support.

#### Seatback pocket (if equipped)

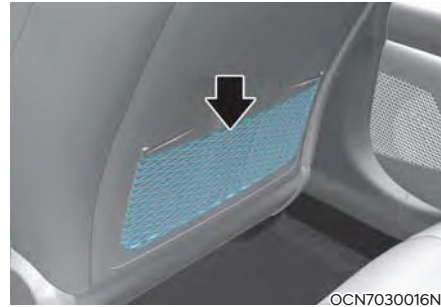

The seatback pocket is provided on the back of the front seatbacks.

#### **WARNING**

To prevent the Occupant Classification System from malfunctioning:

Do not hang onto the front passenger's seatback.

#### **CAUTION**

Do not put heavy or sharp objects in the seatback pockets. In an accident they could come loose from the pocket and injure occupants.



## Rear Seats

### Folding the rear seat (if equipped)

The rear seatbacks can be folded to facilitate carrying long items or to increase the luggage capacity of the vehicle.

#### WARNING

- Never allow passengers to sit on top of the folded down seatback while the vehicle is moving. This is not a proper seating position and no seat belts are available for use. This could result in serious injury or death in case of an accident or sudden stop.
- Objects carried on the folded down seatback should not extend higher than the top of the front seatbacks. This could allow cargo to slide forward and cause injury or damage during sudden stops.

To fold down the rear seatback:

1. Set the front seatback to the upright position and if necessary, slide the front seat forward.

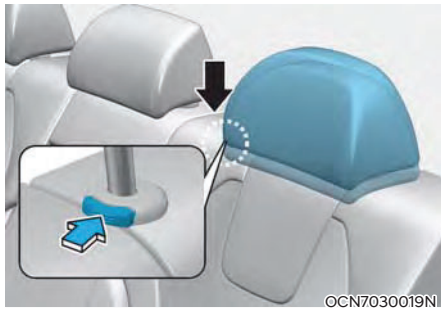

2. Lower the rear head restraints to the lowest position by pushing and holding the release button and pushing down on the head restraint.



3. Pull on the seatback folding lever located in the trunk.

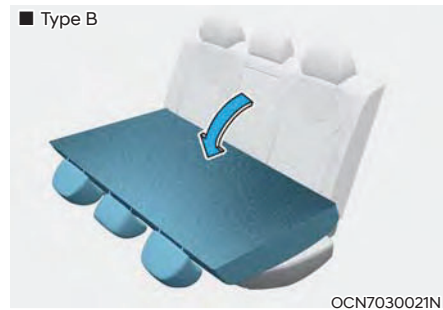
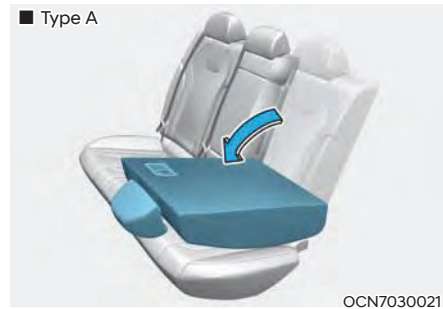

4. Fold the seatback toward the front of the vehicle.
5. To use the rear seat, lift and pull the seatback rearward. Pull the seatback firmly until it clicks into place. Make sure the seatback is locked in place.

**⚠ WARNING**

When returning the rear seatback from a folded to an upright position, hold the seatback and return it slowly. Ensure that the seatback is completely locked into its upright position by pushing on the top of the seatback. In an accident or sudden stop, an unlocked seatback could allow cargo to move forward with great force and enter the passenger compartment, which could result in serious injury or death.

**⚠ WARNING**

Do not place objects in the rear seats, since they cannot be properly secured and may hit vehicle occupants in a collision causing serious injury or death.

**⚠ WARNING**

Make sure the vehicle is off, the shift button is in P (Park), and the parking brake is securely applied whenever loading or unloading cargo. Failure to take these steps may allow the vehicle to move if the shift button is inadvertently moved to another position.

**Armrest (if equipped)**

The armrest is located in the center of the rear seat. Pull the armrest down from the seatback to use it.

**Head Restraints**

The vehicle's front and rear seats have adjustable head restraints. The head restraints provide comfort for passengers, but more importantly they are designed to help protect passengers from whiplash and other neck and spinal injuries during an accident, especially in a rear impact collision.

**⚠ WARNING**

To reduce the risk of serious injury or death in an accident, take the following precautions when adjusting your head restraints:

- Always properly adjust the head restraints for all passengers **BEFORE** starting the vehicle.
- **NEVER** let anyone ride in a seat with the head restraints removed or reversed.

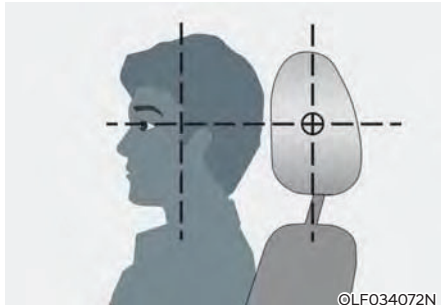

- Adjust the head restraints so the middle of the head restraint is at the same height as the height of the top of the eyes.
- NEVER adjust the head restraint position of the driver's seat when the vehicle is in motion.
- Adjust the head restraint as close to the passenger's head as possible. Do not use a seat cushion that holds the body away from the seatback.
- Make sure the head restraint locks into position after adjusting it.

**NOTICE**

To prevent damage, NEVER hit or pull on the head restraints.

**CAUTION**

When there are no occupants in the rear seats, adjust the height of the head restraint to the lowest position. The rear seat head restraint can reduce the visibility of the rear area.

**Front seat head restraints**

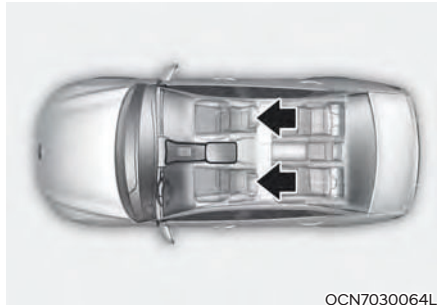

Both the driver's and passenger's front seat are equipped with adjustable head restraints for the safety and comfort.

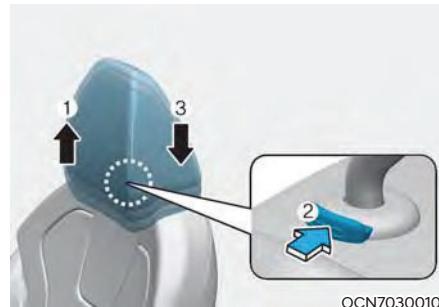

**Adjusting the height up and down**

To raise the head restraint:

1. Pull it up to the desired position (1).

To lower the head restraint:

1. Push and hold the release button (2) on the head restraint support.
2. Lower the head restraint to the desired position (3).



#### Forward and rearward adjustment (if equipped)

The head restraint can be adjusted forward to 3 different positions by pulling the head restraint forward to the desired detent. To adjust the head restraint to its furthest rearwards position, pull it fully forward to the farthest position and release it.

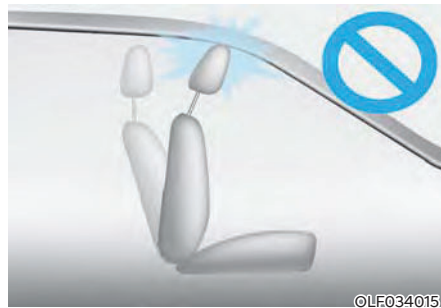

#### **NOTICE**

If you recline the seatback towards the front with the head restraint and seat cushion raised, the head restraint may come in contact with the sunvisor or other parts of the vehicle.

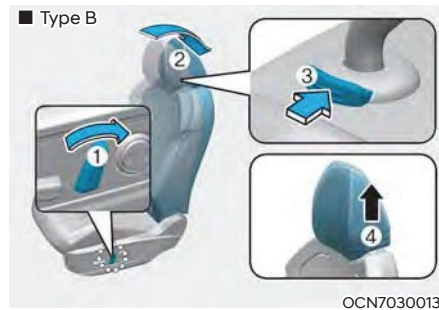
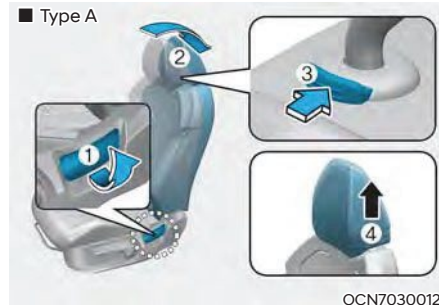

#### Removal/Reinstallation

To remove the head restraint:

1. Recline the seatback (2) rearward using the seatback angle lever (1).
2. Raise the head restraint as far as it can go.
3. Press the head restraint release button (3) while pulling the head restraint up (4).

#### **WARNING**

**NEVER** allow anyone to travel in a seat with the head restraint removed.

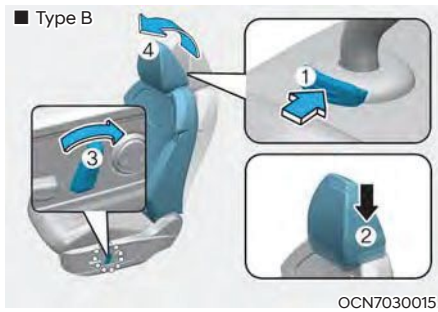
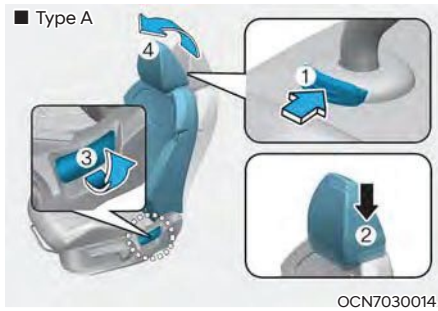

To reinstall the head restraint:

1. Put the head restraint poles (2) into the holes while pressing the release button (1).
2. Adjust the head restraint to the appropriate height.
3. Adjust the seatback (4) forward using the seatback angle lever (3).

**⚠ WARNING**

**Always make sure the head restraint locks into position after reinstalling and adjusting it properly.**

**Rear seat head restraints**

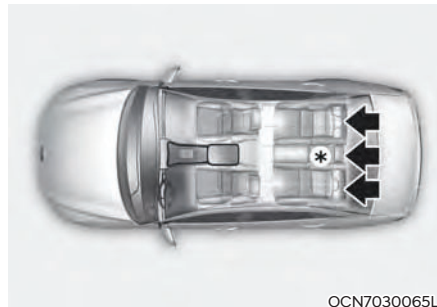

The rear seats are equipped with head restraints in all the seating positions for the passenger's safety and comfort.

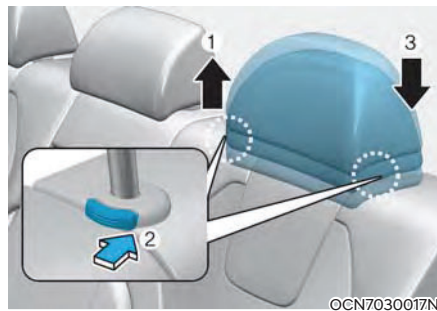

**Adjusting the height up and down (if equipped)**

To raise the head restraint:

1. Pull it up to the desired position (1).

To lower the head restraint:

1. Push and hold the release button (2) on the head restraint support.
2. Lower the head restraint to the desired position (3).

## Seat Warmers

### *Front seat warmers (if equipped)*

Seat warmers are provided to warm the seats during cold weather.

#### **WARNING**

The seat warmers can cause a **SERIOUS BURN**, even at low temperatures and especially if used for long periods of time.

Passengers must be able to feel if the seat is becoming too warm so they can turn it off, if needed.

People who cannot detect temperature change or pain to the skin should use extreme caution, especially the following types of passengers:

- Infants, children, elderly or disabled persons, or hospital outpatients.
- People with sensitive skin or who burn easily.
- Fatigued individuals.
- Intoxicated individuals.
- People taking medication that can cause drowsiness or sleepiness.

#### **WARNING**

**NEVER** place anything on the seat that insulates against heat when the seat warmer is in operation, such as a blanket or seat cushion. This may cause the seat warmer to overheat, causing a burn or damage to the seat.

#### **NOTICE**

To prevent damage to the seat warmers and seats:

- Never use a solvent such as paint thinner, benzene, alcohol or gasoline to clean the seats.
- Do not place heavy or sharp objects on seats equipped with seat warmers.
- Do not change the seat cover. It may damage the seat warmer or air ventilation system.



OCN7030024

While the engine is running, push either of the switches to warm the driver's seat or front passenger's seat.

During mild weather or under conditions where the operation of the seat warmer is not needed, keep the switches in the OFF position.

- Manual temperature control  
Each time you push the switch, the temperature setting of the seat is changed as follows:

- Front seat

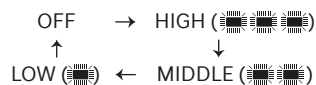

- Automatic temperature control  
The seat warmer starts to automatically control the seat temperature in order to prevent low-temperature burns after being manually turned ON.

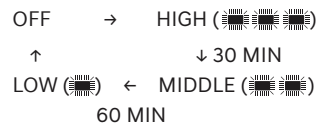

You may manually press the switch to increase seat temperature. However, it soon returns the automatic mode again.

- When pressing the switch for more than 1.5 seconds with the seat warmer operating, the seat warmer will turn OFF.
- The seat warmer defaults to the OFF position whenever the ignition switch is in the ON position. However, if the Auto Comfort Control function is ON, the driver's seat warmer will turn on and off depending on the ambient temperature.
- Auto Comfort Control (for driver's seat, if equipped)  
The seat warmer automatically controls the seat temperature depending on the ambient temperature when the engine is running. If the seat warmer switch is pushed, the seat warmer will have to be controlled manually. To use this function, it must be activated from the Settings menu in the AVN system screen. For more details, refer to the separately supplied Car Infotainment System manual.

## SEAT BELTS

This section describes how to use the seat belts properly. It also describes some of the things to avoid when using seat belts.

### Seat Belt Safety Precautions

Always fasten your seat belt and make sure all passengers have fastened their seat belts before starting any trip. Air bags are designed to supplement the seat belt as an additional safety device, but they are not a substitute. Most states require all occupants of a vehicle to wear seat belts.



#### **WARNING**

Seat belts must be used by **ALL** passengers whenever the vehicle is moving. Take the following precautions when adjusting and wearing seat belts:

- **ALWAYS** properly restrain children under age 13 in the rear seats.
- **NEVER** allow children to ride in the front passenger seat. If a child age 13 or older must be seated in the front seat, move the seat as far back as possible and properly restrain them in the seat.
- **NEVER** allow an infant or child to be carried on an occupant's lap.
- **NEVER** ride with the seatback reclined when the vehicle is moving.
- Do not allow children to share a seat or seat belt.
- Do not wear the shoulder belt under your arm or behind your back.
- Always wear both the shoulder portion and lap portion of the lap/shoulder belt.
- Do not use the seat belt if it is twisted. A twisted seat belt will not protect you properly in an accident.
- Do not use a seat belt if the webbing or hardware is damaged.

- Do not latch the seat belt into the buckles of other seats.
- **NEVER** unfasten the seat belt while driving. This may cause loss of vehicle control resulting in an accident.
- Make sure there is nothing in the buckle interfering with the seat belt latch mechanism. This may prevent the seat belt from fastening securely.
- No modifications or additions should be made by the user which will either prevent the seat belt adjusting devices from operating to remove slack, or prevent the seat belt assembly from being adjusted to remove slack.



#### **WARNING**

Damaged seat belts and seat belt assemblies will not operate properly. Always replace:

- Frayed, contaminated, or damaged webbing
- Damaged hardware
- The entire seat belt assembly after it has been worn in an accident, even if damage to webbing or assembly is not apparent



## Seat Belt Warning Light

### Seat belt warning



#### Driver's and Passenger's front seat belt warning

As a reminder, the seat belt warning light will illuminate for approximately 6 seconds each time you turn the ignition switch or ENGINE START/STOP button ON regardless of belt fastening. If the seatbelt is not fastened, the warning chime will sound for about 6 seconds.

If you start to drive without the seat belt fastened over approximately 5 mph (9 km/h) and less than approximately 12 mph (20 km/h), the corresponding warning light will illuminate. The warning light will turn off when the vehicle speed drops below approximately 5 mph (9 km/h).

If you start to drive without the seat belt fastened or you unfasten the seat belt when you drive approximately 12 mph (20 km/h) and faster, the warning light will blink and warning chime will sound for approximately 100 seconds.

When the seat belt is unfastened during driving, the warning light will illuminate when the speed is over approximately 5 mph (9 km/h) and less than approximately 12 mph (20 km/h). When the speed is approximately 12 mph (20 km/h) and faster, the warning light will blink and warning chime will sound for approximately 100 seconds.

## Seat Belt Restraint System

### WARNING

Improperly positioned seat belts may increase the risk of serious injury in an accident. Take the following precautions when adjusting the seat belt:

- Position the lap portion of the seat belt as low as possible across your hips, not on your waist, so that it fits snugly.
- Position one arm under the shoulder belt and the other over the belt, as shown in the illustration.
- Always position the shoulder belt anchor into the locked position at the appropriate height.
- NEVER position the shoulder belt across your neck or face.

### Seat Belt-Driver's 3-point system with emergency locking retractor

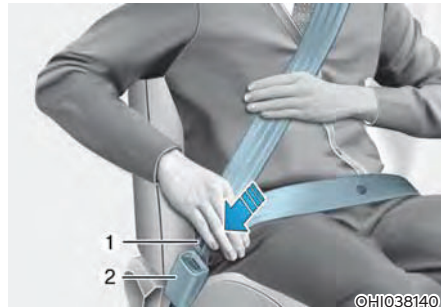

#### To fasten your seat belt:

Pull the seat belt out of the retractor and insert the metal tab (1) into the buckle (2). There will be an audible “click” when the tab locks into the buckle.

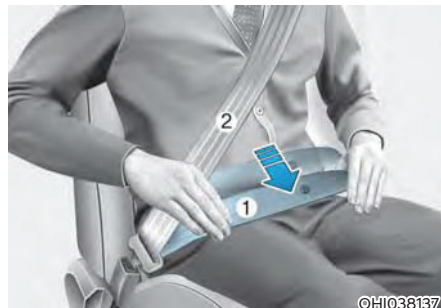

You should place the lap belt (1) portion across your hips and the shoulder belt (2) portion across your chest.

The seat belt automatically adjusts to the proper length after the lap belt portion is adjusted manually so that it fits snugly around your hips. If you lean forward in a slow, easy motion, the belt will extend and move with you.

If there is a sudden stop or impact, the belt will lock into position. It will also lock if you try to lean forward too quickly.

### NOTICE

If you are not able to smoothly pull enough of the seat belt out from the retractor, firmly pull the seat belt out and release it. After release, you will be able to pull the belt out smoothly.

#### Height adjustment

You can adjust the height of the shoulder belt anchor to one of the three different positions for maximum comfort and safety. The shoulder portion should be adjusted so it lies across your chest and midway over your shoulder nearest the door, not over your neck. To adjust the height of the seat belt anchor, lower or raise the height adjuster into an appropriate position.

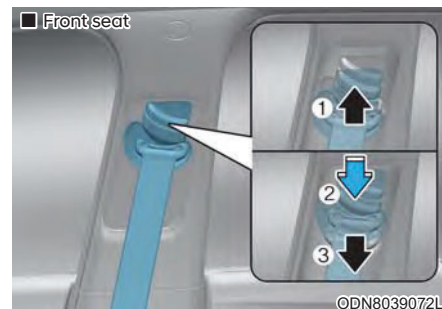

To raise the height adjuster, pull it up (1). To lower it, push it down (3) while pressing the height adjuster button (2). Release the button to lock the anchor into position. Try sliding the height adjuster to make sure that it has locked into position.

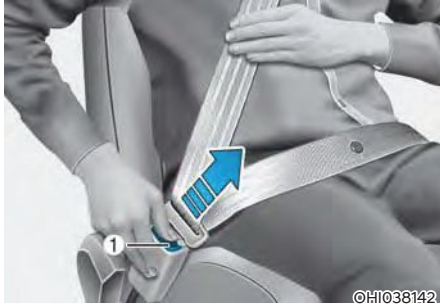

**To release your seat belt:**

Press the release button (1) in the locking buckle.

When it is released, the belt should automatically draw back into the retractor. If this does not happen, check the belt to be sure it is not twisted, then try again.

***Rear Seat Belt – Passenger’s 3-point system with convertible locking retractor***

This type of seat belt combines the features of both an emergency locking retractor seat belt and an automatic locking retractor seat belt. Convertible retractor type seat belts are installed in the rear seat positions to help accommodate the installation of child restraint systems. Although a convertible retractor is also installed in the front passenger seat position, NEVER place any infant/child restraint system in the front seat of the vehicle.

**To fasten your seat belt:**

Pull the seat belt out of the retractor and insert the metal tab into the buckle. There will be an audible “click” when the tab locks into the buckle. When not securing a child restraint, the seat belt operates in the same way as the driver’s seat belt (Emergency Locking Retractor Type). It automatically adjusts to the proper length only after the lap belt portion of the seat belt is adjusted manually so that it fits snugly across your hips.

When the seat belt is fully extended from the retractor to allow the installation of a child restraint system, the seat belt operation changes to allow the belt to retract, but not to extend (Automatic Locking Retractor Type). Refer to the “Using a Child Restraint System” section in this chapter.

**NOTICE**

**Although the seat belt retractor provides the same level of protection for seated passengers in either emergency or automatic locking modes, the emergency locking mode allows seated passengers to move freely in their seat while keeping some tension on the belt. During a collision or sudden stop, the retractor automatically locks the belt to help restrain your body.**

**To deactivate the automatic locking mode, unbuckle the seat belt and allow the belt to fully retract.**

**Rear center seat belt**

OCN7030027L

When using the rear center seat belt, the buckle with the “CENTER” mark must be used.

**WARNING**

**Make sure that the seatback is locked in place when using the rear center seat belt.**

**If not, the seatback may move when there is a sudden stop or collision, which could result in serious injury.**

**Pre-tensioner seat belt  
(Driver and front passenger)**

OH1038143L

Your vehicle is equipped with driver's and front passenger's Pre-tensioner Seat Belts (Retractor Pre-tensioner). The purpose of the pre-tensioner is to make sure the seat belts fit tightly against the occupant's body in certain frontal or side collision(s).

When the vehicle stops suddenly, or if the occupant tries to lean forward too quickly, the seat belt retractor will lock into position. In certain frontal or side collision(s), the pre-tensioner will activate and pull the seat belt into tighter contact against the occupant's body.

If the system senses excessive tension on the driver or passenger's seat belt when the pre-tensioner system activates, the load limiter inside the retractor pre-tensioner will release some of the pressure on the affected seat belt.

 **WARNING**

- Always wear your seat belt and sit properly in your seat.
- Do not use the seat belt if it is loose or twisted. A loose or twisted seat belt will not protect you properly in an accident.
- Do not place anything near the buckle. This may adversely affect the buckle and cause it to function improperly.
- Always replace your pre-tensioners after activation or an accident.
- **NEVER** inspect, service, repair or replace the pre-tensioners yourself. This must be done by an authorized HYUNDAI dealer.
- Do not hit the seat belt assemblies.

 **WARNING**

Do not touch the pre-tensioner seat belt assemblies for several minutes after they have been activated. When the pre-tensioner seat belt mechanism deploys during a collision, the pre-tensioners become hot and can burn you.

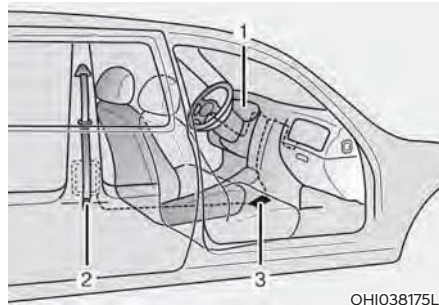

The Pre-Tensioner Seat Belt System consists mainly of the following components. Their locations are shown in the illustration above:

1. SRS air bag warning light
2. Retractor pre-tensioner (front)
3. SRS control module

**NOTICE**

The sensor that activates the SRS air bag is connected with the pre-tensioner seat belts. The SRS air bag warning light on the instrument panel will illuminate for approximately 6 seconds after the ignition switch is in the ON position, and then it should turn off.

If the pre-tensioner is not working properly, the warning light will illuminate even if the SRS air bag is not malfunctioning. If the warning light does not illuminate, stays illuminated or illuminates when the vehicle is being driven, have an authorized HYUNDAI dealer inspect the pre-tensioner seat belts and SRS air bags as soon as possible.

**NOTICE**

- Both the driver's and front passenger's pre-tensioner seat belts may be activated in certain frontal or side collisions or rollovers.
- When the pre-tensioner seat belts are activated, a loud noise may be heard and fine dust, which may appear to be smoke, may be visible in the passenger compartment. These are normal operating conditions and are not hazardous.
- Although it is non-toxic, the fine dust may cause skin irritation and should not be inhaled for prolonged periods. Wash all exposed skin areas thoroughly after an accident in which the pre-tensioner seat belts were activated.

**WARNING**

- Fasten your seat belt while sitting properly in an upright position to maximize the effectiveness of the pre-tensioner seat belt system.
- A pre-tensioner seat belt system is designed to activate only once. Replace the pre-tensioner seat belt system, if it was activated in an accident.

**Additional Seat Belt Safety Precautions****Seat belt use during pregnancy**

The seat belt should always be used during pregnancy. The best way to protect your unborn child is to protect yourself by always wearing the seat belt.

Pregnant women should always wear a lap-shoulder seat belt. Place the shoulder belt across your chest, routed between your breasts and away from your neck. Place the lap belt line so that it fits snugly and as low as possible across the hips, not across the abdomen.

**WARNING**

- A pregnant woman or a patient is more vulnerable to any impacts on the abdomen during an abrupt stop or accident. If you are in an accident while pregnant, we recommend you consult your doctor.
- To reduce the risk of serious injury or death to an unborn child during an accident, pregnant women should **NEVER** place the lap portion of the seat belt above or over the area of the abdomen where the unborn child is located.

**Seat belt use and children****Infant and small children**

All 50 states have child restraint laws which require children to travel in approved child restraint devices, including booster seats. The age at which seat belts can be used instead of child restraints differs among states, so you should be aware of the specific requirements in your state, and where you are travelling. Infant and child restraints must be properly placed and installed in a rear seat. For more information refer to the "Child Restraint Systems" section in this chapter.



**WARNING**

**ALWAYS properly restrain infants and small children in a child restraint appropriate for the child's height and weight.**

**To reduce the risk of serious injury or death to a child and other passengers, NEVER hold a child in your lap or arms when the vehicle is moving. The violent forces created during an accident will tear the child from your arms and throw the child against the interior of the vehicle.**

Small children are best protected from injury in an accident when properly restrained in the rear seat by a child restraint system that meets the requirements of the Federal Motor Vehicle Safety Standards. Before buying any child restraint system, make sure that it has a label certifying that it meets Federal Motor Vehicle Safety Standard FMVSS 213. The restraint must be appropriate for your child's height and weight. Check the label on the child restraint for this information. Refer to the "Child Restraint Systems" section in this chapter.

**Larger children**

Children under age 13 and who are too large for a booster seat must always occupy the rear seat and use the available lap/shoulder belts. A seat belt should lie across the upper thighs and be snug across the shoulder and chest to restrain the child safely. Check belt fit periodically. Children are afforded the most safety in the event of an accident when they are restrained by a proper restraint system and/or seat belts in the rear seat. Always have the LATCH system inspected by your authorized HYUNDAI dealer after an accident. An accident can damage the LATCH system and may not properly secure the child restraint.

If a larger child over age 13 must be seated in the front seat, the child must be securely restrained by the available lap/shoulder belt and the seat should be placed in the rearmost position.

If the shoulder belt portion slightly touches the child's neck or face, try placing the child closer to the center of the vehicle. If the shoulder belt still touches their face or neck, they need to be returned to an appropriate booster seat in the rear seat.



**WARNING**

- **Always make sure children are wearing their seat belts and that they are properly adjusted before driving.**
- **NEVER allow the shoulder belt to contact the child's neck or face.**
- **Do not allow more than one child to use a single seat belt.**

### ***Transporting an injured person***

A seat belt should be used when an injured person is being transported. Consult a physician for specific recommendations.

### ***One person per belt***

Two people (including children) should never attempt to use a single seat belt. This could increase the severity of injuries in case of an accident.

### ***Do not lie down***

Sitting in a reclined position when the vehicle is in motion can be dangerous. Even when buckled up, the protections of your restraint system (seat belts and air bags) is greatly reduced by reclining your seatback.

To reduce the chance of injuries in the event of an accident and to achieve the maximum effectiveness of the restraint system, all passengers should be sitting up and the front and rear seats should be in an upright position when the car is moving.

A seat belt cannot provide proper protection if the person is lying down in the rear seat or if the front or rear seats are in a reclined position.



### **WARNING**

- **NEVER ride with a reclined seatback when the vehicle is moving.**
- **Riding with a reclined seatback increases your chance of serious or fatal injuries in the event of a collision or sudden stop.**
- **Drivers and passengers should always sit well back in their seats, properly belted, and with the seatbacks upright.**

### **Care of Seat Belts**

Seat belt systems should never be disassembled or modified. In addition, care should be taken to assure that seat belts and belt hardware are not damaged by seat hinges, doors or other abuse.

### ***Periodic inspection***

All seat belts should be inspected periodically for wear or damage of any kind. Any damaged parts should be replaced as soon as possible by an authorized HYUNDAI dealer.

### ***Keep belts clean and dry***

Seat belts should be kept clean and dry. If belts become dirty, they can be cleaned by using a mild soap solution and warm water. Bleach, dye, strong detergents or abrasives should not be used because they may damage and weaken the fabric.

### ***When to replace seat belts***

The entire seat belt assembly or assemblies should be replaced if the vehicle has been involved in an accident. This should be done even if no damage is visible. Additional questions concerning seat belt operation should be directed to an authorized HYUNDAI dealer.



## CHILD RESTRAINT SYSTEM (CRS)

### Children Always in the Rear



#### WARNING

**Always properly restrain children in the rear seats of the vehicle.**

**Children of all ages are safer when restrained in the rear seat. A child riding in the front passenger seat can be forcefully struck by an inflating air bag resulting in SERIOUS INJURY or DEATH.**

Children under age 13 must always ride in the rear seats and must always be properly restrained to minimize the risk of injury in an accident, sudden stop or sudden maneuver. According to accident statistics, children are safer when properly restrained in the rear seats than in the front seat. **Even with air bags, children can be seriously injured or killed.** Children too large for a child restraint must use the seat belts provided.

All 50 states have child restraint laws which require children to travel in approved child restraint devices. The laws governing the age or height/weight restrictions at which seat belts can be used instead of child restraints differs among states, so you should be aware of the specific requirements in your state, and where you are travelling.

Child restraint systems must be properly placed and installed in the rear seat. You must use a commercially available child restraint system that meets the requirements of the Federal Motor Vehicle Safety Standards (FMVSS 213).

Child restraint systems are generally designed to be secured in a vehicle seat by lap belt portion of a lap/shoulder belt, or by a LATCH system in the rear seats of the vehicle.

### Child restraint system (CRS)

Infants and younger children must be restrained in an appropriate rear-facing or forward-facing CRS that has first been properly secured to the rear seat of the vehicle. Read and comply with the instructions for installation and use provided by the manufacturer of the child restraint.



#### WARNING

**An improperly secured child restraint can increase the risk of SERIOUS INJURY or DEATH in an accident. Always take the following precautions when using a child restraint system:**

- **NEVER** install a child or infant restraint in the front passenger's seat.
- Always properly secure the child restraint to a rear seat of the vehicle.
- Always follow the child restraint system manufacturer's instructions for installation and use.
- Always properly restrain your child in the child restraint.
- If the vehicle head restraint prevents proper installation of a child seat (as described in the child restraint system manual), the head restraint of the respective seating position shall be readjusted or entirely removed.
- Do not use an infant carrier or a child safety seat that "hooks" over a seatback, it may not provide adequate protection in an accident.
- After an accident, have a **HYUNDAI** dealer check the child restraint system, seat belts, tether anchors and lower anchors.

## Selecting a Child Restraint System (CRS)

When selecting a CRS for your child, always:

- Make sure the CRS has a label certifying that it meets applicable Federal Motor Vehicle Safety Standards (FMVSS 213).
- Select a child restraint based on your child's height and weight. The required label or the instructions for use typically provide this information.
- Select a child restraint that fits the vehicle seating position where it will be used.
- Read and comply with the warnings and instructions for installation and use provided with the child restraint system.

### **Child restraint system types**

There are three main types of child restraint systems: rear-facing seats, forward-facing seats, and booster seats. They are classified according to the child's age, height and weight.

#### Rear-facing child seats



#### **WARNING**

**NEVER** install a child or infant restraint in the front passenger's seat.

**Placing a rear-facing child restraint in the front seat can result in SERIOUS INJURY or DEATH if the child restraint is struck by an inflating air bag.**



A rear-facing child seat provides restraint with the seating surface against the back of the child. The harness system holds the child in place, and in an accident, acts to keep the child positioned in the seat and reduce the stress to the neck and spinal cord.

All children under age one must always ride in a rear-facing infant child restraint.

Convertible and 3-in-1 child seats typically have higher height and weight limits for the rear-facing position, allowing you to keep your child rear-facing for a longer period of time.

Continue to use a rear-facing child seat for as long as your child will fit within the height and weight limits allowed by the child seat manufacturer. It's the best way to keep them safe. Once your child has outgrown the rear-facing child restraint, your child is ready for a forward-facing child restraint with a harness.



#### Forward-facing child restraints

A forward-facing child seat provides restraint for the child's body with a harness. Keep children in a forward-facing child seat with a harness until they reach the top height or weight limit allowed by your child restraint's manufacturer.

Once your child outgrows the forward-facing child restraint, your child is ready for a booster seat.

#### Booster seats

A booster seat is a restraint designed to improve the fit of the vehicle's seat belt system. A booster seat positions the seat belt so that it fits properly over the lap of your child.

Keep your child in a booster seat until they are big enough to sit in the seat without a booster and still have the seat belt fit properly. For a seat belt to fit properly, the lap belt must lie snugly across the upper thighs, not the stomach. The shoulder belt should lie snug across the shoulder and chest and not across the neck or face. Children under age 13 must always ride in the rear seats and must always be properly restrained to minimize the risk of injury.

### Installing a Child Restraint System (CRS)

#### **WARNING**

Before installing your child restraint system always:

- Read and follow the instructions provided by the manufacturer of the child restraint.
- Read and follow the instructions regarding child restraint systems in this manual.

Failure to follow all warnings and instructions could increase the risk of the **SERIOUS INJURY** or **DEATH** if an accident occurs.

#### **WARNING**

If the vehicle head restraint prevents proper installation of a child seat as described in the child seat system manual, the head restraint of the respective seating position shall be readjusted or entirely removed.

After selecting a proper child seat for your child, check to make sure it fits properly in your vehicle. Follow the instructions provided by the manufacturer when installing the child seat. Note these general steps when installing the seat to your vehicle:

- **Properly secure the child restraint to the vehicle.** All child restraints must be secured to the vehicle with the lap part of a lap/shoulder belt or with the LATCH system.
- **Make sure the child restraint is firmly secured.** After installing a child restraint to the vehicle, push and pull the seat forward-and-back and side-to-side to verify that it is securely attached to the seat. A child restraint secured with a seat belt should be installed as firmly as possible. However, some side-to-side movement can be expected.
- **Secure the child in the child restraint.** Make sure the child is properly strapped in the child restraint according to the manufacturer instructions.



#### **CAUTION**

**A child restraint in a closed vehicle can become very hot. To prevent burns, check the seating surface and buckles before placing your child in the child restraint.**

#### ***Lower Anchors and Tether for Children (LATCH System)***

The LATCH system holds a child restraint during driving and in an accident. This system is designed to make installation of the child restraint easier and reduce the possibility of improperly installing your child restraint. The LATCH system uses anchors in the vehicle and attachments on the child restraint. The LATCH system eliminates the need to use seat belts to secure the child restraint to the rear seats.

Lower anchors are metal bars built into the vehicle. There are two lower anchors for each LATCH seating position that will accommodate a child restraint with lower attachments.

To use the LATCH system in your vehicle, you must have a child restraint with LATCH attachments.

The child seat manufacturer will provide you with instructions on how to use the child seat with its attachments for the LATCH lower anchors.

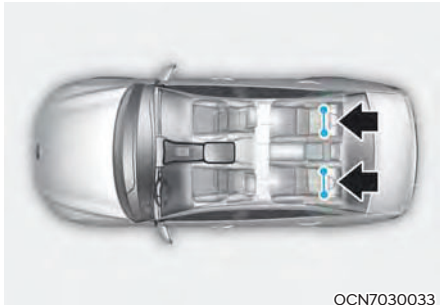

LATCH anchors have been provided in the left and right outboard rear seating positions. Their locations are shown in the illustration. There are no LATCH anchors provided for the center rear seating position.

 **WARNING**

**Do not attempt to install a child restraint system using LATCH anchors in the rear center seating position. There are no LATCH anchors provided for this seat. Using the outboard seat anchors can damage the anchors which may break or fail in a collision resulting in serious injury or death.**

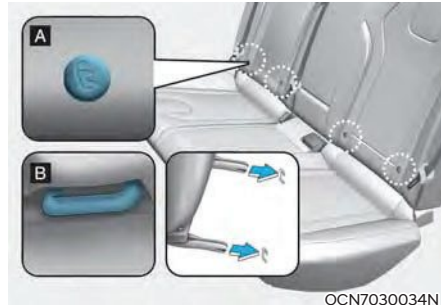

[A]: Lower Anchor Position Indicator  
[B]: Lower Anchor

The lower anchor position indicator symbols are located on the left and right rear seat backs to identify the position of the lower anchors in your vehicle (see arrows in illustration).

The LATCH anchors are located between the seatback and the seat cushion of the rear seat left and right outboard seating positions.

***Securing a child restraint with the LATCH anchors system***

To install a LATCH-compatible child restraint in either of the rear outboard seating positions:

1. Move the seat belt buckle away from the lower anchors.
2. Move any other objects away from the anchors that could prevent a secure connection between the child restraint and the lower anchors.
3. Place the child restraint on the vehicle seat, then attach the seat to the lower anchors according to the instructions provided by the child restraint manufacturer.
4. Follow the child restraint instructions for properly adjusting and tightening the lower attachments on the child restraint to the lower anchors.

**⚠ WARNING**

Take the following precautions when using the LATCH system:

- Read and follow all installation instructions provided with your child restraint system.
- To prevent the child from reaching and taking hold of unretracted seat belts, buckle all unused rear seat belts and retract the seat belt webbing behind the child. Children can be strangled if a shoulder belt becomes wrapped around their neck and the seat belt tightens.
- **NEVER** attach more than one child restraint to a single anchor. This could cause the anchor or attachment to come loose or break.
- Always have the LATCH system inspected by your authorized HYUNDAI dealer after an accident. An accident can damage the LATCH system and may not properly secure the child restraint.

**NOTICE**

The recommended weight for the LATCH system is under 65 lb (30 kg).

How to determine an appropriate child restraint weight:

Child weight + Child restraint weight < 65 lb (30kg)

**Securing a child restraint seat with "Tether Anchor" system**

First secure the child restraint with the LATCH lower anchors or the seat belt. If the child restraint manufacturer recommends that the top tether strap be attached, attach and tighten the top tether strap to the top tether strap anchor.

Child restraint hook holders are located on the rear of the seatbacks.

**⚠ WARNING**

Take the following precautions when installing the tether strap:

- Read and follow all installation instructions provided with your child restraint system.
- **NEVER** attach more than one child restraint to a single tether anchor. This could cause the anchor or attachment to come loose or break.
- Do not attach the tether strap to anything other than the correct tether anchor. It may not work properly if attached to something else.
- Do not use the tether anchors for adult seat belts or harnesses, or for attaching other items or equipment to the vehicle.



To install the tether anchor:

1. Route the child restraint tether strap over the child restraint seatback. Route the tether strap under the head restraint and between the head restraint posts, or route the tether strap over the top of the vehicle seatback. Make sure the strap is not twisted.
2. Connect the tether strap hook to the tether anchor, then tighten the tether strap according to the child seat manufacturer's instructions to firmly secure the child restraint to the seat.
3. Check that the child restraint is securely attached to the seat by pushing and pulling the seat forward-and-back and side-to-side.

#### ***Securing a child restraint with lap/shoulder belt***

When not using the LATCH system, all child restraints must be secured to a vehicle rear seat with the lap part of a lap/shoulder belt.



#### **WARNING**

**ALWAYS** place a rear-facing child restraint in the rear seat of the vehicle.

**Placing a rear-facing child restraint in the front seat can result in serious injury or death if the child restraint is struck by an inflating air bag.**

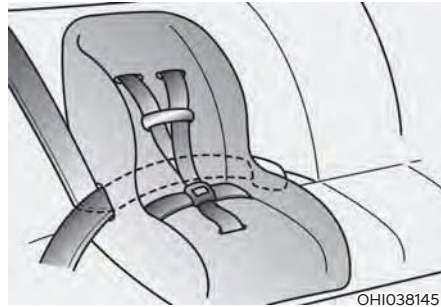

#### **Automatic locking mode**

Since all passenger seat belts move freely under normal conditions and only lock under extreme or emergency conditions (emergency locking mode), you must manually pull the seat belt all the way out to shift the retractor to the "Automatic Locking" mode to secure a child restraint.

The "Automatic Locking" mode will help prevent the normal movement of the child in the vehicle from causing the seat belt to loosen and compromise the child restraint system. To secure a child restraint system, use the following procedure.

To install a child restraint system on the rear seats, do the following:

1. Place the child restraint system on a rear seat and route the lap/ shoulder belt around or through the child restraint, following the restraint manufacturer's instructions. Be sure the seat belt webbing is not twisted.

**i** Information

When using the rear center seat belt, you should also refer to the "Rear Seat Belt – Passenger's 3-point system" section in this chapter.

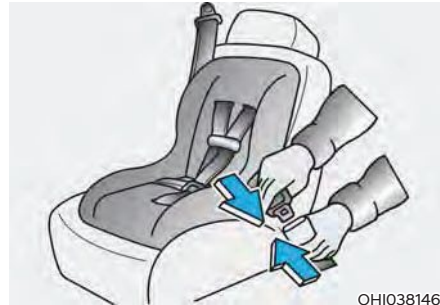

2. Fasten the lap/shoulder belt latch into the buckle. Listen for the distinct "click" sound.

**i** Information

Position the release button so that it is easy to access in case of an emergency.



3. Pull the shoulder portion of the seat belt all the way out. When the shoulder portion of the seat belt is fully extended, it will shift the retractor to the "Automatic Locking" (child restraint) mode.





4. Slowly allow the shoulder portion of the seat belt to retract and listen for an audible “clicking” or “ratcheting” sound. This indicates that the retractor is in the “Automatic Locking” mode. If no distinct sound is heard, repeat steps 3 and 4.
5. Remove as much slack from the belt as possible by pushing down on the child restraint system while feeding the shoulder belt back into the retractor.
6. Push and pull on the child restraint system to confirm that the seat belt is holding it firmly in place. If it is not, release the seat belt and repeat steps 2 through 6.
7. Double check that the retractor is in the “Automatic Locking” mode by attempting to pull more of the seat belt out of the retractor. If you cannot, the retractor is in the “Automatic Locking” mode.

If your CRS (child restraint system) manufacturer instructs or recommends you to use a tether anchor with the lap/shoulder belt, refer to the previous pages for more information.

### **i** Information

**When the seat belt is allowed to retract to its fully stowed position, the retractor will automatically switch from the “Automatic Locking” mode to the emergency lock mode for normal adult usage.**

### **!** WARNING

**If the retractor is not in the “Automatic Locking” mode, the child restraint can move when your vehicle turns or stops suddenly. A child can be seriously injured or killed if the child restraint is not properly anchored in the car, including manually pulling the seat belt all the way out to shift the retractor to the “Automatic Locking” mode.**

To remove the child restraint, press the release button on the buckle and then pull the lap/shoulder belt out of the restraint and allow the seat belt to retract fully.

## AIR BAG - ADVANCED SUPPLEMENTAL RESTRAINT SYSTEM

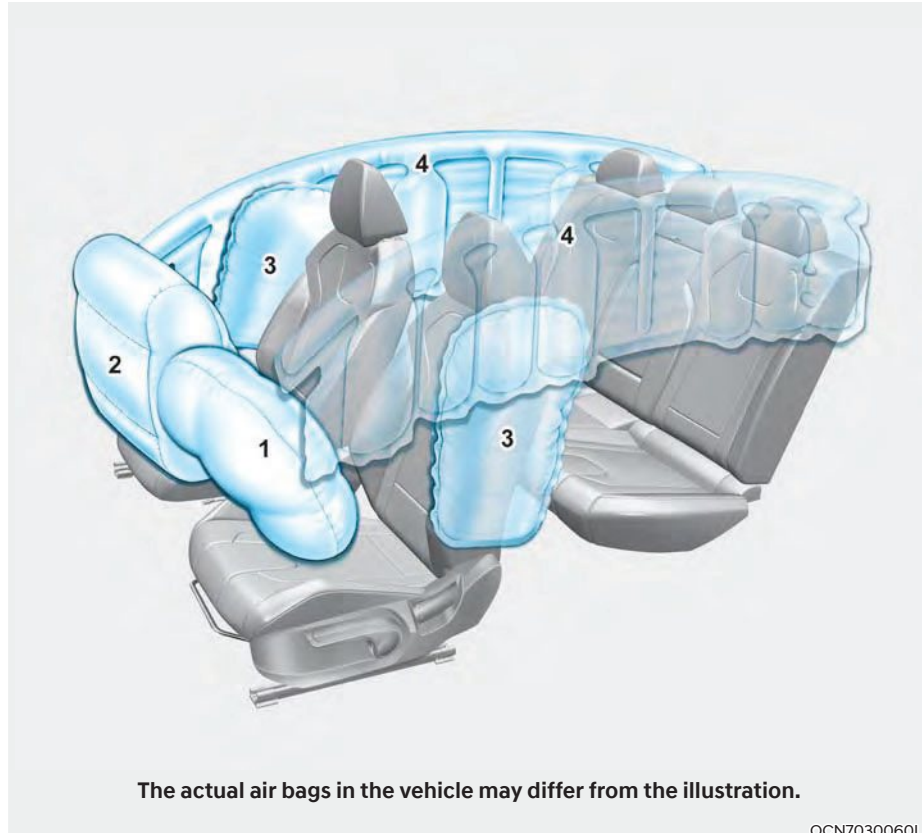

1. Driver's front air bag
2. Passenger's front air bag
3. Side air bag
4. Curtain air bag

This vehicle is equipped with an Advanced Supplemental Air Bag System for the driver's seat and front passenger's seats.

The front air bags are designed to supplement the three-point seat belts. For these air bags to provide protection, the seat belts must be worn at all times when driving.

You can be severely injured or killed in an accident if you are not wearing a seat belt. Air bags are designed to supplement seat belts, but do not replace them. Also, air bags are not designed to deploy in every collision. In some accidents, the seat belts are the only restraint protecting you.



### **WARNING**

#### **AIR BAG SAFETY PRECAUTIONS**

**ALWAYS** use seat belts and child restraints - every trip, every time, everyone! Even with air bags, you can be seriously injured or killed in a collision if you are improperly belted or not wearing your seat belt when the air bag inflates.

**NEVER** place a child in any child restraint or booster seat in the front passenger seat. An inflating air bag could forcefully strike the infant or child causing serious or fatal injuries.

**ABC - Always Buckle Children** under age 13 in the back seat. It is the safest place for children of any age to ride. If a child age 13 or older must be seated in the front seat, he or she must be properly belted and the seat should be moved as far back as possible.

All occupants should sit upright with the seatback in an upright position, centered on the seat cushion with their seat belt on, legs comfortably extended and their feet on the floor until the vehicle is parked and is turned off. If an occupant is out of position during an accident, the rapidly deploying air bag may forcefully contact the occupant causing serious or fatal injuries.

You and your passengers should never sit or lean unnecessarily close to the air bags or lean against the door or center console.

Move your seat as far back as possible from front air bags, while still maintaining control of the vehicle. The U.S. National Highway Traffic Safety Administration (NHTSA) recommends that drivers allow at least 10 inches (25 cm) between the center of the steering wheel and the chest.

### Where Are the Air Bags?

#### ***Driver's and passenger's front air bags***

Your vehicle is equipped with an Advanced Supplemental Restraint System (SRS) and lap/shoulder belts at both the driver and passenger seating positions.

The SRS consists of air bags which are located in the center of the steering wheel, in the driver's side lower crash pad below the steering wheel column and the passenger's side front panel pad above the glove box.

The air bags are labeled with the letters "AIR BAG" embossed on the pad covers.

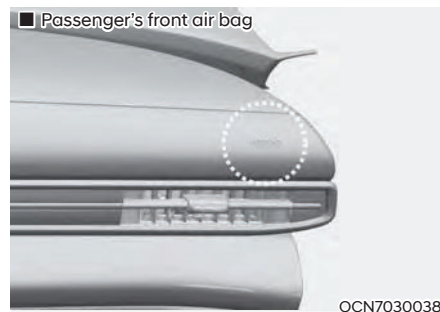

The purpose of the SRS is to provide the vehicle's driver and front passengers with additional protection than that offered by the seat belt system alone. The SRS uses sensors to gather information about the driver's and front passenger's seat belt usage and impact severity. The seat belt buckle sensors determine if the driver and front passenger's seat belts are fastened. These sensors provide the ability to control the SRS deployment based on whether or not the seat belts are fastened, and how severe the impact is. The advanced SRS offers the ability to control the air bag inflation within two levels. A first stage level is provided for moderate-severity impacts. A second stage level is provided for more severe impacts. According to the impact severity, and seat belt usage, the SRS Control Module (SRSCM) controls the air bag inflation. Failure to properly wear seat belts can increase the risk or severity of injury in an accident.



### WARNING

To reduce the risk of serious injury or death from inflating front air bags, take the following precautions:

- Seat belts must be worn at all times to help keep occupants positioned properly.
- Move your seat as far back as possible from front air bags, while still maintaining control of the vehicle.
- Never lean against the door or center console.
- Do not allow the front passenger to place their feet or legs on the dashboard.
- No objects (such as crash pad cover, cellular phone holder, cup holder, perfume or stickers) should be placed over or near the air bag modules on the steering wheel, instrument panel, windshield glass, and the front passenger's panel above the glove box. Such objects could cause harm if the vehicle is in a crash severe enough to cause the air bags to deploy.

### Side air bags

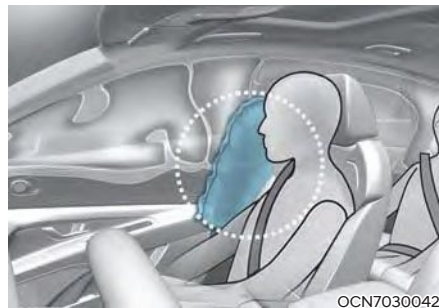

Your vehicle is equipped with a side air bag in each front seat. The purpose of the air bag is to provide the vehicle's driver and the front passenger with additional protection than that offered by the seat belt alone.

The side air bags are designed to deploy only during certain side impact collisions, depending on the crash severity. The side and curtain air bags on both sides of the vehicle may deploy if a rollover or possible rollover is detected. For vehicles equipped with a rollover sensor the side air bags and pre-tensioners on both sides of the vehicle may deploy if a rollover or possible rollover is detected. However, the side air bags are not designed to deploy in all side impact or rollover situations.



### WARNING

To reduce the risk of serious injury or death from an inflating side air bag, take the following precautions:

- Seat belts must be worn at all times to help keep occupants positioned properly.
- Do not allow passengers to lean their heads or bodies onto doors, put their arms on the doors, stretch their arms out of the window, or place objects between the doors and seats.
- Hold the steering wheel at the 9 o'clock and 3 o'clock positions, to minimize the risk of injuries to your hands and arms.
- Do not use any accessory seat covers. This could reduce or prevent the effectiveness of the system.
- Do not place any objects over the air bag or between the air bag and yourself. Also, do not attach any objects around the area the air bag inflates such as the door, side door glass, front and rear pillar.
- Do not place any objects between the door and the seat. They may become dangerous projectiles if the side air bag inflates.
- Do not install any accessories on the side or near the side air bags.
- Do not put any objects between the side airbag label and seat cushion. It could cause harm if the vehicle is in a crash severe enough to cause the air bags to deploy.
- Do not cause impact to the doors when the ignition switch button is in the ON position as this may cause the side air bags to inflate.
- If the seat or seat cover is damaged, have the vehicle checked and repaired by an authorized HYUNDAI dealer.

### Curtain air bags

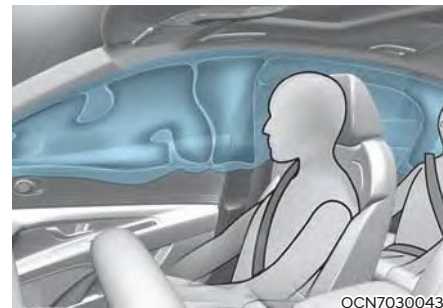

Curtain air bags are located along both sides of the roof rails above the front and rear doors.

They are designed to help protect the heads of the front seat occupants and the rear outboard seat occupants in certain side impact collisions.

The curtain air bags are designed to deploy during certain side impact collisions, depending on the crash severity.

The side and curtain air bags on both sides of the vehicle may deploy if a rollover or possible rollover is detected.

The curtain air bags are not designed to deploy in all side impact or rollover situations.



### WARNING

To reduce the risk of serious injury or death from an inflating curtain air bag, take the following precautions:

- All seat occupants must wear seat belts at all times to help keep occupants positioned properly.
- Properly secure child restraints as far away from the door as possible.
- Do not place any objects over the air bag. Also, do not attach any objects around the area the air bag inflates such as the door, side door glass, front and rear pillar, roof side rail.
- Do not hang other objects except clothes, especially hard or breakable objects. In an accident, it may cause vehicle damage or personal injury.
- Do not allow passengers to lean their heads or bodies onto doors, put their arms on the doors, stretch their arms out of the window, or place objects between the doors and seats.
- Do not open or repair the side curtain air bags.

### How Does the Air Bag System Operate?

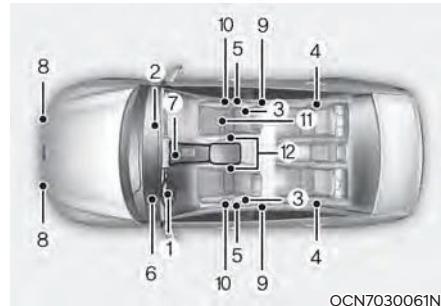

The SRS consists of the following components:

1. Driver's front air bag module
2. Passenger's front air bag module
3. Side air bag modules (front)
4. Curtain air bag modules
5. Retractor pre-tensioner assemblies
6. Air bag warning light
7. SRS control module (SRSCM) / Rollover sensor
8. Front impact sensors
9. Side impact sensors (acceleration)
10. Side impact sensors (pressure)
11. Occupant classification system
12. Driver's and front passenger's seat belt buckle sensors

The SRSCM (Supplemental Restraint System Control Module) continually monitors all SRS components while the Engine Start/Stop button is in the ON position or approximately within 3 minutes after the ignition is off to determine if a crash impact is severe enough to require air bag deployment or pre-tensioner seat belt deployment.



### SRS warning light

The SRS (Supplement Restraint System) air bag warning light on the instrument panel displays the air bag symbol depicted in the illustration. The system checks the air bag electrical system for malfunctions. The light indicates that there is a potential malfunction with your air bag system, which could include your side and curtain air bags used for rollover protection.



### WARNING

**If your SRS malfunctions, the air bag may not inflate properly during an accident increasing the risk of serious injury or death.**

**If any of the following conditions occur, your SRS is malfunctioning:**

- **The light does not turn on for approximately three to six seconds when the Engine Start/Stop button is in the ON position.**
- **The light stays on after illuminating for approximately three to six seconds.**
- **The light comes on while the vehicle is in motion.**
- **The light blinks when the engine is running.**

**Have an authorized HYUNDAI dealer inspect the SRS as soon as possible if any of these conditions occur.**

During a frontal collision, sensors will detect the vehicle's deceleration. If the rate of deceleration is high enough, the control unit will inflate the front air bags.

The front air bags help protect the driver and front passenger by responding to frontal impacts in which seat belts alone cannot provide adequate restraint. When needed, the side air bags help provide protection in the event of a side impact or rollover.

- Air bags are activated (able to inflate if necessary) when the Engine Start/ Stop button is in the ON position or approximately within 3 minutes after ignition off.
- Air bags inflate in the event of certain frontal or side collisions to help protect the occupants from serious physical injury.
- Generally, air bags are designed to inflate based upon the severity of a collision, its direction, etc. These two factors determine whether the sensors produce an electronic deployment/inflation signal.
- The front air bags will completely inflate and deflate in an instant. It is virtually impossible for you to see the air bags inflate during an accident. It is much more likely that you will simply see the deflated air bags hanging out of their storage compartments after the collision.
- In addition to inflating in certain side collisions, vehicles equipped with a rollover sensor, side and curtain air bags will inflate if the sensing system detects a rollover.  
When a rollover is detected, side and curtain air bags will remain inflated longer to help provide protection from ejection, especially when used in conjunction with the seat belts.
- To help provide protection, the air bags must inflate rapidly. The speed of air bag inflation is a consequence of extremely short time in which to inflate the air bag between the occupant and the vehicle structures before the occupant impacts those structures. This speed of inflation reduces the risk of serious or life-threatening injuries and is thus a necessary part of air bag design.  
However, the rapid air bag inflation can also cause injuries which can include facial abrasions, bruises and broken bones because the inflation speed also causes the air bags to expand with a great deal of force.



- There are even circumstances under which contact with the air bag can cause fatal injuries, especially if the occupant is positioned excessively close to the air bag.

You can take steps to help reduce the risk of being injured by an inflating air bag. The greatest risk is sitting too close to the air bag. An air bag needs about 10 inches (25 cm) of space to inflate. NHTSA recommends that drivers allow at least 10 inches (25 cm) between the center of the steering wheel and the chest.

### **WARNING**

To reduce the risk of serious injury or death from an inflating air bag, take the following precautions:

- **NEVER** place a child restraint in the front passenger seat.  
Always properly restrain children under age 13 in the rear seats of the vehicle.
- Adjust the front passenger's and driver's seats as far to the rear as possible while allowing you to maintain full control of the vehicle.
- Hold the steering wheel with hands at the 9 o'clock and 3 o'clock positions.
- **NEVER** place anything or anyone between the air bag and the seat occupant.
- Do not allow the front passenger to place their feet or legs on the dashboard.



When the SRSCM detects a sufficiently severe impact to the front of the vehicle, it will automatically deploy the front air bags.



Upon deployment, tear seams molded directly into the pad covers will separate under pressure from the expansion of the air bags. Further opening of the covers allows full inflation of the air bags.

A fully inflated air bag, in combination with a properly worn seat belt, slows the driver or the front passenger forward motion, reducing the risk of head and chest injury.

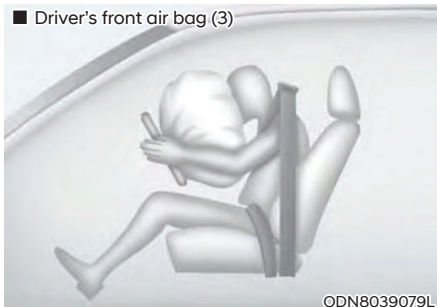

After complete inflation, the air bag immediately starts deflating, enabling the driver to maintain forward visibility and the ability to steer or operate other controls.

### **WARNING**

To prevent objects from becoming dangerous projectiles when the passenger's air bag inflates:

- Do not install or place any objects (drink holder, CD holder, stickers, etc.) on the front passenger's panel above the glove box where the passenger's air bag is located.
- Do not install a container of liquid air freshener near the instrument cluster or on the instrument panel surface.

### What to Expect After an Air Bag Inflates

After a frontal or side air bag inflates, it will deflate very quickly. Air bag inflation will not prevent the driver from seeing out of the windshield or being able to steer. Curtain air bags may remain partially inflated for some time after they deploy.

### **WARNING**

After an air bag inflates, take the following precautions:

- Open your windows and doors as soon as possible after impact to reduce prolonged exposure to the smoke and powder released by the inflating air bag.
- Do not touch the air bag storage area's internal components immediately after an air bag has inflated. The parts that come into contact with an inflating air bag may be very hot.
- Always wash exposed skin areas thoroughly with cold water and mild soap.
- Always have an authorized HYUNDAI dealer replace the air bag immediately after deployment. Air bags are designed to be used only once.

### **Noise and smoke from inflating air bag**

When the air bags inflate, they make a loud noise and may produce smoke and powder in the air inside of the vehicle. This is normal and is a result of the ignition of the air bag inflator. After the air bag inflates, you may feel substantial discomfort in breathing because of the contact of your chest with both the seat belt and the air bag, as well as from breathing the smoke and powder. The powder may aggravate asthma for some people. If you experience breathing problems after an air bag deployment, seek medical attention immediately.

Though the smoke and powder are nontoxic, they may cause irritation to the skin, eyes, nose, throat, etc. If this is the case, wash and rinse with cold water immediately and seek medical attention if the symptoms persist.

### **Occupant Classification System (OCS)**



Your vehicle is equipped with an Occupant Classification System (OCS) in the front passenger's seat.

#### **Main components of the Occupant Classification System**

- A detection device located within the front passenger seat cushion.
- Electronic system to determine whether the passenger air bag systems should be activated or deactivated.
- An indicator light located on the instrument panel which illuminates the words "PASSENGER AIR BAG OFF" indicating the front passenger air bag system is deactivated.
- The instrument panel air bag indicator light is interconnected with the OCS.

The OCS is designed to help detect the presence of a properly-seated front passenger and determine if the passenger's front air bag should be enabled (may inflate) or not.

The purpose is to help reduce the risk of injury or death from an inflating air bag to certain front passenger seat occupants, such as children, by requiring the air bag to be automatically turned OFF.

For example, if a child restraint of the type specified in the regulations is on the seat, the occupant classification sensor can detect it and cause the air bag to turn OFF.

Front passenger seat adult occupants who are properly seated and wearing the seat belt properly, should not cause the passenger air bag to be automatically turned OFF. For small adults it may be turned OFF, however, if the occupant does not sit in the seat properly (for example, by not sitting upright, by sitting on the edge of the seat, or by otherwise being out of position), this could cause the sensor to turn the air bag OFF.

You will find the "PASSENGER AIR BAG OFF" indicator on the overhead console. This system detects the conditions 1-4 in the following table and activates or deactivates the front passenger air bag based on these conditions.

Always be sure that you and all vehicle occupants are seated properly and wearing the seat belt properly for the most effective protection by the air bag and the seat belt.

Never install a Child Restraint System in the front passenger's seat. If you should install a CRS (Child Restraint System) inevitably, use a forward-facing CRS with 3-point ALR safety seat belt and adjust the front passenger's seat as far to the rear as possible. If the PASSENGER AIR BAG "OFF" indicator is OFF after a CRS (Child Restraint System) is equipped, the front passenger's airbag is operating so you should install the CRS in the rear seats of the vehicle immediately.

The OCS may not function properly if the passenger takes actions which can affect the classification system. These include:

- Failing to sit in an upright position.
- Leaning against the door or center console.
- Sitting towards the sides of the front of the seat.
- Putting their legs on the dashboard or resting them on other locations which reduce the passenger weight on the front seat.
- Wearing the seat belt improperly.
- Reclining the seatback.
- Wearing a thick cloth like ski wear or hip protection wear.
- Putting an additional thick cushion on the seat.
- Putting electrical devices (e.g. notebook, satellite radio) on the seat with inverter charging.

**Condition and operation in the front passenger Occupant Classification System**

Condition detected by the occupant classification system	Indicator/Warning light		Devices
	“PASSENGER AIR BAG OFF” indicator light	SRS warning light	Front passenger air bag
1. Adult *1	Off	Off	Activated
2. Infant *2 or child restraint system with 12 months old *3 *4	On	Off	Deactivated
3. Unoccupied	On	Off	Deactivated
4. Malfunction in the system	Off	On	Activated

\*1: The system judges a person of adult size as an adult. When a smaller adult sits in the front passenger seat, the system may recognize him/her as a child depending on his/her physique and posture.

\*2: Do not allow children to ride in the front passenger seat. When a larger child who has outgrown a child restraint system sits in the front passenger seat, the system may recognize him/her as an adult depending upon his/her physique or sitting position.

\*3: Never install a child restraint system on the front passenger seat.

\*4: The PASSENGER AIR BAG “OFF” indicator may turn on or off when a child above 12 months to 12 years old (with or without child restraint system) sits in the front passenger seat. This is a normal condition.

 **WARNING**

Riding in an improper position or placing weight on the front passenger's seat when it is unoccupied by a passenger adversely affects the OCS. To reduce the risk of serious injury or death:



OVQ036013NB

- **NEVER** put a heavy load in the front seat or seatback pocket, or hang any items on the front passenger seat.



OLMB033100

- **NEVER** place your feet on the front passenger seatback.



OLMB033101

- **NEVER** sit with your hips shifted towards the front of the seat.



OLMB033103

- **NEVER** ride with the seatback reclined when the vehicle is moving.



OLMB033102

- **NEVER** place your feet or legs on the dashboard.



- **NEVER** lean on the door or center console or sit on one side of the front passenger seat.



- Do not sit on the passenger seat wearing heavily padded clothes such as ski wear and hip protector.



- Do not use car seat accessories such as thick blankets and cushions which cover up the car seat surface.



- Do not place electronic devices such as laptops, DVD player, or conductive materials such as water bottles on the passenger seat.
- Do not use electronic devices such as laptops and satellite radios which use inverter chargers.



- If large amount of liquid has been spilled on the passenger seat, the air bag warning light may illuminate or malfunction.  
Therefore, make sure the seat has been completely dried before driving the vehicle.

- Do not place sharp objects on the front passenger seat. These may damage the occupant detection system, if they puncture the seat cushion.
- Do not place any items under the front passenger seat.
- When changing or replacing the seat or seat cover, use original items only. The OCS has been developed based on using original HYUNDAI car seats only. Altering or changing the authentic parts may result in system malfunction and increase risk of injury when in collision. Any of the above could interfere with the proper operation of the OCS sensor thereby increasing the risk of an injury in an accident.



#### Proper seated position for OCS

If the "PASSENGER AIR BAG OFF" indicator is on when an adult is seated in the front passenger seat, place the Engine Start/Stop button in the OFF position and ask the passenger to sit properly (sitting upright with the seat back in an upright position, centered on the seat cushion with their seat belt on, legs comfortably extended and their feet on the floor). Restart the engine and have the person remain in that position. This will allow the system to detect the person and to enable the passenger air bag. If the "PASSENGER AIR BAG OFF" indicator is still on, ask the passenger to move to the rear seat.



#### WARNING

**NEVER** allow an adult passenger to ride in the front passenger seat when the "PASSENGER AIR BAG OFF" indicator is illuminated. During a collision, the air bag will not inflate if the indicator is illuminated. Have your passenger reposition themselves in the seat. If the "PASSENGER AIR BAG OFF" indicator remains illuminated after the passenger repositions themselves properly and the vehicle is restarted, have the passenger move to the rear seat because the air bag will not inflate.

#### NOTICE

The "PASSENGER AIR BAG OFF" indicator generally illuminates for approximately 4 seconds after the Engine Start/Stop button is in the ON position or after the engine is started. However, if the ignition switch or Engine Start/Stop button is turned to the ON position within 3 minutes after ignition OFF, the indicator does not illuminate. If the front passenger seat is occupied, the OCS will then classify the front passenger after several more seconds.



### **Do Not Install a Child Restraint in the Front Passenger's Seat**



Even though your vehicle is equipped with the OCS, never install a child restraint in the front passenger's seat. An inflating air bag can forcefully strike a child or child restraint resulting in serious or fatal injury.

#### **⚠ WARNING**

- **NEVER** place a rear-facing or front-facing child restraint in the front passenger's seat of the vehicle.
- An inflating frontal air bag could forcefully strike a child resulting in serious injury or death.
- Always properly restrain children in an appropriate child restraint in the rear seat of the vehicle.

### **Why Didn't My Air Bag Go Off in a Collision?**

Air bags are not designed to inflate in every collision. There are certain types of accidents in which the air bag would not be expected to provide additional protection. These include rear impacts, second or third collisions in multiple impact accidents, as well as low speed impacts. Damage to the vehicle indicates a collision energy absorption, and is not an indicator of whether or not an air bag should have inflated.

#### **⚠ WARNING**

**To reduce the risk of an air bag deploying unexpectedly and causing serious injury or death:**

- Do not hit or allow any objects to impact the locations where air bags or sensors are installed.
- Do not perform maintenance on or around the air bag sensors. If the location or angle of the sensors is altered, the air bags may deploy when they should not or may not deploy when they should.
- Do not install bumper guards or replace the bumper with a non-genuine HYUNDAI parts. This may adversely affect the collision and air bag deployment performance.
- Place the ignition switch in the LOCK/OFF or ACC position when the vehicle is being towed to prevent inadvertent air bag deployment.
- Have all air bag repairs conducted by an authorized HYUNDAI dealer.

### Air bag collision sensors



OCN7030045/OCN7030046/OCN7030047/OCN7030048/OCN7030062

1. SRS control module/Rollover sensor
2. Front impact sensors
3. Side impact sensors (acceleration)
4. Side impact sensors (pressure)

### Air bag inflation conditions



#### Front air bags

Front air bags are designed to inflate in a frontal collision depending on the severity of impact of the front collision.

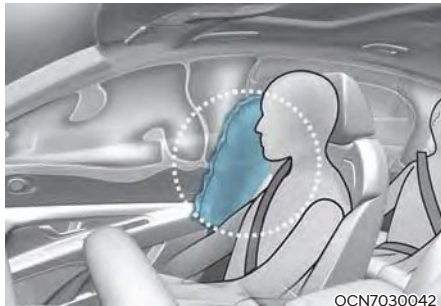

### Side and curtain air bags

Side and curtain air bags are designed to inflate when an impact is detected by side collision sensors depending on the severity of impact resulting from a side impact collision.

Although the driver's and front passenger's air bags are designed to inflate only in frontal collisions, they also may inflate in other types of collisions if the front impact sensors detect a sufficient impact. Side and curtain air bags are designed to inflate only in side impact collisions or rollover situations, but they may inflate in other collisions if the side impact sensors detect a sufficient impact.

If the vehicle chassis is impacted by bumps or objects on unimproved roads, the air bags may deploy. Drive carefully on unimproved roads or on surfaces not designed for vehicle traffic to prevent unintended air bag deployment.

### Air bag non-inflation conditions



In certain low-speed collisions the air bags may not deploy. The air bags are designed not to deploy in such cases because they may not provide benefits beyond the protection of the seat belts.



Front air bags are not designed to inflate in rear collisions, because occupants are moved backward by the force of the impact. In this case, inflated air bags would not provide any additional benefit.



In an angled collision, the force of impact may direct the occupants in a direction where the air bags would not be able to provide any additional benefit, and thus the sensors may not deploy any air bags.



Front air bags may not inflate in side impact collisions, because occupants move in the direction of the collision, and thus in side impacts, front air bag deployment would not provide additional occupant protection.

However, side and curtain air bags may inflate depending on the severity of impact.

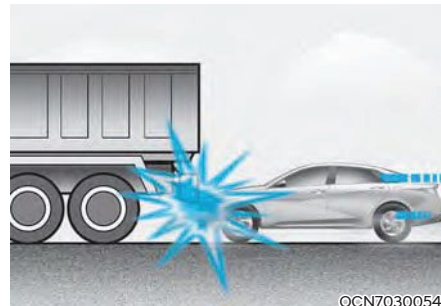

Just before impact, drivers often brake heavily. Such heavy braking lowers the front portion of the vehicle causing it to "ride" under a vehicle with a higher ground clearance. Air bags may not inflate in this "underride" situation because deceleration forces that are detected by sensors may be significantly reduced by such "underride" collisions.

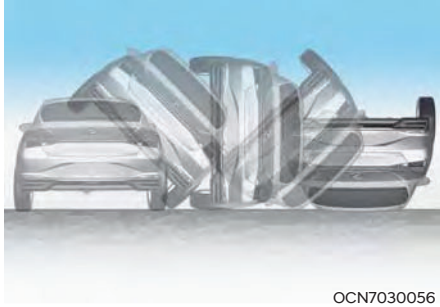

Front air bags may not inflate in rollover accidents because air bag deployment may not provide protection to the occupants.

However, side and curtain air bags may inflate when the vehicle is rolled over by a side impact collision.

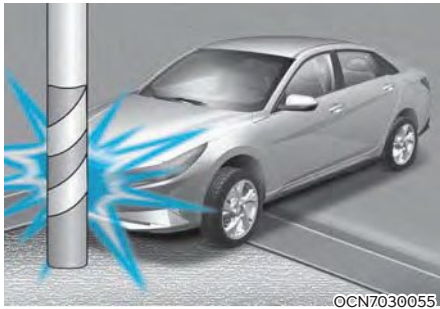

Air bags may not inflate if the vehicle collides with objects such as utility poles or trees, where the point of impact is concentrated and the collision energy is absorbed by the vehicle structure.

### SRS Care

The SRS is virtually maintenance-free and there are no parts you can safely service by yourself. If the SRS air bag warning light does not illuminate when the ignition switch is in the ON position, or continuously remains on, have your vehicle immediately inspected by an authorized HYUNDAI dealer.

Any work on the SRS system, such as removing, installing, repairing, or any work on the steering wheel, the front passenger's panel, front seats and roof rails must be performed by an authorized HYUNDAI dealer. Improper handling of the SRS system may result in serious personal injury.



### WARNING

To reduce the risk of serious injury or death, take the following precautions:

- Do not attempt to modify or disconnect the SRS components or wiring, including the addition of any kind of badges to the pad covers or modifications to the body structure.
- Do not place objects over or near the air bag modules on the steering wheel, instrument panel, or the front passenger's panel above the glove box.
- Clean the air bag pad covers with a soft cloth moistened with plain water. Solvents or cleaners could adversely affect the air bag covers and proper deployment of the system.
- Always have inflated air bags replaced by an authorized HYUNDAI dealer.
- If components of the air bag system must be discarded, or if the vehicle must be scrapped, certain safety precautions must be observed. Consult an authorized HYUNDAI dealer for the necessary information. Failure to follow these precautions could increase the risk of personal injury.

### Additional Safety Precautions

**Passengers should not move out of or change seats while the vehicle is moving.** A passenger who is not wearing a seat belt during a crash or emergency stop can be thrown against the inside of the vehicle, against other occupants, or be ejected from the vehicle.

**Do not use any accessories on seat belts.** Devices claiming to improve occupant comfort or reposition the seat belt can reduce the protection provided by the seat belt and increase the chance of serious injury in a crash.

**Do not modify the front seats.** Modification of the front seats could interfere with the operation of the supplemental restraint system sensing components or side air bags.

**Do not place items under the front seats.** Placing items under the front seats could interfere with the operation of the supplemental restraint system sensing components and wiring harnesses.

**Do not cause impact to the doors.** Impact to the doors when the Engine Start/Stop button is in the ON position may cause the air bags to inflate.

**Modifications to accommodate disabilities.** If you require modification to your vehicle to accommodate a disability, contact the HYUNDAI Customer Connect Center at 800-633-5151.

### ***Adding equipment to or modifying your air bag equipped vehicle***

If you modify your vehicle by changing your vehicle's frame, bumper system, front end or side sheet metal or ride height, this may affect the operation of your vehicle's air bag system.

### Air Bag Warning Labels

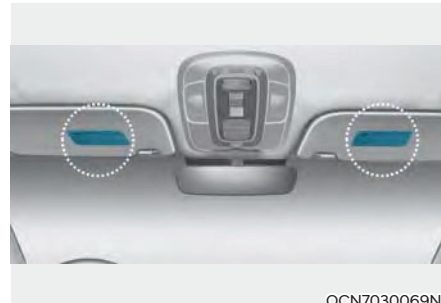

Air bag warning labels, required by the U.S. National Highway Traffic Safety Administration (NHTSA), are attached to alert the driver and passengers of potential risks of the air bag system. Be sure to read all of the information about the air bags that are installed on your vehicle in this Owners Manual.

# 4. Instrument Cluster

- Instrument Cluster ..... 4-4
- Instrument Cluster Control..... 4-5
  - Adjusting instrument cluster illumination..... 4-5
- Gauges and Meters ..... 4-5
  - Speedometer ..... 4-5
  - Tachometer ..... 4-5
  - Engine coolant temperature gauge..... 4-6
  - Fuel gauge..... 4-6
  - Outside temperature gauge..... 4-7
  - Odometer ..... 4-8
  - Range..... 4-8
- Transmission shift indicator..... 4-9
  - Manual transmission shift indicator ..... 4-9
  - Intelligent variable transmission shift indicator ..... 4-9
- Warning and Indicator Lights ..... 4-10
  - Air Bag Warning Light..... 4-10
  - Seat Belt Warning Light..... 4-10
  - Parking Brake & Brake Fluid Warning Light..... 4-10
  - Anti-lock Brake System (ABS) Warning Light..... 4-11
  - Electronic Brake Force Distribution (EBD) System Warning Light ..... 4-11
  - Electronic Parking Brake (EPB) Warning Light..... 4-12
  - AUTO HOLD Indicator Light ..... 4-12
  - Electric Power Steering (EPS) Warning Light..... 4-12
  - Malfunction Indicator Lamp (MIL)..... 4-13
  - Charging System Warning Light ..... 4-13
  - Engine Oil Pressure Warning Light ..... 4-13
  - Low Fuel Level Warning Light ..... 4-14
  - Master Warning Light ..... 4-14
  - Low Tire Pressure Warning Light ..... 4-14
  - Electronic Stability Control (ESC) Indicator Light ..... 4-15
  - Electronic Stability Control (ESC) OFF Indicator Light..... 4-15
  - AUTO STOP indicator light ..... 4-15
  - Immobilizer Indicator Light..... 4-16
  - Immobilizer Indicator Light (with smart key) ..... 4-16
  - Turn Signal Indicator Light ..... 4-17
  - Exterior Light Warning Light ..... 4-17
  - LED headlight warning light..... 4-17
  - High Beam Indicator Light ..... 4-17
  - Light ON Indicator Light ..... 4-17
  - High Beam Assist indicator light..... 4-18
  - Forward Collision-Avoidance Assist Warning Light..... 4-18
  - Lane Keep Assist Indicator Light..... 4-18

---

Cruise Indicator Light .....	4-18
SPORT Mode Indicator Light.....	4-18
SMART Mode Indicator Light.....	4-19
Icy Road Warning Light .....	4-19
LCD Display Messages.....	4-19
Shift to P or N to start engine (for smart key system) .....	4-19
Shift to P (for smart key system and intelligent variable transmission) .....	4-19
Low key battery (for smart key system).....	4-19
Press brake pedal to start engine (for smart key system and intelligent variable transmission).....	4-19
Press clutch pedal to start engine (for smart key system and manual transmission).....	4-20
Key not in vehicle (for smart key system).....	4-20
Key not detected (for smart key system).....	4-20
Press START button again (for smart key system) .....	4-20
Battery discharging due to external electrical devices.....	4-20
Press START button with key (for smart key system) .....	4-20
Check BRAKE SWITCH fuse (for smart key system and automatic transmission/intelligent variable transmission).....	4-20
Door, Hood, Trunk Open Indicator.....	4-21
Sunroof Open .....	4-21
Low Pressure .....	4-21
Lights Mode.....	4-21
Wiper .....	4-22
Heated Steering Wheel turned off.....	4-22
Low washer fluid .....	4-22
Low fuel .....	4-22
Engine Overheated .....	4-22
Check headlight .....	4-22
Check headlight (Low) .....	4-23
Check turn signal .....	4-23
Check brake light.....	4-23
Check daytime running light.....	4-23
Check high mounted stop lamp .....	4-23
Check headlight LED .....	4-23
Check Forward Collision-Avoidance Assist system.....	4-24
Check Lane Keeping Assist system .....	4-24
Check Blind-Spot Collision Warning system.....	4-24
Check Driver Attention Warning system .....	4-24
Check High Beam Assist system.....	4-24
Check Smart Cruise Control system.....	4-24



# 4. Instrument Cluster

---

LCD Display (Type A).....	4-25
LCD Display Control .....	4-25
LCD display modes.....	4-26
Trip computer mode.....	4-27
Turn By Turn (TBT) mode .....	4-27
Driving Assist mode.....	4-27
Master warning mode .....	4-28
User settings mode .....	4-29
Trip Computer.....	4-36
Trip modes.....	4-36
Average fuel economy/Instant fuel economy .....	4-36
Accumulated Info display.....	4-37
Drive Info display .....	4-38
Digital speedometer.....	4-38
Auto Stop accumulated time .....	4-38
Smart shift.....	4-39
LCD Display (Type B).....	4-40
LCD Display Control .....	4-40
View modes .....	4-41
Utility group .....	4-42
Utility Items .....	4-42
Driving Assist group.....	4-43
Navigation group .....	4-43
Driving info. group.....	4-43
Warning message group .....	4-44
User settings mode .....	4-44

## INSTRUMENT CLUSTER

■ Conventional cluster (Type A)



■ Full LCD cluster (Type B)

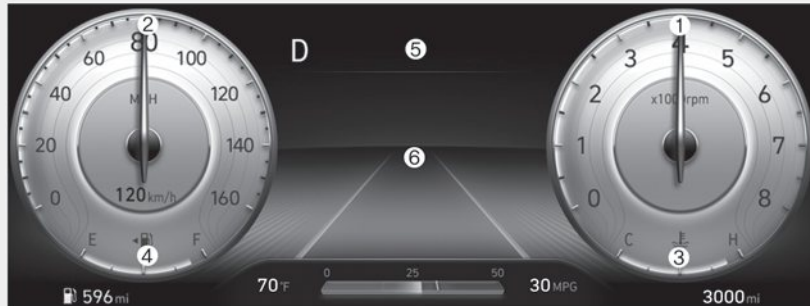

The actual cluster in the vehicle may differ from the illustration.  
For more information, refer to the "Gauges and Meters" in this chapter.

OCN7040001N/OCN7040080N

- |                                     |  |
|-------------------------------------|--|
| 1. Tachometer                       | 4. Fuel gauge                            |
| 2. Speedometer                      | 5. Warning and indicator lights          |
| 3. Engine coolant temperature gauge | 6. LCD display (including trip computer) |

## Instrument Cluster Control

### Adjusting instrument cluster illumination



When the vehicle's parking lamps or headlamps are on, press the illumination control button to adjust the brightness of the instrument panel illumination.

When pressing the illumination control button, the interior switch illumination intensity is also adjustable.

- The brightness of the instrument panel illumination is displayed.
- If the brightness reaches the maximum or minimum level, a chime will sound.



### WARNING

**Never adjust the instrument cluster while driving. Doing so could lead to driver distraction which may cause an accident and lead to vehicle damage, serious injury, or death.**

## Gauges and Meters

### Speedometer

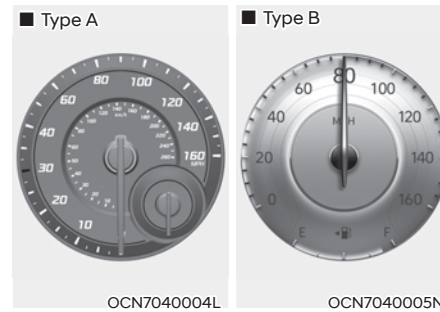

The speedometer indicates the speed of the vehicle and is calibrated in miles per hour (MPH) and/or kilometers per hour (km/h).

### Tachometer

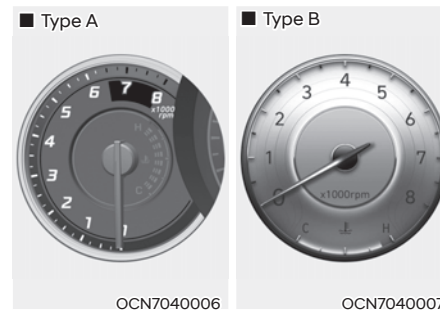

The tachometer indicates the approximate number of engine revolutions per minute (RPM).

Use the tachometer to select the correct shift points and to prevent lugging and/or over-revving the engine.

### NOTICE

**Do not operate the engine within the tachometer's RED ZONE. This may cause severe engine damage.**

### Engine coolant temperature gauge



This gauge indicates the temperature of the engine coolant when the ignition switch is in the ON position.

#### **NOTICE**

If the gauge pointer moves beyond the normal range area toward the "H" position, it indicates overheating that may damage the engine.

Do not continue driving with an overheated engine. If your engine overheats, refer to "If the Engine Overheats" in chapter 7.

#### **WARNING**

Never remove the radiator cap or reservoir cap when the engine is hot. The engine coolant is under pressure and could severely burn. Wait until the engine is cool before adding coolant to the reservoir.

### Fuel gauge



This gauge indicates the approximate amount of fuel remaining in the fuel tank.

#### **i** Information

- The fuel tank capacity is given in chapter 2.
- The fuel gauge is supplemented by a low fuel warning light, which will illuminate when the fuel tank is nearly empty.
- On inclines or curves, the fuel gauge pointer may fluctuate or the low fuel warning light may come on earlier than usual due to the movement of fuel in the tank.

**WARNING**

Running out of fuel can expose vehicle occupants to danger.

You must stop and obtain additional fuel as soon as possible after the warning light comes on or when the gauge indicator comes close to the "E (Empty)" level.

**NOTICE**

Avoid driving with an extremely low fuel level. Running out of fuel could cause the engine to misfire and damage the catalytic converter.

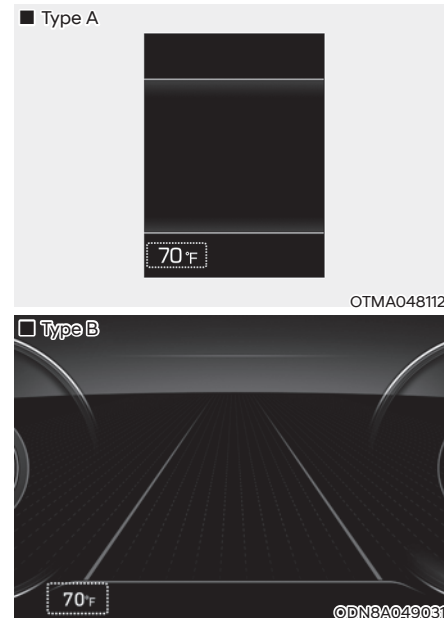
**Outside temperature gauge**

This gauge indicates the current outside air temperature by 1°F (1°C).

- Temperature range: -40°F ~ 140°F (40°C ~ 60°C)

Note that the temperature indicated on the LCD display may not change as quickly as the outside temperature (there may be a slight delay before the temperature changes.)

You can change the temperature unit from °F to °C or °C to °F in the User Settings mode in the cluster:

- Go to User Settings Mode → Other → Temperature Unit.

For vehicles equipped with Automatic Climate Control, you can also:

- Press and hold the AUTO and OFF buttons on the climate control unit for 3 seconds

Both the temperature unit on the cluster LCD display and climate control screen will change.

### Odometer

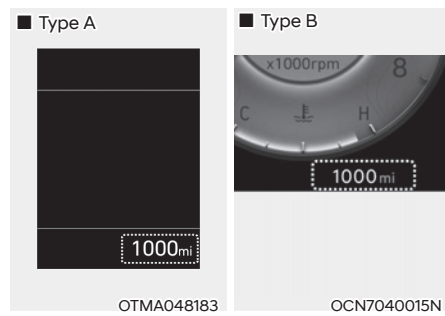

The odometer indicates the total distance that the vehicle has been driven and should be used to determine when periodic maintenance should be performed.

### Range

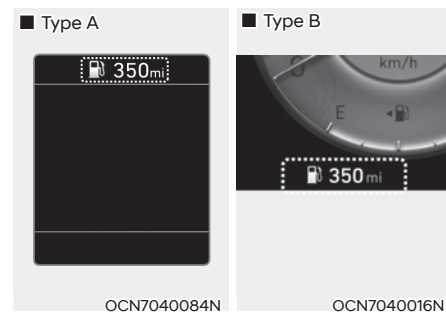

- The range is the estimated distance the vehicle can be driven with the remaining fuel.
- If the estimated distance is below 1 mi. (1 km), the trip computer will display "----" as range.

### **i** Information

- **If the vehicle is not on level ground or the battery power has been interrupted, the range function may not operate correctly.**
- **The range may differ from the actual driving distance as it is only an estimate of the available driving range for the vehicle and driving conditions.**
- **The trip computer may not register additional fuel if less than 1.6 gallon (6 liters) of fuel are added to the vehicle.**
- **The range may vary significantly based on driving conditions, driving habits, and condition of the vehicle.**

### Transmission shift indicator Manual transmission shift indicator (if equipped)



This indicator informs which gear is recommended while driving, to save fuel.

- Shifting up : ▲2, ▲3, ▲4, ▲5, ▲6
- Shifting down : ▼1, ▼2, ▼3, ▼4, ▼5

For example

▲3 : Indicates that shifting up to the 3rd gear is recommended (currently the shift lever is in the 2nd or 1st gear).

▼3 : Indicates that shifting down to the 3rd gear is recommended (currently the shift lever is in the 4th, 5th, or 6th gear).

When the system is not working properly, the indicator is not displayed.

### Intelligent variable transmission/ Dual clutch transmission shift indicator (if equipped)

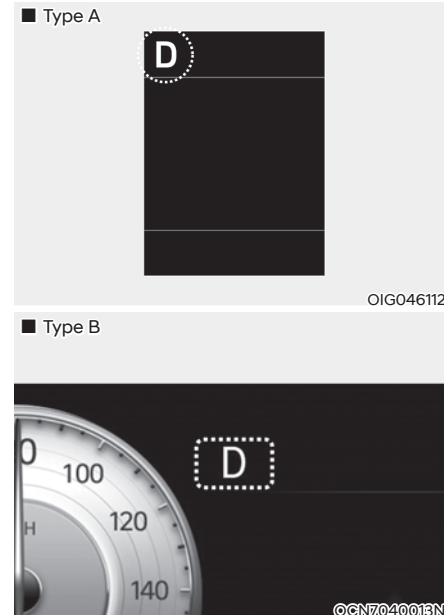

This indicator displays which shift button position is selected.

## Warning and Indicator Lights

### Information

Make sure that all warning lights are OFF after starting the engine. If any light is still ON, this indicates a situation that needs attention.

#### **Air Bag Warning Light**



This warning light illuminates:

- When you place the ignition switch to the ON position.
  - The air bag warning light illuminates for about 6 seconds and then turns off when all checks have been performed
- The air bag warning light will remain illuminated if there is a malfunction with the Safety Restraint System (SRS) air bag operation.

In this case, have the vehicle inspected by an authorized HYUNDAI dealer.

#### **Seat Belt Warning Light**



This warning light informs the driver that the seat belt is not fastened.

**For more information, refer to "Seat Belts" in chapter 3.**

#### **Parking Brake & Brake Fluid Warning Light**



This warning light illuminates:

- When you place the ignition switch to the ON position.
  - The parking brake light illuminates for about 3 seconds and will then turn off once the parking brake is released.
- Whenever the parking brake is applied.
- Whenever the brake fluid level in the reservoir is low.
  - If the warning light illuminates with the parking brake released, it indicates that the brake fluid level in the reservoir is low.

**If the brake fluid level in the reservoir is low:**

1. Drive carefully to the nearest safe location and stop your vehicle.
2. With the engine stopped, check the brake fluid level immediately and add fluid as required (**For more information, refer to "Brake Fluid" in chapter 9**). After adding brake fluid, check all brake components for fluid leaks. If a brake fluid leak is found, or if the warning light remains on, or if the brakes do not operate properly, do not drive the vehicle. Have the vehicle inspected by an authorized HYUNDAI dealer.



**Dual-diagonal braking system**

Your vehicle is equipped with dual-diagonal braking systems. This means you still have braking on two wheels even if one of the dual systems should fail.

With only one of the dual systems working, more than normal pedal travel and greater pedal pressure is required to stop the vehicle.

If the brakes fail while you are driving, shift to a lower gear for additional engine braking and stop the vehicle as soon as it is safe to do so.

**WARNING****Parking Brake & Brake Fluid Warning Light**

Driving the vehicle with a warning light ON is dangerous. If the Parking Brake & Brake Fluid Warning Light illuminates with the parking brake released, it indicates that the brake fluid level is low.

In this case, have the vehicle inspected by an authorized HYUNDAI dealer.

**Anti-lock Brake System (ABS) Warning Light**

This warning light illuminates:

- When you place the ignition switch to the ON position.
  - The ABS warning light illuminates for about 3 seconds and then turns off.
- Whenever there is a malfunction with the ABS.

Note that the hydraulic braking system will still be operational even if there is a malfunction with the ABS.

**Electronic Brake Force Distribution (EBD) System Warning Light**

These two warning lights illuminate at the same time while driving:

When the ABS and regular brake system may not work normally.

In this case, have the vehicle inspected by an authorized HYUNDAI dealer.

**WARNING****Electronic Brake Force Distribution (EBD) System Warning Light**

When both ABS and Parking Brake & Brake Fluid Warning Lights are on, the brake system will not work normally and you may experience an unexpected and dangerous situation during sudden braking.

In this case, avoid high speed driving and abrupt braking.

Have the vehicle inspected by an authorized HYUNDAI dealer as soon as possible.

**i** **Information - Electronic Brake Force Distribution (EBD) System Warning Light**

When the ABS Warning Light is on or both ABS and Parking Brake & Brake Fluid Warning Lights are on, the speedometer, odometer, or tripmeter may not work. Also, the EPS Warning Light may illuminate and the steering effort may increase or decrease.

In this case, have the vehicle inspected by an authorized HYUNDAI dealer as soon as possible.

**Electronic Parking Brake (EPB) Warning Light (if equipped)** **EPB**

This warning light illuminates:

- When you place the Engine Start/Stop button to the ON position.
  - The EPB warning light illuminates for approximately 3 seconds and then turns off.
- Whenever there is a malfunction with the EPB.

If this occurs, have the vehicle inspected by an authorized HYUNDAI dealer.

**i** **Information**

The Electronic Parking Brake (EPB) Warning Light may illuminate when the Electronic Stability control (ESC) Indicator Light comes on to indicate that the ESC is not working properly (This does not indicate malfunction of the EPB).

**AUTO HOLD Indicator Light (if equipped)** **AUTO HOLD**

This indicator light illuminates:

- [White] When you activate the auto hold system by pressing the AUTO HOLD button.
- [Green] When you stop the vehicle completely by depressing the brake pedal with the auto hold system activated.
- [Yellow] When there is a malfunction with the auto hold system.

In this case, have the vehicle inspected by an authorized HYUNDAI dealer.

For more information, refer to “Auto Hold” in chapter 6.

**Electric Power Steering (EPS) Warning Light** 

This warning light illuminates:

- When you place the ignition switch to the ON position.
  - The Electric Power Steering Warning light illuminates for about 3 seconds and then goes off.
- Whenever there is a malfunction with the EPS.

If this occurs, have the vehicle inspected by an authorized HYUNDAI dealer.

**Malfunction Indicator Lamp (MIL)**

This warning light illuminates:

- When you place the ignition switch to the ON position.
  - The malfunction indicator light illuminates for about 3 seconds and then goes off.
- Whenever there is a malfunction with either the emission control system or the engine or the vehicle powertrain.

If this occurs, have the vehicle inspected by an authorized HYUNDAI dealer.

**NOTICE**

**Driving with the Malfunction Indicator Lamp (MIL) on may cause damage to the emission control system which could affect drivability and/or fuel economy.**

**NOTICE**

**If the Malfunction Indicator Lamp (MIL) illuminates, potential catalytic converter damage is possible which could result in loss of engine power.**

**In this case, have the vehicle inspected by an authorized HYUNDAI dealer as soon as possible.**

**If the oil pressure lowers due to insufficient engine oil, etc., the engine oil pressure warning light turns on and an enhanced engine protection system that limits the engine's power is activated. After that, engine warning light turns on if driving repeatedly and continuously.**

**Charging System Warning Light**

When this warning light illuminates while the engine is running, the battery is not being charged. Immediately turn OFF all electrical accessories. Try not to use electrically operated controls, such as the power windows. Keep the engine running.

Have the vehicle inspected by an authorized HYUNDAI dealer as soon as possible.

**Engine Oil Pressure Warning Light**

This warning light illuminates:

When the engine oil pressure is low.

**If the engine oil pressure is low:**

1. Drive carefully to the nearest safe location and stop your vehicle.
2. Turn the engine off and check the engine oil level (**For more information, refer to "Engine Oil" in chapter 8**). If the level is low, add oil as required.

If the warning light remains on after adding oil or if oil is not available, have the vehicle inspected by an authorized HYUNDAI dealer as soon as possible.

**WARNING**

**When oil pressure is restored to an optimal level, the oil pressure warning light and the protection system that limits engine power will turn off. Even if the oil pressure returns to normal, check the engine once again in a safe place.**

**NOTICE**

- If the engine is not turned OFF immediately after the Engine Oil Pressure Warning Light is illuminated, severe damage could occur.
- If the warning light stays on while the engine is running, it indicates that there may be serious engine damage or malfunction. In this case:
  1. Stop the vehicle as soon as it is safe to do so.
  2. Turn off the engine and check the oil level. If the oil level is low, fill the engine oil to the proper level.
  3. Start the engine again. If the warning light stays on after the engine has started, turn the engine off immediately. In this case, have the vehicle inspected by an authorized HYUNDAI dealer.

**Low Fuel Level Warning Light**



This warning light illuminates:

When the fuel tank is nearly empty. Add fuel as soon as possible.

**NOTICE**

Driving with the Low Fuel Level warning light on or with the fuel level below "E" can cause the engine to misfire and damage the catalytic converter.

**Master Warning Light**



This indicator light illuminates:

When there is a malfunction in operation in any of the following systems:

- Forward Collision-Avoidance Assist system malfunction (if equipped)
- Forward Collision-Avoidance Assist radar blocked (if equipped)
- Blind-Spot Collision Warning system malfunction (if equipped)
- Blind-Spot Collision Warning radar blocked (if equipped)
- High Beam Assist malfunction (if equipped)
- Lamp malfunction (if equipped)
- Smart Cruise Control malfunction (if equipped)
- Tire Pressure Monitoring System (TPMS) malfunction (if equipped)

To identify the details of the warning, look at the LCD display.

**Low Tire Pressure Warning Light (if equipped)**



This warning light illuminates:

- When you place the ignition in the ON position.
  - It illuminates for approximately 3 seconds and then goes off.
- When one or more of your tires are significantly underinflated. (The location of the underinflated tires is displayed on the LCD display.)

For more information, refer to "Tire Pressure Monitoring System (TPMS)" in chapter 8.

This warning light remains ON after blinking for approximately 60 seconds, or repeatedly blinks ON and OFF in 3 second intervals:

When there is a malfunction with the TPMS.

In this case, have the vehicle inspected by an authorized HYUNDAI dealer as soon as possible.

For more information, refer to "Tire Pressure Monitoring System (TPMS)" in chapter 8.



### WARNING

#### Safe Stopping

- The TPMS cannot alert you to severe and sudden tire damage caused by external factors.
- If you notice any vehicle instability, immediately take your foot off the accelerator pedal, apply the brakes gradually with light force, and slowly move to a safe position off the road.

### Electronic Stability Control (ESC) Indicator Light



This indicator light illuminates:

- When you place the ignition switch to the ON position.
  - The Electronic Stability Control indicator light illuminates for about 3 seconds and then goes off.
- Whenever there is a malfunction with the ESC system.

If this occurs, have the vehicle inspected by an authorized HYUNDAI dealer.

This indicator light blinks:

While the ESC is operating.

For more information, refer to "Electronic Stability Control (ESC)" in chapter 6.

### Electronic Stability Control (ESC) OFF Indicator Light



This indicator light illuminates:

- When you place the ignition switch to the ON position.
  - It illuminates for approximately 3 seconds and then goes off.
- When you deactivate the ESC system by pressing the ESC OFF button.

For more information, refer to "Electronic Stability Control (ESC)" in chapter 6.

### AUTO STOP indicator light (if equipped)



This indicator light illuminates:

When the engine enters the Idle Stop mode of ISG (Idle Stop and Go) system.

When the engine automatically starts, the AUTO STOP indicator on the cluster illuminates to white.

For more details, refer to "ISG (Idle Stop and Go) system" section in chapter 6.

### Information

When the engine automatically starts by the ISG system, some warning lights (ABS, ESC, ESC OFF, EPS or Parking brake warning light) may turn on for a few seconds. This happens because of low battery voltage. It does not mean the system has malfunctioned.

### **Immobilizer Indicator Light**



**This indicator light illuminates:**

- When the vehicle detects the immobilizer in the key with the ignition switch in the ON position.
- At this time, you can start the engine.
- The indicator light goes off after starting the engine.

**This indicator light blinks:**

- When there is a malfunction with the immobilizer system.

If this occurs, have the vehicle inspected by an authorized HYUNDAI dealer.

### **Immobilizer Indicator Light (with smart key) (if equipped)**



**This indicator light illuminates for up to 30 seconds:**

When the vehicle detects the smart key in the vehicle with the Engine Start/Stop button in the ACC or ON position.

- Once the smart key is detected, you can start the engine.
- The indicator light goes off after starting the engine.

**This indicator light blinks for a few seconds:**

When the smart key is not in the vehicle.

- If the smart key is not detected, you cannot start the engine.

**This indicator light illuminates for 2 seconds and goes off:**

If the smart key is in the vehicle and the Engine Start/Stop button is ON, but the vehicle cannot detect the smart key.

In this case, have the vehicle inspected by an authorized HYUNDAI dealer.

**This indicator light blinks:**

When there is a malfunction with the immobilizer system.

In this case, have the vehicle inspected by an authorized HYUNDAI dealer.

**Turn Signal Indicator Light****This indicator light blinks:**

When you operate the turn signal indicator stalk.

If any of the following occur, there may be a malfunction with the turn signal system.

- The turn signal indicator light illuminates but does not blink
- The turn signal indicator light blinks rapidly
- The turn signal indicator light does not illuminate at all

If any of these conditions occur, have your vehicle inspected by an authorized HYUNDAI dealer.

**For more details, refer to “High Beam Assist (HBA)” in chapter 5.**

**Exterior Light Warning Light (if equipped)****This warning light illuminates:**

- When one of the exterior bulbs (headlamp, DRL, turn signal lamp, stop lamp, etc) is not operating properly. One of the bulbs may need to be replaced.

** Information**

**Make sure to replace the burned out bulb with a new one of the same wattage rating.**

**LED headlight warning light (if equipped)****This warning light illuminates:**

- When you set the Engine Start/Stop button to the ON position.
  - The LED headlight warning light illuminates for approximately 3 seconds and then goes off.
- Whenever there is a malfunction with the LED headlight.

If this occurs, we recommend that you have your vehicle inspected by an authorized HYUNDAI dealer.

**NOTICE**

**Continuous driving with the LED Headlight warning light on or blinking can reduce LED headlight life.**

**High Beam Indicator Light****This indicator light illuminates:**

- When the headlights are on and in the high beam position.
- When the turn signal lever is pulled into the Flash-to-Pass position.

**Light ON Indicator Light****This indicator light illuminates:**

When the tail lights or headlamps are on.

**High Beam Assist indicator light (if equipped)**



This indicator light illuminates:

- When the High Beam is on with the light switch in the AUTO light position.
- If your vehicle detects oncoming or preceding vehicles, High Beam Assist system will switch the high beam to low beam automatically.

**For more information, refer to "High Beam Assist (HBA)" in chapter 5.**

**Forward Collision-Avoidance Assist Warning Light (if equipped)**



This warning light illuminates:

- When you set the ignition switch or Engine Start/Stop button to the ON position.
  - It illuminates for approximately 3 seconds and then goes off.
- When there is a malfunction with FCA. In this case, have your vehicle inspected by an authorized dealer of HYUNDAI.

**For more information, refer to "Forward Collision-Avoidance Assist (FCA)" in chapter 6.**

**Lane Keep Assist Indicator Light (if equipped)**



This indicator light illuminates:

- [Green] When you activate the lane departure warning system by pressing the Lane Safety button and all of the system operating conditions are satisfied.
- [White] When function operating conditions are not satisfied or when the sensor does not detect the lane line.
- [Yellow] When there is a malfunction with Lane Keeping Assist system.

In this case, have your vehicle inspected by an authorized HYUNDAI dealer.

**For more information, refer to "Lane Keeping Assist (LKA)" in chapter 6.**

**Cruise Indicator Light**



This indicator light illuminates:

- When the cruise control system is enabled.

**For more details, refer to "Cruise Control System" in chapter 6.**

**SPORT Mode Indicator Light (if equipped)**



This indicator light illuminates:

- When you select "SPORT" mode as drive mode.

**For more details, refer to "Drive Mode Integrated Control System" in chapter 6.**



**SMART Mode Indicator Light (if equipped)**

SMART

This indicator light illuminates:

- When you select "SMART" mode as drive mode.

For more details, refer to "Drive Mode Integrated Control System" in chapter 6.

**Icy Road Warning Light (if equipped)**

This indicator light illuminates:

This warning light is to warn the driver the road may be icy.

When the temperature on the outside temperature gauge is approximately below 40°F (4°C), the Icy Road Warning Light and Outside Temperature Gauge blinks and then illuminates. Also, the warning chime sounds 1 time.

The Icy Road Warning function can be activated or deactivated from the User Settings mode in the cluster LCD display.

**i Information**

**If the icy road warning light appears while driving, you should drive more attentively and safely, refraining from over-speeding, rapid acceleration, sudden braking or sharp turning, etc.**

**LCD Display Messages****Shift to P or N to start engine (for smart key system)**

This warning message is displayed if you try to start the engine with the shift button not in the P (Park) or N (Neutral) position.

**i Information**

**You can start the engine with the shift button in the N (Neutral) position. But, for your safety, we recommend that you start the engine with the shift button in the P (Park) position.**

**Shift to P (for smart key system and intelligent variable transmission)**

This message is displayed if you try to turn off the engine without the shift button in P (Park) position.

If this occurs, the Engine Start/Stop button turns to the ACC position (If you press the Engine Start/Stop button once more, it will turn to the ON position).

**Low key battery (for smart key system)**

This warning message is displayed if the battery of the smart key is discharged while changing the Engine Start/Stop button to the OFF position.

**Press brake pedal to start engine (for smart key system and intelligent variable transmission)**

This warning message is displayed if the Engine Start/Stop button changes to the ACC position twice by pressing the button repeatedly without depressing the brake pedal.

You can start the vehicle by depressing the brake pedal and then pressing the Engine Start/Stop button.

***Press clutch pedal to start engine  
(for smart key system and manual  
transmission)***

This warning message is displayed if the Engine Start/Stop button is in the ACC position twice by pressing the button repeatedly without depressing the clutch pedal.

Depress the clutch pedal to start the engine.

***Key not in vehicle  
(for smart key system)***

This warning message is displayed if the smart key is not in the vehicle when you press the Engine Start/Stop button.

When attempting to start the vehicle, always have the smart key with you.

***Key not detected  
(for smart key system)***

This warning message is displayed if the smart key is not detected when you press the Engine Start/Stop button.

***Press START button again  
(for smart key system)***

This message is displayed if you were unable to start the vehicle when the Engine Start/Stop button was pressed.

If this occurs, attempt to start the engine by pressing the Engine Start/Stop button again.

If the warning message appears each time you press the Engine Start/Stop button, have your vehicle inspected by an authorized HYUNDAI dealer.

***Battery discharging due to external  
electrical devices (if equipped)***

This message is displayed if the battery voltage is weak due to any non-factory electrical accessories (ex. dashboard camera) while parking. Be careful that the battery is not discharged.

If the warning message appears after removing the non-factory electrical accessories, have the vehicle inspected by an authorized HYUNDAI dealer.

***Press START button with key  
(for smart key system)***

This warning message is displayed if you press the Engine Start/Stop button while the warning message "Key not detected" is displayed.

At this time, the immobilizer indicator light blinks.

***Check BRAKE SWITCH fuse (for  
smart key system and automatic  
transmission/intelligent variable  
transmission)***

This warning message is displayed if the brake switch fuse is disconnected.

You need to replace the fuse with a new one before starting the engine.

If that is not possible, you can start the engine by pressing the Engine Start/Stop button for 10 seconds in the ACC position.

**Door, Hood, Trunk Open Indicator**

This warning is displayed if any door or the hood or the liftgate is left open. The warning will indicate which door is open in the display.

**CAUTION**

Before driving the vehicle, you should confirm that the door/hood/liftgate is fully closed. Also, check there is no door/hood/liftgate open warning light or message displayed on the instrument cluster.

**Sunroof Open (if equipped)**

This warning is displayed if you turn off the engine when the sunroof is open. Close the sunroof securely before leaving your vehicle.

**Low Pressure**

This warning message is displayed if the tire pressure is low. The corresponding tire on the vehicle will be illuminated.

**For more information, refer to "Tire Pressure Monitoring System (TPMS)" in chapter 8.**

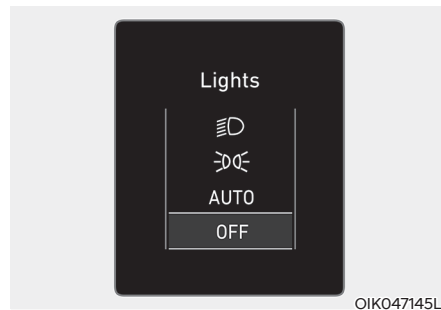
**Lights Mode**

This indicator displays which exterior light is selected using the lighting control.

### **Wiper**

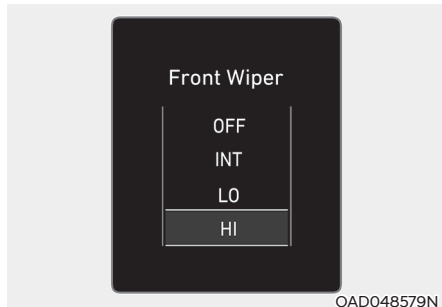

This indicator displays which wiper speed is selected using the wiper control.

### **Heated Steering Wheel turned off (if equipped)**

This message is displayed if you turn off the heated steering wheel.

**For more details, refer to “Heated Steering Wheel” in chapter 5.**

### **Low washer fluid (if equipped)**

This warning message is displayed if the washer fluid level in the reservoir is nearly empty.

Have the washer fluid reservoir refilled.

### **Low fuel**

This warning message is displayed if the fuel tank is almost out of fuel.

When this message is displayed, the low fuel level warning light in the cluster will come on.

It is recommended to look for the nearest fueling station and refuel as soon as possible.

### **Engine Overheated (if equipped)**

This warning message is displayed when the engine coolant temperature is above 248°F (120°C). This means that the engine is overheated and may be damaged.

**If your vehicle is overheated, refer to “Overheating” in chapter 8.**

### **Check headlight (if equipped)**

This warning message is displayed if the headlamps are not operating properly.

In addition, if a specific lamp (turn signal lamp etc.) is not operating properly, the warning message according to a specific lamp (turn signal lamp etc.) is displayed. A corresponding bulb may need to be replaced.

Make sure to replace the burned out bulb with a new one of the same wattage rating.

**Check headlight (Low) (if equipped)**

This warning message is displayed if the headlamp (Low) are not operating properly.

In addition, if a specific lamp (turn signal lamp etc.) is not operating properly, the warning message according to a specific lamp (turn signal lamp etc.) is displayed. A corresponding bulb may need to be replaced.

Make sure to replace the burned out bulb with a new one of the same wattage rating.

**Check turn signal (if equipped)**

This warning message is displayed if the turn signal lamps are not operating properly. A lamp may need to be replaced.

Make sure to replace the burned out bulb with a new one of the same wattage rating.

**Check brake light (if equipped)**

This warning message is displayed if the stop lamps are not operating properly. A lamp may need to be replaced.

Make sure to replace the burned out bulb with a new one of the same wattage rating.

**Check daytime running light (if equipped)**

This warning message is displayed if the daytime running lights are not operating properly. A lamp may need to be replaced.

Make sure to replace the burned out bulb with a new one of the same wattage rating.

**Check high mounted stop lamp (if equipped)**

This warning message is displayed if the high mounted stop lamp are not operating properly. A lamp may need to be replaced.

Make sure to replace the burned out bulb with a new one of the same wattage rating.

**Check headlight LED (if equipped)**

This warning message is displayed if there is a problem with the LED headlight. Have the vehicle inspected by an authorized HYUNDAI dealer.

***Check Forward Collision-Avoidance Assist system (if equipped)***

This warning message is displayed if there is a problem with Forward Collision-Avoidance Assist. Have the vehicle inspected by an authorized HYUNDAI dealer.

**For more details, refer to “Forward Collision-Avoidance Assist (FCA)” in chapter 6.**

***Check Lane Keeping Assist system (if equipped)***

This warning message is displayed if there is a problem with Lane Keeping Assist. Have the vehicle inspected by an authorized HYUNDAI dealer.

**For more details, refer to “Lane Keeping Assist (LKA)” in chapter 6.**

***Check Blind-Spot Collision Warning system (if equipped)***

This warning message is displayed if there is a problem with the Blind-Spot Collision Warning. Have the vehicle inspected by an authorized HYUNDAI dealer.

**For more details, refer to “Blind-Spot Collision Warning (BCW)” in chapter 6.**

***Check Driver Attention Warning system (if equipped)***

This warning message is displayed if there is a problem with Driver Attention Warning. Have the vehicle inspected by an authorized HYUNDAI dealer.

**For more details, refer to “Driver Attention Warning (DAW)” in chapter 6.**

***Check High Beam Assist system (if equipped)***

This warning message is displayed if there is a problem with the High Beam Assist. Have the vehicle inspected by an authorized HYUNDAI dealer.

**For more details, refer to “High Beam Assist (HBA)” in chapter 5.**

***Check Smart Cruise Control system (if equipped)***

This warning message is displayed if there is a problem with Smart Cruise Control. Have the vehicle inspected by an authorized HYUNDAI dealer.

**For more details, refer to “Smart Cruise Control (SCC)” in chapter 6.**



## LCD DISPLAY (TYPE A)

### LCD Display Control



OCN7040023L





The LCD display modes can be changed by using the control buttons.

1. : MODE button for changing modes
2. : MOVE switch for changing items
3. OK: Push the SELECT/RESET button for setting or resetting the selected item

### Information

When the infotainment system is applied, only the User's Setting mode on the infotainment system is supported but the User's Setting mode on the instrument cluster is not supported.

### LCD display modes

Modes	Symbol	Explanation
Trip Computer		This mode displays driving information such as the tripmeter, fuel economy, etc. For more details, refer to "Trip Computer" in this chapter.
Turn By Turn (TBT)		This mode displays the state of the navigation.
Driving Assist		<ul style="list-style-type: none"> <li>- Smart Cruise Control (SCC)</li> <li>- Lane Keeping Assist (LKA)</li> <li>- Lane Following Assist (LFA)</li> <li>- Driver Attention Warning (DAW)</li> </ul>
User Settings		In this mode, you can change settings of the doors, lamps, etc.
Warning		<ul style="list-style-type: none"> <li>- This mode displays warning messages related to the lamp malfunction, etc.</li> <li>- Tire pressure information</li> </ul>

**The information provided may differ depending on which functions are applicable to your vehicle.**

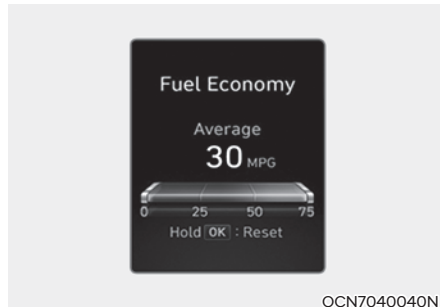

**Trip computer mode**

OCN7040040N

The trip computer mode displays information related to vehicle driving parameters including fuel economy, trip meter information and vehicle speed.

**For more information, refer to "Trip Computer" in this chapter.**

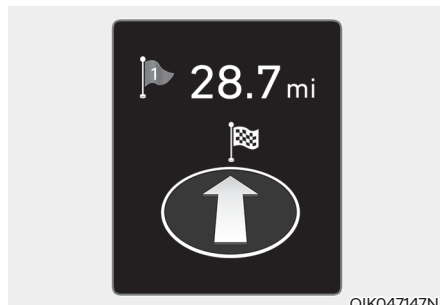
**Turn By Turn (TBT) mode**

OIK047147N

This mode displays the state of the navigation.

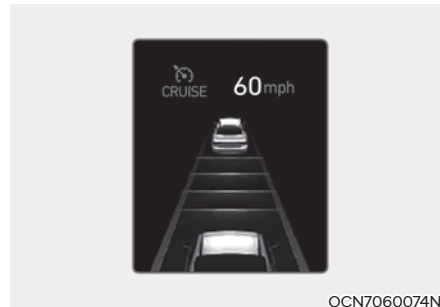
**Driving Assist mode**

OCN7060074N

**SCC/LKA**

This group displays the state of the Smart Cruise Control, Lane Keeping Assist.

**For more details, refer to each function information in chapter 7.**

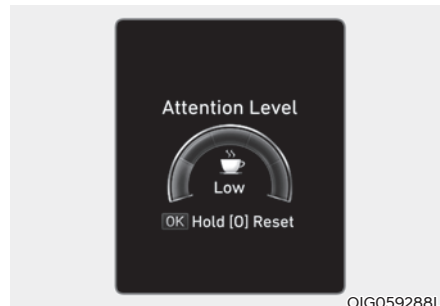

OIG059288L

**Driver Attention Warning**

This group displays information related to Driver Attention Warning.

**For more details, refer to "Driver Attention Warning (DAW)" in chapter 7.**

### Master warning mode

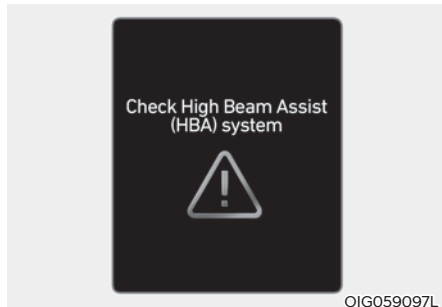

This warning light informs the driver the following situations.

- Forward Collision-Avoidance Assist system malfunction (if equipped)
- Forward Collision-Avoidance Assist radar blocked (if equipped)
- Blind-Spot Collision Warning system malfunction (if equipped)
- Blind-Spot Collision Warning radar blocked (if equipped)
- High Beam Assist malfunction (if equipped)
- Lamp malfunction (if equipped)
- Smart Cruise Control malfunction (if equipped)
- Tire Pressure Monitoring System (TPMS) malfunction (if equipped)

The Master Warning Light illuminates if one or more of the above warning situations occur. At this time, a Master Warning icon (⚠) will appear beside the User Settings icon (⚙), on the LCD display. (if equipped)

If the warning situation is solved, the master warning light will be turned off and the Master Warning icon will disappear.



### Tire Pressure

This mode displays information related to Tire Pressure.

**For more information, refer to "Tire Pressure Monitoring System (TPMS)" in chapter 8.**

## User settings mode

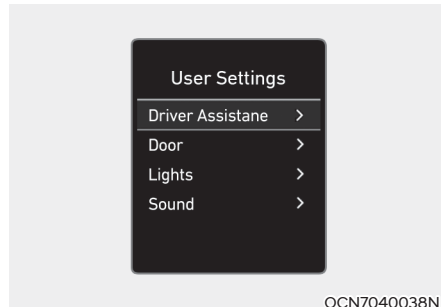

In this mode, you can change the settings of the instrument cluster, doors, lamps, etc.

1. Head-Up Display
2. Driver Assistance
3. Door
4. Lights
5. Sound
6. Convenience
7. Service interval
8. Other
9. Language
10. Reset

**The information provided may differ depending on which functions are applicable to your vehicle.**

### Shift to P to edit settings / Engage parking brake to edit settings

This warning message illuminates if you try to select an item from the User Settings mode while driving.

- Intelligent variable transmission  
For your safety, change the User Settings after parking the vehicle, applying the parking brake and moving the shift level to P(Park).
- Manual transmission  
For your safety, change the User Settings after engaging the parking brake.

### Quick guide (Help)

This mode provides quick guides for the systems in the User Settings mode.

Select an item, press and hold the OK button.

**For more details about each system, refer to this Owner's Manual.**

### 1. Driver Assistance

Items	Explanation
Driving Assist	<ul style="list-style-type: none"> <li>Highway Driving Assist: The function assists the driver to maintain the set speed, keep a safe distance with a vehicle ahead and keep the vehicle inside of the lane while driving on the highway.</li> </ul> <p><b>For more details, refer to the "Highway Driving Assist (HDA)" in chapter 7.</b></p>
Speed limit (if equipped)	<p>To adjust the Speed Limit function.</p> <ul style="list-style-type: none"> <li>Speed Limit Offset</li> <li>Auto Speed Change</li> <li>Speed Limit Assist/Speed Limit Warning/Off</li> </ul> <p><b>For more details, refer to the "Intelligent Speed Limit Assist (ISLA)" in chapter 7.</b></p>
Warning Timing	<p>To adjust the warning timing of the driver assistance system.</p> <ul style="list-style-type: none"> <li>Normal / Late</li> </ul>
Warning Volume	<p>To adjust the warning timing of the driver assistance system.</p> <ul style="list-style-type: none"> <li>High / Medium / Low / Off</li> </ul>
Driver Attention Warning	<ul style="list-style-type: none"> <li>Leading Vehicle Departure Alert</li> </ul> <p>To activate or deactivate the Leading vehicle departure alert.</p> <ul style="list-style-type: none"> <li>Inattentive Driving Warning</li> </ul> <p>To activate or deactivate the Driver Attention Warning.</p> <p><b>For more details, refer to the "Driver Attention Warning (DAW)" in chapter 7.</b></p>
Forward Safety	<p>To adjust the Lane Keeping Assist function.</p> <ul style="list-style-type: none"> <li>Active Assist/Warning Only/Off</li> </ul> <p><b>For more details, refer to the "Forward Collision-Avoidance Assist (FCA)" in chapter 7.</b></p>
Lane Safety	<p>To adjust the Lane Keeping Assist function.</p> <ul style="list-style-type: none"> <li>Lane Keeping Assist/Lane Departure Warning/Off</li> </ul> <p><b>For more details, refer to "Lane Keeping Assist (LKA)" in chapter 7.</b></p>
Blind-Spot Safety	<ul style="list-style-type: none"> <li>Safe Exit Warning (SEW)</li> </ul> <p>To activate or deactivate the Safe Exit Warning.</p> <p><b>For more details, refer to the "Safe Exit Warning (SEW)" in chapter 7.</b></p> <ul style="list-style-type: none"> <li>Active Assist/Warning Only/ Off</li> </ul> <p><b>For more details, refer to "Blind-Spot Collision Warning (BCW)" or "Blind-Spot Collision-Avoidance Assist (BCA)" in chapter 7.</b></p>

Items	Explanation
Parking Safety	<ul style="list-style-type: none"><li>• Parking Distance Warning Auto ON</li><li>• Rear Cross-Traffic Safety</li></ul> To Activate or deactivate the Rear Cross-Traffic Collision-Avoidance Assist function. <ul style="list-style-type: none"><li>• Active Assist/Warning Only/ Off</li></ul> <b>For more details, refer to “Rear Cross-Traffic Collision-Avoidance Assist (RCCA)” in chapter 7.</b>

## 2. Door

Items	Explanation
Auto Lock	<ul style="list-style-type: none"> <li>• Enable on Shift: All doors will be automatically locked if the shift lever is moved from the P (Park) position to the R (Reverse), N (Neutral), or D (Drive) position. (Only when the engine is running)</li> <li>• Enable on Speed: All doors will be automatically locked when the vehicle speed exceeds 15km/h (9.3mph).</li> <li>• Disable : The auto door lock operation will be deactivated.</li> </ul>
Auto Unlock	<ul style="list-style-type: none"> <li>• On Shift to P: All doors will be automatically unlocked if the shift lever is moved to P (Park) position. (Only when the engine is running)</li> <li>• On key out/Vehicle Off : All doors will be automatically unlocked when the ignition key is removed from the ignition switch or the Engine Start/Stop button is set to the OFF position.</li> <li>• Disable : The auto door unlock operation will be canceled.</li> </ul>
Two Press Unlock	<ul style="list-style-type: none"> <li>• Off: The two press unlock function will be deactivated. Therefore, all doors will unlock if the door unlock button is pressed.</li> <li>• On: Only the driver's door will unlock if the door unlock button is pressed. When the door unlock button is pressed again within 4 seconds, the remaining doors will unlock.</li> </ul>
Horn Feedback	To activate or deactivate the horn feedback. If the horn feedback is activated, after locking the door by pressing the lock button on the remote key, and pressing it again within 4 seconds, the horn feedback sound will operate once to indicate that all doors are locked (if equipped with remote key).
Smart Trunk	To activate or deactivate the smart trunk. <b>For more details, refer to "Smart trunk" in chapter 5.</b>

## 3. Lights

Items	Explanation
Illumination	To adjust the illumination level. - Level 1-20
One Touch Turn Signal	<ul style="list-style-type: none"> <li>• Off: The one touch turn signal function will be deactivated.</li> <li>• 3, 5, 7 Flashes: The turn signal indicator will blink 3, 5, or 7 times when the turn signal lever is moved slightly.</li> </ul> <b>For more details, refer to "Lighting" in chapter 5.</b>
Headlight Delay	<ul style="list-style-type: none"> <li>• To activate or deactivate the headlamp delay function.</li> </ul> <b>For more details, refer to "Lighting" in chapter 5.</b>
High Beam Assist	<ul style="list-style-type: none"> <li>• To activate or deactivate the High Beam Assist function.</li> </ul> <b>For more details, refer to "High Beam Assist (HBA)" in chapter 5.</b>

#### 4. Sound

Items	Explanation
Cluster Voice Guidance Volume	To adjust the cluster voice guidance volume.
Welcome sound	To activate or deactivate the welcome sound.

#### 5. Convenience

Items	Explanation
Seat Easy Access	<ul style="list-style-type: none"> <li>Off: The seat easy access function is deactivated.</li> <li>Normal/Extended: When you turn off the engine, the driver's seat will automatically move rearward short (Normal) or long (Extended) for you to enter or exit the vehicle more comfortably.</li> </ul> <p><b>For more details, refer to "Driver Position Memory System" in chapter 5.</b></p>
Rear Occupant Alert	<ul style="list-style-type: none"> <li>To activate or deactivate the rear occupant alert system.</li> </ul> <p><b>For more details, refer to the "Rear Occupant Alert (ROA)" in chapter 5.</b></p>
Welcome Light	<ul style="list-style-type: none"> <li>On door unlock: The welcome light turns on automatically when the doors are unlocked.</li> <li>On driver approach: The welcome light turns on automatically when the vehicle is approached with the smart key.</li> </ul> <p><b>For more details, refer to "Welcome System" in chapter 5.</b></p>
Wireless Charging System	To activate or deactivate the wireless charging system in the front seat. <b>For more details, refer to "Wireless cellular phone charging system" in chapter 5.</b>
Wiper/Lights Display	To activate or deactivate the Wiper/ Light mode. When activated, the LCD display shows the selected Wiper/Light mode whenever you changed the mode.
Icy Road Warning	To activate or deactivate the icy road warning function.

## 6. Service interval

Items	Explanation
Enable Service Interval	To activate or deactivate the service interval function.

### Information

To use the service interval menu, consult an authorized HYUNDAI dealer.

If the service interval is activated and the time and distance is adjusted, messages are displayed in the following situations each time the vehicle is turned on.

- Service in  
: Displayed to inform the driver the remaining mileage and days to service.
- Service required  
: Displayed when the mileage and days to service has been reached or passed.

### Information

If any of the following conditions occur, the mileage and number of days to service may be incorrect.

- The battery cable is disconnected.
- The fuse switch is turned off.
- The battery is discharged.

## 7. Theme selection

To select the style of instrument cluster graphic style and setting.

- Theme A / Theme B / Theme C



## 8. Other

Items	Explanation
Fuel Econ. Reset	<ul style="list-style-type: none"> <li>• Off: The average fuel economy will not reset automatically whenever refueling.</li> <li>• After ignition: When the engine has been OFF for 4 hours or longer the average fuel economy will reset automatically.</li> <li>• After refueling: The average fuel economy will reset automatically after adding 6 liters (1.6 gallons) of fuel or more and after driving speed exceeds 1 km/h (1 mph).</li> </ul> <p><b>For more details, refer to “Trip Computer” in this chapter.</b></p>
Speed Unit (if equipped)	To select the speed unit. (km/h, MPH)
Fuel Econ. Unit	To select the fuel economy unit. (km/L, L/100km, MPG)
Temperature Unit	To select the temperature unit. (°C, °F)
Tire Pressure Unit	To select the tire pressure unit. (psi, kPa, bar)

## 9. Language (if equipped)

Items	Explanation
Language	Choose the language. You can choose the language in infotainment system. (if equipped)

## 10. Reset

Items	Explanation
Reset	You can reset the menus in the User Settings Mode. All menus in the User Settings Mode are reset to factory settings, except language and service interval.

### Trip Computer

The trip computer is a microcomputer-controlled driver information system that displays information related to driving.

#### **i** Information

Some driving information stored in the trip computer (for example Average Vehicle Speed) resets if the battery is disconnected.

#### Trip modes

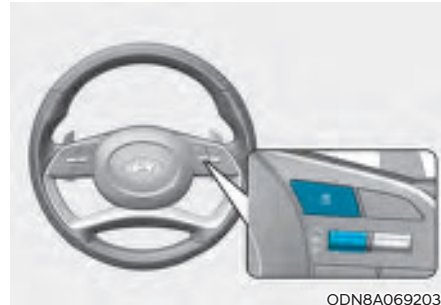
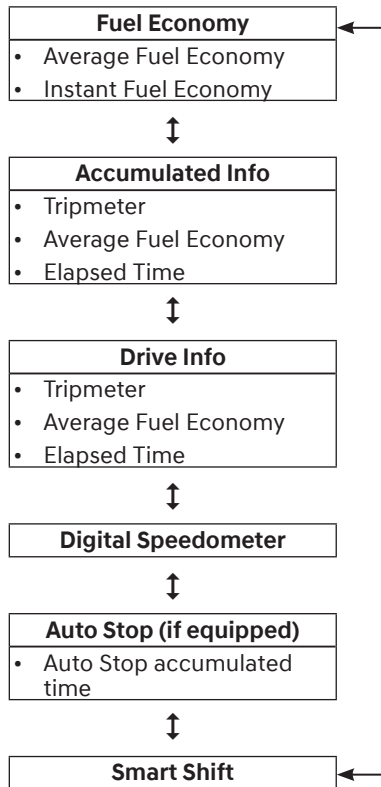

ODN8A069203

To change the trip mode, toggle the “^, v” switch on the steering wheel.

#### Average fuel economy/ Instant fuel economy

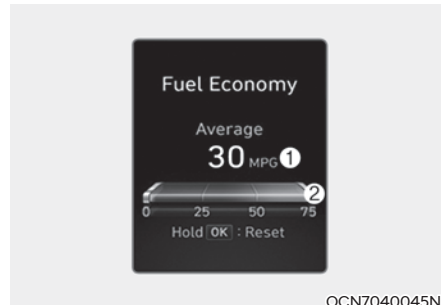

OCN7040045N

#### Average Fuel Economy (1)

- The average fuel economy is calculated by the total driving distance and fuel consumption since the last average fuel economy reset.
- The average fuel economy can be reset both manually and automatically.

**Manual reset**

To clear the average fuel economy manually, press the OK button on the steering wheel for more than 1 second when the average fuel economy is displayed.

**Automatic reset**

To automatically reset the average fuel economy after refueling, select the "Fuel Econ. Reset" mode in the User Settings menu on the LCD display.

- After Ignition: When the engine has been OFF for 4 hours or longer the average fuel economy will reset automatically.
- After Refueling: The average fuel economy will reset automatically after adding 1.6 gallons (6 liters) of fuel or more and after driving speed exceeds 1 mph (1 km/h).

***i* Information**

**The vehicle must be driven for a minimum of 0.19 miles (300 meters) since the last ignition key cycle before the average fuel economy will be recalculated.**

**Instant Fuel Economy (2)**

The instantaneous fuel economy is displayed according to the bar graph in the LCD display while driving.

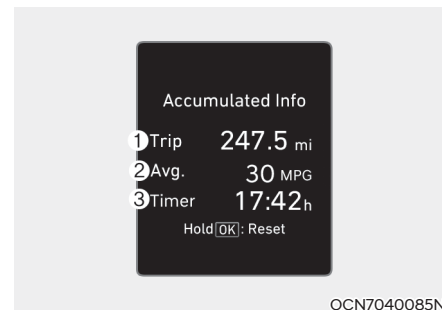
**Accumulated Info display**

This display shows the accumulated trip distance (1), the average fuel economy (2), and the total driving time (3).

The information is accumulated starting from the last reset.

To reset the information, press and hold the OK button when viewing the Accumulated driving info. The trip distance, the average fuel economy, and total driving time will reset simultaneously.

The accumulated driving information will continue to be counted while the engine is still running (EX: when the vehicle is in traffic or stopped at a stop light).

***i* Information**

**The vehicle must be driven for a minimum of 300 meters (0.19 miles) since the last ignition key cycle before the average fuel economy will be recalculated.**

### Drive Info display

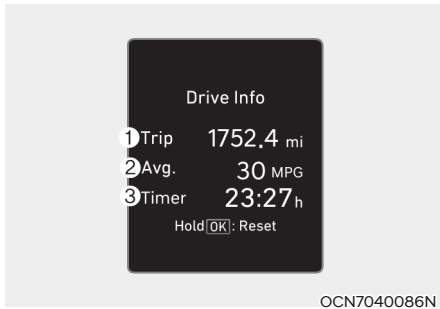

This display shows the trip distance (1), the average fuel economy (2), and the total driving time (3).

The information is combined for each ignition cycle. However, when the engine has been OFF for 4 hours or longer the Drive Info screen will reset.

To manually reset the information, press and hold the OK button when viewing the Drive Info. The trip distance, the average fuel economy, and total driving time will reset simultaneously.

The driving information will continue to be counted while the engine is still running (for example, when the vehicle is in traffic or stopped at a stop light).

### Information

**The vehicle must be driven for a minimum of 0.19 miles (300 meters) since the last ignition key cycle before the average fuel economy will be recalculated.**

### Digital speedometer

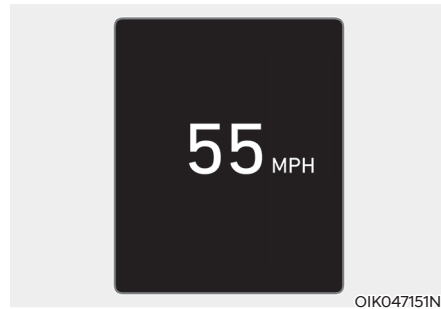

The digital speedometer display shows the speed of the vehicle.

### Auto Stop accumulated time

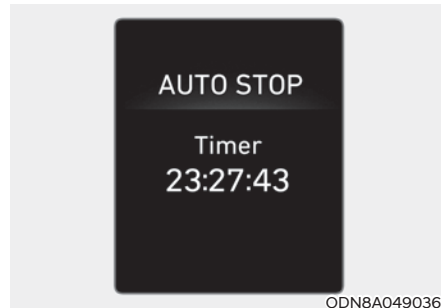

This mode displays the Auto Stop accumulated time within ISG vehicles.

**Smart shift**

This mode displays the currently selected drive mode.

**For more information, refer to "Drive Mode Integrated Control System" in chapter 6.**

## LCD DISPLAY (TYPE B)

### LCD Display Control



OCN7040023L

The LCD display modes can be changed by using the control buttons.

Switch	Operation	Function
	Tap	MODE button for changing view modes
	Tap	MOVE switch for changing items
OK	Tap	SELECT/RESET button for setting the selected item
	Tap and hold	SELECT/RESET button for retrieving assist information or resetting the selected item

#### Information

**When the infotainment system is applied, only the User's Setting mode on the infotainment system is supported but the User's Setting mode on the instrument cluster is not supported.**

### View modes

View Modes	Explanation
Utility group	The Utility group displays driving information such as the trip distance, fuel economy and etc.
Driving assist group	The Driving Assist mode displays the driving status.
Navigation group	This mode displays the state of the navigation.
Driving info. group	Display for 4 seconds when the vehicle mode changes from IGN ON to OFF.

**The information provided may differ depending on which functions are applicable to your vehicle.**

### **Utility group**

The Utility group displays information related to vehicle driving parameters including fuel economy and trip distance information.

#### **Utility Items**

The utility items appear as well in utility view mode, driving assist view mode and turn by turn view mode. The utility items in utility view mode display in the center of the instrument cluster but the items in other modes show up on the right side of the instrument cluster.

The information provided may differ depending on which functions are applicable to your vehicle

#### **Driving Information**

The trip distance for each ignition cycle, fuel economy (undisplayed item in fuel economy: driving speed), trip time are shown. Press and hold OK button to initialize set up. When the engine has been OFF for 4 hours or longer the average fuel economy will reset automatically.

#### **Information after Refueling**

The vehicle information such as trip distance, fuel economy (undisplayed item in fuel economy: driving speed) and trip time is displayed after refueling. Press and hold OK button to initialize set up.

### **Accumulated Information**

The vehicle information such as trip distance, fuel economy (undisplayed item in fuel economy: driving speed) and trip time is displayed after manual initialization.

#### **Digital Speed Display**

It shows current vehicle speed.

#### **Auto Stop accumulated time**

This mode displays the Auto Stop accumulated time within ISG vehicles.

#### **Driver Attention Warning**

Display the status of the Driver Attention Warning system. When the engine is off or the vehicle comes to a stop, the system is reset. Press and hold OK button to initialize set up.

#### **Tire pressure**

#### **Smart shift**



**Driving Assist group****SCC/LFA/HDA**

This group displays the state of Smart Cruise Control, Lane Following Assist and Highway Driving Assist.

**For more details, refer to each function information in chapter 7.**

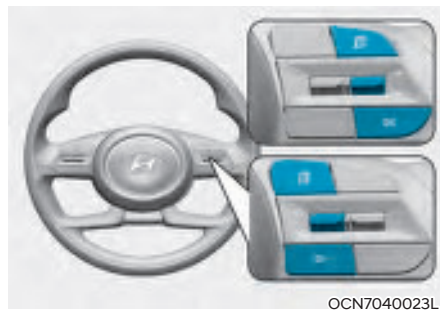
**Navigation group**

It shows the information by interworking with the navigation.

**Driving info. group****Driving information summary (1)**

The current operation conditions of the Cruise Control mode, Smart Cruise Control and Highway Driving Assist modes.

**Driving information summary (2)**

The current operation conditions of the Cruise Control mode, Smart Cruise Control and Highway Driving Assist modes.

### **Warning message group**

When the warning message light appears, check the detailed information in warning message group.

### **User settings mode**

In this mode, you can change the settings of the instrument cluster, doors, lamps, etc.

1. Driver Assistance
2. Door
3. Lights
4. Sound
5. Convenience
6. Service interval
7. Theme selection
8. Other
9. Language
10. Reset

**The information provided may differ depending on which functions are applicable to your vehicle.**

### **Shift to P to edit settings / Engage parking brake to edit settings**

This warning message illuminates if you try to select an item from the User Settings mode while driving.

- Intelligent variable transmission  
For your safety, change the User Settings after parking the vehicle, applying the parking brake and moving the shift level to P(Park).
- Manual transmission  
For your safety, change the User Settings after engaging the parking brake.

### **Quick guide (Help)**

This mode provides quick guides for the systems in the User Settings mode.

Select an item, press and hold the OK button.

**For more details about each system, refer to this Owner's Manual.**

## 1. Driver Assistance

Items	Explanation
Driving Assist	<ul style="list-style-type: none"> <li>Highway Driving Assist: The function assists the driver to maintain the set speed, keep a safe distance with a vehicle ahead and help keep the vehicle inside of the lane while driving on the highway.</li> </ul> <p><b>For more details, refer to the "Highway Driving Assist (HDA)" in chapter 7.</b></p>
Speed limit (if equipped)	<p>To adjust the Speed Limit function.</p> <ul style="list-style-type: none"> <li>Speed Limit Offset</li> <li>Auto Speed Change</li> <li>Speed Limit Assist/Speed Limit Warning/Off</li> </ul> <p><b>For more details, refer to the "Intelligent Speed Limit Assist (ISLA)" in chapter 7.</b></p>
Warning Timing	<p>To adjust the warning timing of the driver assistance system.</p> <ul style="list-style-type: none"> <li>Normal / Late</li> </ul>
Warning Volume	<p>To adjust the warning volume of the driver assistance system.</p> <ul style="list-style-type: none"> <li>High / Medium / Low / Off</li> </ul>
Driver Attention Warning	<ul style="list-style-type: none"> <li>Leading Vehicle Departure Alert</li> </ul> <p>To activate or deactivate the Leading vehicle departure alert.</p> <ul style="list-style-type: none"> <li>Inattentive Driving Warning</li> </ul> <p>To activate or deactivate the Driver Attention Warning.</p> <p><b>For more details, refer to the "Driver Attention Warning (DAW)" in chapter 7.</b></p>
Forward Safety	<p>To adjust Forward Collision-Avoidance Assist function.</p> <ul style="list-style-type: none"> <li>Active Assist/Warning only/Off</li> </ul> <p><b>For more details, refer to the "Forward Collision-Avoidance Assist (FCA)" in chapter 7.</b></p>
Lane Safety	<p>To adjust the Lane Keeping Assist function.</p> <ul style="list-style-type: none"> <li>Lane Keeping Assist/Lane Departure Warning/Off</li> </ul> <p><b>For more details, refer to "Lane Keeping Assist (LKA)" in chapter 7.</b></p>
Blind-Spot Safety	<ul style="list-style-type: none"> <li>Safe Exit Warning (SEW)</li> </ul> <p>To activate or deactivate the Safe Exit Warning.</p> <p><b>For more details, refer to the "Safe Exit Warning (SEW)" in chapter 7.</b></p> <ul style="list-style-type: none"> <li>Active Assist/Warning only/Off</li> </ul> <p><b>For more details, refer to "Blind-Spot Collision Warning (BCW)" or "Blind-Spot Collision-Avoidance Assist (BCA)" in chapter 7.</b></p>

## Instrument Cluster

---

Items	Explanation
Parking Safety	<ul style="list-style-type: none"><li data-bbox="483 495 773 527">• Rear Cross-Traffic Safety</li></ul> To Activate or deactivate the Rear Cross-Traffic Collision-Avoidance Assist function. <ul style="list-style-type: none"><li data-bbox="483 583 837 615">• Active Assist/Warning only/Off</li></ul> <b>For more details, refer to “Rear Cross-Traffic Collision-Avoidance Assist (RCCA)” in chapter 7.</b>

## 2. Door

Items	Explanation
Auto Lock	<ul style="list-style-type: none"> <li>• Enable on Shift: All doors will be automatically locked if the shift lever is moved from the P (Park) position to the R (Reverse), N (Neutral), or D (Drive) position. (Only when the engine is running)</li> <li>• Enable on Speed: All doors will be automatically locked when the vehicle speed exceeds 15km/h (9.3mph).</li> <li>• Disable : The auto door lock operation will be deactivated.</li> </ul>
Auto Unlock	<ul style="list-style-type: none"> <li>• On Shift to P: All doors will be automatically unlocked if the shift lever is moved to P (Park) position. (Only when the engine is running)</li> <li>• On key out/Vehicle Off : All doors will be automatically unlocked when the ignition key is removed from the ignition switch or the Engine Start/Stop button is set to the OFF position.</li> <li>• Disable : The auto door unlock operation will be canceled.</li> </ul>
Two Press Unlock	<ul style="list-style-type: none"> <li>• Off: The two press unlock function will be deactivated. Therefore, all doors will unlock if the door unlock button is pressed.</li> <li>• On: Only the driver's door will unlock if the door unlock button is pressed. When the door unlock button is pressed again within 4 seconds, the remaining doors will unlock.</li> </ul>
Horn Feedback	To activate or deactivate the horn feedback. If the horn feedback is activated, after locking the door by pressing the lock button on the remote key, and pressing it again within 4 seconds, the horn feedback sound will operate once to indicate that all doors are locked (if equipped with remote key).
Smart Trunk	To activate or deactivate the smart trunk. <b>For more details, refer to "Smart trunk" in chapter 5.</b>

## 3. Lights

Items	Explanation
Illumination	To adjust the illumination level. - Level 1~20
One Touch Turn Signal	<ul style="list-style-type: none"> <li>• Off: The one touch turn signal function will be deactivated.</li> <li>• 3, 5, 7 Flashes: The turn signal indicator will blink 3, 5, or 7 times when the turn signal lever is moved slightly.</li> </ul> <b>For more details, refer to "Lighting" in chapter 5.</b>
Headlight Delay	<ul style="list-style-type: none"> <li>• To activate or deactivate the headlamp delay function.</li> </ul> <b>For more details, refer to "Lighting" in chapter 5.</b>
High Beam Assist	<ul style="list-style-type: none"> <li>• To activate or deactivate the High Beam Assist function.</li> </ul> <b>For more details, refer to "High Beam Assist (HBA)" in chapter 5.</b>

4. sound

Items	Explanation
Cluster Voice Guidance Volume	To adjust the cluster voice guidance volume.
Welcome sound	To activate or deactivate the welcome sound.

5. Convenience

Items	Explanation
Seat Easy Access	<ul style="list-style-type: none"> <li>Off: The seat easy access function is deactivated.</li> <li>Normal/Extended: When you turn off the engine, the driver's seat will automatically move rearward short (Normal) or long (Extended) for you to enter or exit the vehicle more comfortably.</li> </ul> <p><b>For more details, refer to "Driver Position Memory System" in chapter 5.</b></p>
Rear Occupant Alert	<ul style="list-style-type: none"> <li>To activate or deactivate the rear occupant alert system.</li> </ul> <p><b>For more details, refer to the "Rear Occupant Alert (ROA)" in chapter 5.</b></p>
Welcome Light	<ul style="list-style-type: none"> <li>On door unlock: The welcome light turns on automatically when the doors are unlocked.</li> <li>On driver approach: The welcome light turns on automatically when the vehicle is approached with the smart key.</li> </ul> <p><b>For more details, refer to "Welcome System" in chapter 5.</b></p>
Wireless Charging System	To activate or deactivate the wireless charging system in the front seat. <b>For more details, refer to "Wireless cellular phone charging system" in chapter 5.</b>
Traffic Information	To activate or deactivate the traffic information. When activated, the traffic information will be displayed on the LCD display. (for cluster type B)
Tunnel Entry Assist	Automatically adjusts climate controls upon entering a tunnel.
Icy Road Warning	To activate or deactivate the icy road warning function.

## 6. Service interval

Items	Explanation
Enable Service Interval	To activate or deactivate the service interval function.

**To use the service interval menu, consult an authorized HYUNDAI dealer.**

If the service interval is activated and the time and distance is adjusted, messages are displayed in the following situations each time the vehicle is turned on.

- Service in  
: Displayed to inform the driver the remaining mileage and days to service.
- Service required  
: Displayed when the mileage and days to service has been reached or passed.

### Information

**If any of the following conditions occur, the mileage and number of days to service may be incorrect.**

- **The battery cable is disconnected.**
- **The fuse switch is turned off.**
- **The battery is discharged.**

## 7. Theme selection

To select the style of instrument cluster graphic style and setting.

- Theme A / Theme B / Theme C
- Link to Drive Mode

**8. Other**

Items	Explanation
Reset fuel economy	<ul style="list-style-type: none"> <li>At vehicle start : This displays the average fuel economy after restarting.</li> <li>After refueling : This displays the average fuel economy after refueling.</li> <li>Manually : You can calculate the accumulated average fuel economy manually.</li> </ul>
Fuel Econ. Reset	<ul style="list-style-type: none"> <li>Off: The average fuel economy will not reset automatically whenever refueling.</li> <li>After ignition: When the engine has been OFF for 4 hours or longer the average fuel economy will reset automatically.</li> <li>After refueling: The average fuel economy will reset automatically after adding 6 liters (1.6 gallons) of fuel or more and after driving speed exceeds 1 km/h (1 mph).</li> </ul> <p><b>For more details, refer to “Trip Computer” in this chapter.</b></p>
Speed Unit (if equipped)	To select the speed unit. (km/h, MPH)
Fuel Econ. Unit	To select the fuel economy unit. (km/L, L/100km, MPG)
Temperature Unit	To select the temperature unit. (°C, °F)
Tire Pressure Unit	To select the tire pressure unit. (psi, kPa, bar)

**9. Language (if equipped)**

Items	Explanation
Language	Choose the language. You can choose the language in infotainment system. (if equipped)

**10. Reset**

Items	Explanation
Reset	You can reset the menus in the User Settings Mode. All menus in the User Settings Mode are reset to factory settings, except language and service interval.



## 5. Convenient Features

---

Accessing Your Vehicle.....	5-4
Remote Key.....	5-4
Smart Key.....	5-7
Immobilizer System .....	5-14
Hyundai Digital Key.....	5-15
Operating Door Locks from Outside the Vehicle .....	5-31
Operating Door Locks from Inside the Vehicle .....	5-33
Automatic Door Lock and Unlock Features.....	5-35
Child-Protector Rear Door Locks .....	5-35
Rear Occupant Alert (ROA) System.....	5-36
Steering Wheel.....	5-38
Electric Power Steering (EPS).....	5-38
Tilt Steering / Telescope Steering .....	5-39
Horn.....	5-40
Mirrors .....	5-41
Inside Rearview Mirror .....	5-41
Side View Mirrors .....	5-49
Windows.....	5-51
Power Windows.....	5-52
Sunroof.....	5-55
Sunroof opening and closing .....	5-56
Tilting the sunroof .....	5-57
Sunshade .....	5-57
Resetting the sunroof .....	5-58
Sunroof open warning .....	5-58
Hood .....	5-59
Trunk.....	5-61
Emergency trunk safety release.....	5-62
Smart Trunk release .....	5-63
Fuel filler door .....	5-66
Exterior Lights .....	5-68
Lighting control.....	5-68
High beam operation .....	5-69
Turn signals and lane change signals .....	5-70
Battery saver function.....	5-71
Headlamp delay function .....	5-71

---

High Beam Assist (HBA) .....	5-72
Detecting sensor (Front view camera).....	5-72
Function settings.....	5-72
Function operation.....	5-73
Function malfunction and limitations.....	5-73
Interior Lights .....	5-75
Interior lamp AUTO cut .....	5-75
Front lamps.....	5-75
Rear lamp.....	5-76
Luggage compartment lamp .....	5-77
Vanity mirror lamp.....	5-77
Welcome system .....	5-78
Wipers and Washers .....	5-79
Windshield Wipers .....	5-79
Windshield Washers.....	5-80
Manual Climate Control System .....	5-81
Heating and Air Conditioning.....	5-82
System operation .....	5-88
System Maintenance .....	5-90
Automatic Climate Control System .....	5-92
Automatic heating and air conditioning.....	5-93
Manual heating and air conditioning.....	5-94
System operation .....	5-100
System Maintenance .....	5-102
Windshield defrosting and defogging.....	5-104
Manual climate control system .....	5-104
Automatic climate control system .....	5-105
Defogging logic .....	5-106
Auto defogging system (only for automatic climate control system) .....	5-107
Defroster .....	5-108
Climate control additional features.....	5-109
Sunroof inside air recirculation .....	5-109
Auto comfort control (for driver's seat).....	5-109
Automatic ventilation.....	5-109
Storage compartment .....	5-110
Center console storage.....	5-110
Glove box .....	5-110

## 5. Convenient Features

---

Interior Features.....	5-111
Cup Holder.....	5-111
Sunvisor .....	5-112
Power Outlet.....	5-112
USB Charger .....	5-113
Wireless Cellular Phone Charging System .....	5-114
Clock .....	5-116
Clothes Hanger.....	5-116
Infotainment System .....	5-117
USB Port.....	5-117
Antenna.....	5-118
Steering wheel audio control .....	5-119
Infotainment system .....	5-120
Voice recognition .....	5-120
Bluetooth® Wireless Technology hands-free.....	5-120
How vehicle radio works.....	5-121

## ACCESSING YOUR VEHICLE

### Remote Key (if equipped)



Your HYUNDAI uses a remote key, which you can use to lock or unlock the driver and passenger doors or the rear trunk.

- (1) Door Lock
- (2) Door Unlock
- (3) Trunk Unlock
- (4) Panic

#### **Locking your vehicle**

To lock your vehicle:

1. Make sure all doors, the engine hood and the trunk are closed.
2. Press the Door Lock button (1) on the remote key to lock all doors.
3. The doors will lock and the hazard warning lights will blink.
4. Make sure the doors are locked by checking the position of the door lock button inside the vehicle.

#### **WARNING**

**Do not leave the keys in your vehicle with unsupervised children. Unattended children could place the key in the ignition switch and may operate power windows or other controls, or even make the vehicle move, which could result in serious injury or death.**

#### **Unlocking your vehicle**

To unlock your vehicle:

1. Press the Door Unlock button (2) on the remote key.
2. The driver's door will unlock. The hazard warning lights will blink two times.
  - Two press unlock setting:  
If you press the Door Unlock button on the remote key again within four seconds, then all the doors will unlock.  
Two press unlock setting can be changed according to owner's preference in the cluster User Settings mode.
  - User settings mode method:  
Select or deselect the 'Two Press Unlock' feature in the User Settings mode on the cluster LCD display (User Settings → Door → Two Press Unlock).

#### **Information**

**After unlocking the doors, the doors will automatically relock after 30 seconds unless a door is opened.**

**Trunk unlocking**

To unlock the trunk :

1. Press and hold the Trunk Unlock button (3) on the remote key for more than one second.
2. The hazard warning lights will blink two times and the trunk will be unlocked.
3. Once the trunk is opened and then closed, the trunk will automatically lock.

**i Information**

The word “HOLD” is written on the button to inform you that you must press and hold the button for more than one second.

**Panic button**

Press and hold the Panic button (4) for more than one second. The horn sounds and hazard warning lights flash for about 30 seconds.

To cancel the panic mode, press any button on the remote key.

**Start-up**

For information, refer to the “Key Ignition Switch” section in chapter 6.

**NOTICE**

To prevent damaging the remote key:

- **Keep the remote key away from water or any liquid and fire. Internal circuits may malfunction if the inside of the remote key gets damp (from liquids or moisture) or if it is heated. This can exclude the remote key from being covered under warranty.**
- **Avoid dropping or throwing the remote key.**
- **Protect the remote key from extreme temperatures.**

**Mechanical key**

OIG046004

If the remote key does not operate normally, you can lock or unlock the driver's door by using the mechanical key.

To unfold the mechanical key, press the release button on the remote.

To return the key to its stored position, press the release button and fold the key back into the remote.

**Remote key precautions**

The remote key will not work if any of the following occur:

- The key is in the ignition switch.
- You exceed the operating distance limit (about 33 feet [10 m]).
- The remote key battery is weak.
- Other vehicles or objects may be blocking the signal.
- The weather is extremely cold.
- The remote key is close to a radio transmitter such as a radio station or an airport which can interfere with normal operation of the remote key.

If the remote key does not work correctly, open and close the door with the mechanical key. If you have a problem with the remote key contact an authorized HYUNDAI dealer.

If the remote key is in close proximity to your mobile phone, the signal could be blocked by your mobile phone's normal operational signals. This is specifically relevant when the phone is active such as making and receiving calls, text messaging, and/or sending/receiving emails.

When possible, avoid placing the remote key and your mobile phone in the same location such as a pants or jacket pocket in order to avoid interference between the two devices.

### **i** Information

This device complies with Part 15 of the FCC rules.

Operation is subject to the following three conditions:

1. This device may not cause harmful interference.
2. This device must accept any interference received, including interference that may cause undesired operation.
3. Changes or modifications not expressly approved by the party responsible for compliance could void the user's authority to operate the device.

### **NOTICE**

Keep the remote key away from electromagnetic materials that block electromagnetic waves to the key surface.

### **Battery replacement**



If the remote key is not working properly, try replacing the battery with a new one.

Battery Type: CR2032

To replace the battery:

1. Insert a slim tool into the slot and gently pry open the cover.
2. Using a screw driver, remove the battery cover.
3. Remove the old battery and insert the new battery. Make sure the battery position is correct.
4. Reinstall the battery cover and key cover in the reverse order of removal.

If you suspect your remote key might have sustained some damage, or you feel your remote key is not working correctly contact an authorized HYUNDAI dealer.

### **i** Information



An inappropriately disposed battery can be harmful to the environment and human health. Dispose of the battery according to your local law(s) or regulation.

### Smart Key (if equipped)

■ Type A



OCN7050004

■ Type B



OCN7050005

Your HYUNDAI uses a smart key, which you can use to lock or unlock a door (and trunk) and even start the engine even just carrying the key.

- (1) Door Lock
- (2) Door Unlock
- (3) Trunk Open
- (4) Panic
- (5) Remote Start (if equipped)

### Locking your vehicle (Button type)

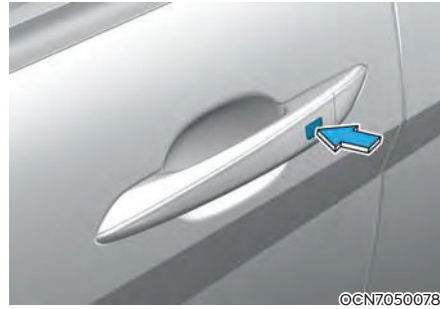

OCN7050078

1. Close all doors, engine hood and trunk.
2. Carry the smart key.
3. Either press the door handle button or press the Door Lock button (1) on the smart key.
4. The hazard warning lights will blink.
5. Make sure the doors are locked by pulling the door outside handle.

### **i** Information

**The door handle button will only operate when the smart key is within 28-40 inches (0.7-1 m) from the outside door handle.**

**Locking your vehicle  
(Touch sensor type) (if equipped)**



1. Close all doors, engine hood and trunk.
2. Carry the smart key.
3. Either touch the touch sensor on the door handle (the engraved part) or press the Door Lock button (1) on the smart key.
4. The hazard warning lights will blink.
5. Make sure the doors are locked by pulling the door outside handle.

***i* Information**

- The door handle button will only operate when the smart key is within 28~40 inches (0.7~1 m) from the outside door handle.
- If you locked the door with the touch sensor on the door handle, the doors cannot be unlocked with the sensor within 3 seconds.

***i* Information**

Even though you press the outside door handle button or touch the touch sensor, the doors will not be locked and the chime will sound for 3 seconds if any of the following occurs:

- The Smart Key is in the vehicle
- The Engine Start/Stop button is in ACC or ON position.
- Any door except the trunk is opened.

** CAUTION**

When you leave your vehicle with the smart key, make sure to press the button on the front door handle or touch the touch sensor on the front door handle to lock the doors after closing all of the doors, the hood and the trunk. If you do not press the button or touch the touch sensor firmly, the doors might not be locked so please use caution.

** WARNING**

Do not leave the Smart Key in your vehicle with unsupervised children. Unattended children could press the Engine Start/ Stop button and may operate power windows or other controls, or even make the vehicle move, which could result in serious injury or death.



### Unlocking your vehicle (When the Two Press Unlock feature is off)

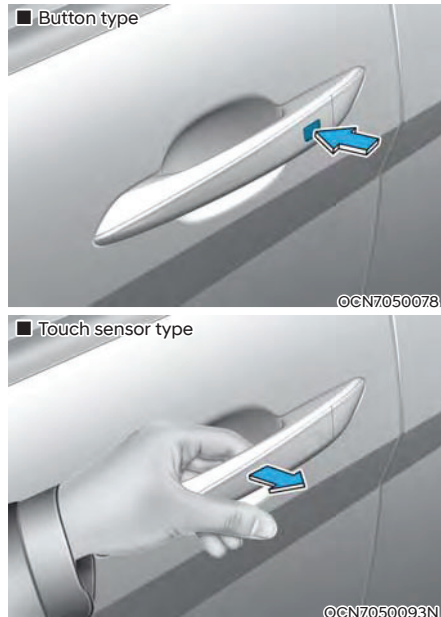

1. Make sure you have the smart key in your possession.
2. Press the Door Unlock button (2) on the smart key, press the button on the front door handle or touch the door unlock sensor inside of the front door handle to unlock the doors.
3. All of the doors will unlock. When the doors unlock, the hazard warning lights will blink two times.
  - The door handle button will only operate when the smart key is within 28~40 inches (0.7~1 m) from the outside door handle.
  - If you do not open the door after unlocking within 30 seconds, it will return to the lock mode.
  - If you unlocked the door with the door handle, the doors cannot be locked with the sensor for up to 2 seconds.

### Unlocking your vehicle (When the Two Press Unlock feature is on)

1. Make sure you have the smart key in your possession.
2. Press the Door Unlock button (2) on the smart key, press the button on the front door handle or touch the door unlock sensor inside of the front door handle to unlock the doors.
3. The driver's door will unlock.
4. If you press the button on the front door handle or touch the door unlock sensor inside of the front door handle to unlock the doors within 4 seconds, all of the doors unlock. When the doors unlock, the hazard warning lights will blink two times.
  - The door handle button will only operate when the smart key is within 28~40 inches (0.7~1 m) from the outside door handle.
  - If you do not open the door after unlocking within 30 seconds, it will return to the lock mode.
  - The factory default setting is in off mode so you should set in the User's Settings mode.
  - If you unlocked the door with the door handle, the doors cannot be locked with the sensor for up to 2 seconds.

### Two Press Unlock Feature

The priority for unlocking the driver door only, or unlocking all the doors with one press may be adjusted in the User Settings mode in the cluster LCD display.

The Two Press Unlock feature, when enabled, will require the user to press the door unlock button once for driver door only and twice for unlocking all the doors.

Select or Deselect the Two Press Unlock feature in the User Settings mode in the cluster LCD display. The option can be found under the following menu:

User Settings → Door → Two Press Unlock

### Information

**If you press the front passenger outside door handle with the smart key in your possession, all the doors will unlock.**

### **Trunk opening**

To open:

1. Make sure you have the smart key in your possession and either press inside the trunk emblem or press the Trunk Unlock button (3) on the smart key for more than one second.
2. Once the trunk is opened, the hazard warning lights will blink two times.
  - The trunk handle button will only operate when the smart key is within 28~40 inches (0.7 ~1 m) from the trunk handle.
  - Once the trunk is opened and then closed, the trunk will automatically lock.

### **Panic button**

Press and hold the Panic button (4) for more than one second. The horn sounds and hazard warning lights flash for about 30 seconds. To cancel the panic mode, press any button on the smart key.

**Remote start (if equipped)**

You can start the engine and turn on the climate system by pressing the remote start button (5) outside the vehicle.

To start and stop engine remotely :

1. Press the door lock button (1), and then the hazard warning lights blink once to alert you.
2. Press the Remote Start button (5) for more than 2 seconds to start the engine within 4 seconds after pressing the door lock button (1).
3. If you want to stop the engine, press the Remote Start button (5) again.

In case of the manual operation, the climate control system will be maintained even when the engine is turned OFF. However, the automatic operation is set to 72°F (22°C).

If someone without a designated smart key attempts to drive your vehicle after you remotely started it, the engine will be stopped.

** Information**

**After remotely starting the vehicle, the engine will turn off after 10 minutes if the vehicle is not driven.**

** CAUTION**

- **The remote start will not work if you exceed the operating distance limit (about 10 m).**
- **Avoid idling the engine for prolonged periods to follow the emission regulations in your locality.**
- **Laws in your locality may restrict the use of remote start. You should check locality regulations before using this remote starting system.**
- **It is only possible to start the engine remotely when shifted to P (Park).**
- **If the hood or the trunk is opened, you cannot start the engine remotely.**

### Start-up

You can start the engine without inserting the key. For detailed information refer to the Engine Start/ Stop button in chapter 6.

### **i** Information

If the smart key is not moved for some time, the detection function for smart key operation will pause. Lift the smart key to activate the detection again.

### **NOTICE**

To prevent damaging the smart key:

- Keep the smart key away from water or any liquid and fire. If the inside of the smart key gets damp (due to drinks or moisture), or is heated, internal circuit may malfunction and may void the vehicle warranty.
- Avoid dropping or throwing the smart key.
- Protect the smart key from extreme temperatures.

### **NOTICE**

Always have the smart key with you when leaving the vehicle. If the smart key is left near the vehicle, the vehicle battery may be discharged.

### Mechanical key

If the Smart Key does not operate normally, you can lock or unlock the driver's door by using the mechanical key.

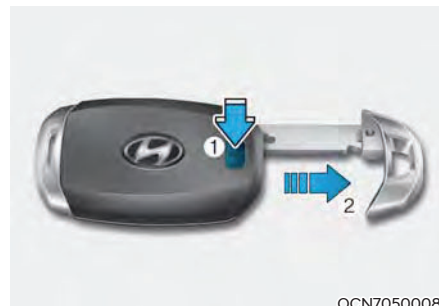

OCN7050008

Press and hold the release button (1) and remove the mechanical key (2). Insert the mechanical key into the key hole on the door.

To reinstall the mechanical key, put the key into the hole and push it until a click sound is heard.

### Loss of a smart key

A maximum of two Smart Keys can be registered to a single vehicle. If you happen to lose your smart key, you should immediately take the vehicle and remaining keys to your authorized HYUNDAI dealer or tow the vehicle, if necessary.

### Smart key precautions

The smart key may not work if any of the following occur:

- The smart key is close to a radio transmitter such as a radio station or an airport which can interfere with normal operation of the transmitter.
- The smart key is near a mobile two way radio system or a cellular phone.
- Another vehicle's smart key is being operated close to your vehicle.

If the smart key does not work correctly, open and close the door with the mechanical key. If you have a problem with the smart key, contact an authorized HYUNDAI dealer.

If the smart key is in close proximity to your mobile phone, the signal could be blocked by your mobile phone's normal operational signals. This is specifically relevant when the phone is active such as making and receiving calls, text messaging, and/or sending/receiving emails. When possible, avoid keeping the smart key and your mobile phone in the same location such as a pants or jacket pocket in order to avoid interference between the two devices.

### **i** Information

This device complies with Part 15 of the FCC rules.

Operation is subject to the following three conditions:

1. This device may not cause harmful interference, and
2. This device must accept any interference received, including interference that may cause undesired operation.
3. Changes or modifications not expressly approved by the party responsible for compliance could void the user's authority to operate the device.

### **NOTICE**

Keep the smart key away from electromagnetic materials that blocks electromagnetic waves to the key surface.

### **Battery replacement**



If the Smart Key is not working properly, try replacing the battery with a new one.

Battery Type: CR2032

To replace the battery:

1. Remove the mechanical key.
2. Use a slim tool to pry open the rear cover of the smart key.
3. Remove the old battery and insert the new battery. Make sure the battery position is correct.
4. Reinstall the rear cover of the smart key.

If you suspect your smart key might have sustained some damage, or you feel your smart key is not working correctly, contact an authorized HYUNDAI dealer.

### **i** Information



An inappropriately disposed battery can be harmful to the environment and human health. Dispose of the battery according to your local law(s) or regulation.

### Immobilizer System

The immobilizer system protects your vehicle from theft. If an improperly coded key (or other device) is used, the engine's fuel system is disabled.

When the ignition switch is placed in the ON position, the immobilizer system indicator should come on briefly, then go off. If the indicator starts to blink, the system does not recognize the coding of the key.

Turn the ignition switch to the LOCK/OFF position, then turn the ignition switch to the ON position again.

In some circumstances, the vehicle may not recognize your smart key if another smart key device is nearby or a metal object such as a key chain is causing interference with the smart key.

If this occurs, your vehicle may not start. Remove any metal objects or additional keys near the smart key before attempting to start the vehicle again.

If the system repeatedly does not recognize the coding of the key, it is recommended that you contact your HYUNDAI dealer.

Do not attempt to alter this system or add other devices to it. Electrical problems could result that may make your vehicle inoperable.

### WARNING

**In order to prevent theft of your vehicle, do not leave spare keys anywhere in your vehicle. Your immobilizer password is a customer unique password and should be kept confidential.**

### **NOTICE**

**The transponder in your key is an important part of the immobilizer system. It is designed to give years of trouble-free service, however you should avoid exposure to moisture, static electricity and rough handling. Immobilizer system malfunction could occur.**

### Information

**This device complies with Part 15 of the FCC rules.**

**Operation is subject to the following three conditions:**

- 1. This device may not cause harmful interference.**
- 2. This device must accept any interference received, including interference that may cause undesired operation.**
- 3. Changes or modifications not expressly approved by the party responsible for compliance could void the user's authority to operate the device**

## Hyundai Digital Key (if equipped)

### Digital Key Application

To use Hyundai Digital Key mobile app, you should install Hyundai digital key application. Search 'Hyundai digital key' in the Google Play Store and download the app. Please refer to the detailed manual of the digital key app. The option can be found under the following app menu:

#### Menu → Application Info → Tutorial

Please note the manual before using the app.

- \* This service is only available for Android smartphones. Please confirm supported/compatible devices on our website.



### WARNING

#### For used vehicle

If any of the digital key (smartphone key or card key) is already registered when you press ON button after unlocking the doors, the message 'Digital key(s) active' appears on the instrument cluster once. If you buy a used vehicle, you should confirm the message and delete the registered smartphone key and card key. In addition, please notify the Hyundai Customer Care Center.

If the card key does not work properly, please delete the card key and register the smartphone key and re-register the card key.

#### For vehicle maintenance

If you need to have your Digital Key System repaired or replaced please ensure your Smartphone Key is still active. You may have to pair your phone again.

In this case, re-initialize your Digital Keys using the Hyundai Digital Key mobile app.

### Digital key (smartphone) NFC function

You can use the Digital Key NFC (Near Field Communication) function after turning on your smartphone function in the NFC settings. And you should unlock & turn on smartphone screen to use it.

- \* To change the NFC mode of the smartphone, please refer to the smartphone manual or contact to the customer service center of smartphone manufacturers.

### Digital key (smartphone)

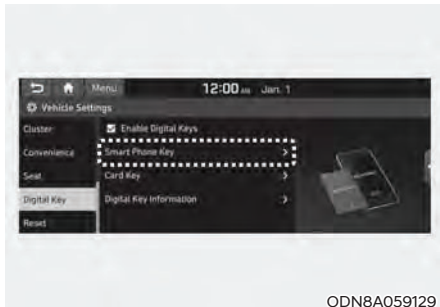

ODN8A059129



ODN8A059240

#### Hyundai Digital Key (Smartphone) Pairing

1. Turn the vehicle on with the Smart key and make sure to keep the smart key inside the vehicle during digital key registration.
2. Register your Digital key from the vehicle user setting menu as follows.
  - \* With Navigation screen :  
From the infotainment screen menu, go to [Setup] - [Vehicle] - [Digital Key] - [Smart Phone Key] then select the [Save] from submenu.
  - \* Without navigation screen :  
From cluster menu, go to [Digital Key] - [Smart Phone Key] and select [Save].

### **i** Information

The [Save] button will be disabled if the digital key (Smartphone key) is already saved.

Please refer to “Digital Key Delete” in this manual and follow the digital key delete procedure in your car before attempting a Digital key save.

Please refer to the ‘Tutorial’ on your Digital key app and delete the previous saved key in your smartphone before attempting a save.

3. Select the vehicle to save on your Digital key application and activate the save mode.
- \* Save mode is available only on the vehicle owner’s Digital key application.
4. Place the backside of smartphone onto the wireless charging pad (in-vehicle authentication pad). The saving process will begin automatically.
5. Once the digital key save is complete, a message will be shown on the infotainment screen or cluster.
6. Remove the smartphone from the pad and complete the saving process.



OCN7050070

[A] : Wireless Charging Pad (In-vehicle Authentication Pad)



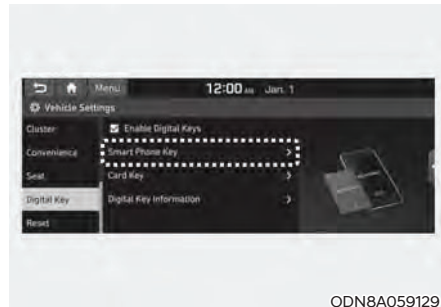

ODN8A059129



ODN8A059130

### Hyundai Digital Key (Smartphone Key) Deletion

1. Turn the vehicle on with the Smart key and make sure to keep the smart key inside the vehicle during delete process.
2. Delete your Digital key from the vehicle user setting menu as follows.
  - \* With Navigation screen :  
From the infotainment screen menu, go to [Setup] - [Vehicle] - [Digital Key] - [Smart Phone Key] then select the [Delete] from submenu.
  - \* Without navigation screen :  
From cluster menu, go to [Digital Key] - [Smart Phone Key] and select [Delete].

### **i** Information

The [Delete] button will be disabled if there is no digital key (Smartphone key) saved.

3. Once the digital key delete is complete, a message will be shown on the infotainment screen or cluster.
4. Go to [Initialize Digital Key] menu on the digital key application and select the vehicle to delete the digital key information.
  - Open the Hyundai Digital Key app → Menu → Initialize Digital Key
  - \* If the saved digital key information in your car is deleted due to vehicle maintenance, the digital key in your smartphone should be deleted as well.
  - \* For more information, please refer to the 'Tutorial' on your Digital key app.

### **!** CAUTION

- If the smartphone is removed from the interior authentication pad during enrollment, the saving process will be cancelled.
- If the infotainment or instrument cluster screen is changed during enrollment, the saving process will be cancelled.
- If the vehicle is turned off during enrollment, the saving process will be cancelled.
- If the gear is shifted, the saving process will be cancelled.
- If you try to save the smartphone which is not logged in with the vehicle owner's ID or if you try to save the Card key, the saving process will not begin.
- If the NFC setting on your smartphone is off, the saving process will not begin.
- If the smartphone screen is changed to off or locked status, the saving process will be cancelled.
- If there is no Smart key during the save process, the saving process will not begin.

## Convenient Features

---

### Set up main vehicle

You can manage multiple digital keys from the Digital key app. From the list of digital keys you own, select the vehicle you want to make your priority vehicle.

**For more information, please refer to the 'Tutorial' on your Digital key app.**

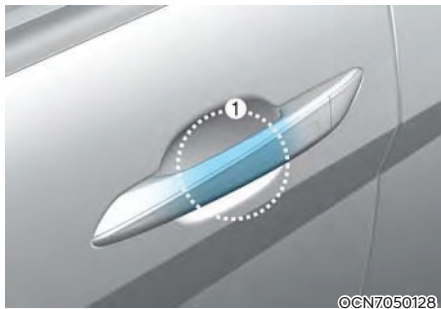

[1] : Door handle authentication pad

### NFC door lock/unlock

You should touch your smartphone's NFC antenna (backside of phone) to door handle authentication pad (1) marked position near by the lock button) of driver's (or front passenger's) outside door for 2 seconds to lock or unlock the doors. If the Two Press Unlock feature is applied (press twice for unlocking), driver's seat door will be unlocked by touching the digital key (smartphone key). In this state, if you touch one more time within 4 seconds, all the doors unlock. Please make sure the doors are locked. If you do not open any of the doors after unlocking, it automatically re-lock after 30 seconds.

Note that you cannot lock your vehicle when you touch NFC antenna in the smartphone to the door handle pad if any of the following occurs:

- The Proximity / Smart Key is in the vehicle.
- The POWER button is in ACC or ON position.
- Any of the doors, hood or trunk is opened.

If the smartphone digital key does not work, please remove the smartphone more than 4 inches (0.1 m) from the door handle authentication pad and try it again.

### Start-up with Digital Key

1. After placing your registered smartphone onto the interior authentication pad (wireless charger), step on the brake and press the Engine Start/Stop button.
2. After start-up, the digital key data will be automatically updated. It takes 5 to 20 seconds, after that, the smartphone will go into the wireless charging mode automatically. Once the engine is started, you may remove the smartphone from the pad.



[A] : Wireless Charging Pad (In-vehicle Authentication Pad)

### **i** Information

After reconnecting the vehicle battery power supply or charging the battery, it may take time to operate due to remote renewal of security information. When you lock or unlock the door with NFC, please touch and hold your smartphone on the door handle until it works.

When the mobile data connection of the smartphone is weak, the remote renewal of security information may fail. In this case, you should lock, unlock or turn on the vehicle with the card key. When you are in the place where the mobile data connection of your smartphone is available and place your smartphone on the interior authentication pad (wireless charger) and start up your vehicle or touch the digital key on the door handle to lock or unlock the door, the remote renewal of security information starts automatically. Even though the engine is turned on, please wait until the remote renewal process is completed and wireless charger is converted to charging mode.

### **!** CAUTION

The engine can be turned on if the registered smartphone or card key is placed on the interior authentication pad (wireless charger). Do not leave unsupervised children or people who are not aware of the system since it can result in serious injury or death. Always have the registered digital key (smartphone) or card key with you to prevent vehicle theft when leaving the vehicle.

For more information, refer to the Engine Start/Stop button in chapter 6.

### Remote Control with Digital Key

To use the remote control function with your android smartphone, Bluetooth must be turned on.

#### *Remote Control Connection with Digital Key*

1. Open Hyundai digital key application on the smartphone. Select the vehicle to activate the remote control function as a main vehicle.
2. Approach with the activated smartphone app to your vehicle and you can check whether the connection is available. If it enables your smartphone to connect, connect with your vehicle by pressing the connect button. The remote control function is activated after completing the process.

#### *Remote Control Operation with Digital Key*

You can execute the remote control operation including door lock/unlock, panic on/off, remote start / remote stop and trunk opening. The icon for each function will be highlighted and alarm/vibration also provided when the operation is performed.

Note that you cannot lock your vehicle using the Hyundai digital key app if any of the following occurs:

- The POWER button is in ACC or ON position.
- Any doors are open.

When the smartphone and the vehicle are connected by the Bluetooth function but the remote control command cannot be received over 5 minutes, the remote control connection is cancelled automatically.



### CAUTION

- If metallic window tint was applied to your vehicle, it may cause bad Bluetooth connection or performance degradation of the digital key.
- If multiple users operate the remote control function simultaneously, the connection between the digital key and the vehicle might result in failed commands. Please connect and operate the remote control function only with the necessary user.
- When using the remote control operation, the driver (the remote control user) should leave the vehicle after confirming the door lock (the chime sounds once and the hazard warning lights blink).
- The remote functions of the Digital Key app enables the vehicle to be controlled from a set distance. If the digital key or the vehicle goes beyond the operable distance, the remote control function might be disconnected or cancelled.
- If the digital key (smartphone) is connected with the vehicle for the remote control, the driver with the key goes far away from the vehicle, the function might not work.
- If the remote control operation is executed where the mobile connection is weak, Bluetooth connection is poor due to several Bluetooth devices or there is an object such as metal or concrete, it might be delayed or the operable distance might decrease. You should not cover the smartphone with your hand or place other devices which can cause frequency interference. It may result in poor performance.
- If the remote control function is not available, please use NFC function to lock or unlock the doors.

*Remote Start with Digital Key*

- When the shift lever of your vehicle is in P (Park) and all of the doors including trunk and hood is locked and the vehicle is off, press the Door Lock button in the Hyundai Digital Key app then press the Remote Start button within 4 seconds. You can confirm the engine is on if the hazard warning lights blinks two times and the chime sounds.
- If you want to turn off the engine, press Remote Engine Stop. Air Conditioner / Heating system maintains the same status as when you last used the vehicle.
- Unless you put the registered digital key (smartphone) on the interior authentication pad (wireless charger) when the remote start function is on, the engine will turn off.
- If you do not get into the vehicle within 10 minutes after the engine turns on, the vehicle will turn off.

**For more information, refer to the Engine Start/Stop button in chapter 6.**

*Vehicle information Display*

The digital key application displays the vehicle information such as driving or door conditions through the communication with the vehicle.

- How to check : Select the vehicle what you want to check and touch the vehicle image, then vehicle information display page will be shown.
- Contents : accumulated odometer, latest fuel economy, driving range, fuel remaining, tire pressure, doors lock/unlock status and last data updated time.
- \* Displayed vehicle data could be differed from the current vehicle condition.
- \* **For more information, please refer to the 'Tutorial' on your Digital key app.**

**Smartphone change/App deletion**

If you change your smartphone or delete the Hyundai Digital Key App, please refer to the following to set up your Digital Key:

*Smartphone Change/ Reset*

If you change or reset the smartphone, the registered digital key in your previous smartphone may not be used. Please refer to following procedure to use the digital key.

1. Install the digital key application and log in.
2. If you are the owner, retry the Digital key save process.
3. If you are the sharer, need to re-share the key from owner.

*App delete & reinstall/ Delete App data*

You can re-download the digital key from the server and follow these procedures.

1. Reinstall the application and log in.
2. Input the PIN number for user verification.
3. If PIN is correct, digital key data will be re-downloaded to your smartphone and you can use it without any further registration or sharing.

*Smartphone operability with Digital Key*

The digital key application may not be available to older type smartphones. Please check the available smartphone models with your dealer. NFC antenna position on the smartphone can be confirmed on each smartphone's manual or contact to customer service center of the smartphone manufacturer.

 **CAUTION**

- Do not leave the registered digital key (smartphone) and card key in your vehicle. Please carry around your keys all the time.
- If you happen to lose your digital key (smartphone) or card key registered as a main user's key, you should immediately delete the key on the vehicle's key menu. For more information, refer to the Digital Key Deletion in this chapter.
- If you registered your digital key (smartphone) or card key in the vehicle, a message appears on the instrument cluster and informs you that the key is registered. (Message: Digital key(s) active.)
- If you buy a used vehicle, you should confirm the message and delete the registered smartphone key and card key. In this case, you should carry your smart key.
- If you keep the NFC card of the digital key on the interior authentication pad (wireless charger) while driving, it may cause a malfunction of the NFC card.
- You should remove your NFC card of the digital key on the interior authentication pad after turning on the engine.
- Hyundai digital key app may not work properly when the NFC or Bluetooth communication between smartphone and car is poor.
- If the remote control operation is executed where the mobile connection is weak, Bluetooth connection is poor due to other Bluetooth devices or there is an object such as metal or concrete, it might be delayed or the operable distance might decrease. You should not cover the smartphone with your hand or place other devices which can cause frequency interference. It may result in poor performance.
- If the remote control function is not activated, please use NFC function to lock or unlock the doors
- You should be careful not to press the remote control button on the digital key (smartphone) accidentally.
- If the digital key (smartphone) is discharged or defective or you cannot use the digital key since the vehicle battery is discharged, use the inside door lock button to lock all of the doors.

 **CAUTION**

- Hyundai digital key app on the smartphone and card key may not work if any of the following occurs:
  - Hyundai digital key app on the smartphone is deleted. (Required to reinstall the app)
  - Account log in information of Hyundai digital key app is expired. (Required to re-log in)
  - When you try to log in to another smartphone instead of the registered smartphone with same user account.
  - Smartphone rooting or app hacking is detected.
  - Smartphone battery or the vehicle battery is discharged.
  - Smartphone's screen is off or locked.
  - NFC or Bluetooth is turned off on the smartphone settings.
  - Smartphone's mobile network setting is off or airplane mode is activated.
  - A credit card is overlapped in the back of your smartphone or metal or thick case is used.
  - The card key is overlapped with other credit cards or the key is used as inserted in the wallet or card wallet.

- If you use a smart phone cover that uses wireless communication or is made of metal, the digital key NFC function may not work properly. Remove the smart phone cover before using the digital key NFC function.
- The vehicle may not be controlled by the smartphone if any of the following occurs:
  - Basic and necessary functions of the smartphone manufacturer are operating. (General call, urgent call, audio or NFC payment)
  - Wireless earphone is operating. (General call, urgent call or audio)
  - The digital key app function such as basic setting or app launching is limited by prior policy according to the manufacturer while using a smartphone produced by domestic and foreign manufactures.
- \* If you change the smartphone number, you should modify the user account information on the HYUNDAI customer web site to use the digital key app.
- \* If the vehicle owner changes the smartphone device, the new smartphone should be registered in the car after deleting the registered digital key(smartphone).
- \* If a sharer changes or resets the smartphone, the key should be re-shared from owner.
- \* Some older smartphones may not work properly. Please check the available smartphone models with your dealer.
- \* NFC antenna position on the smartphone can be confirmed on each smartphone's manual or contact to customer service center of the smartphone manufacturer.

### Digital key (Card key)

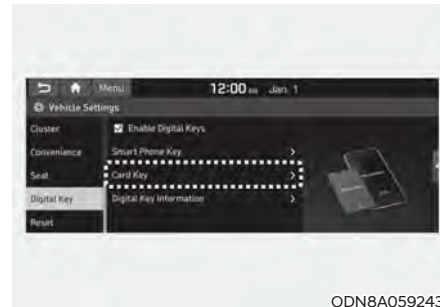

ODN8A059243



ODN8A059131

### Digital key (Card key) save

1. Install Hyundai digital key app in main user's smartphone and register the digital key (smartphone). Please refer to the registration method of the digital key (smartphone).
  2. Using the [Pair Card Key] menu on the digital key application, you can activate the Card Key registration mode.
- \* NFC authentication : enter the NFC authentication menu and touch the smartphone on the outside door handle.
  - \* Bluetooth authentication : enter the Bluetooth authentication menu and press the [OK] button for activation.  
If you activate the registration mode, you should complete the Card saving process with in 5 minutes.
  - \* If you have not registered the digital key (smartphone), please register the digital key (card key) with two smart keys.

3. Register the NFC card key on the User's Settings menu after turning on the vehicle.
- \* With Navigation screen : From the infotainment screen menu, go to [Setup] - [Vehicle] - [Digital Key] - [Card Key] then select the [Save] from submenu.

- \* Without navigation screen : From cluster menu, go to [Digital Key] - [Card Key] and select [Save].

The [Save] button will be disabled if the digital key (Card key) is already saved.

Please refer to "Digital Key Delete" in this manual and follow the digital key delete procedure in your car before Digital key save.

4. Place the NFC card key onto the interior authentication pad (wireless charger). The saving process will begin automatically.
  5. If the key is enrolled, the message will be displayed on the infotainment screen or instrument cluster.
- Once the card key registration mode is activated, the process should be completed within 5 minutes. After then, you should reactivate once again for registration.
  - For the digital key(card key) saving, the smart key(fob) must be inside the vehicle.
  - Once a Card key is registered, it cannot be reused in another vehicle.



ODN8A059243

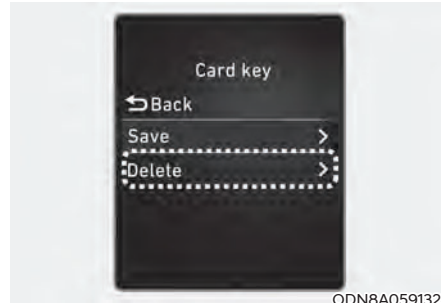

ODN8A059132

### Digital key (Card key) deletion

You should have the smart key to delete digital key (card key). Please have the smart key in your possession.

1. Get into the vehicle with the smart key.
2. Delete the NFC card key on the User's Settings menu after turning on the engine.

- \* With Navigation screen : From the infotainment screen menu, go to [Setup] - [Vehicle] - [Digital Key] - [Card Key] then select the [Delete] from submenu.

- \* Without navigation screen : From cluster menu, go to [Digital Key] - [Card Key] and select [Delete].

If there is no saved digital key(card key), [Delete] menu will not be activated.



- To delete the saved digital key (card key), the smart key must be inside the vehicle.
- The deleted digital key (card key) can be re-registered before registering a new digital key (card key).
- If you register a new digital key (card key), the previously registered digital key (card key) cannot be used again.

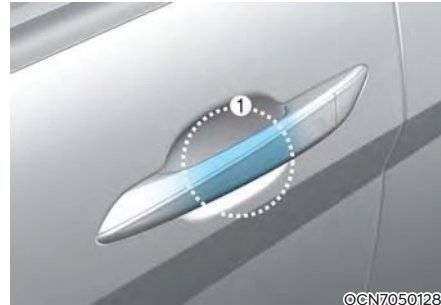

[1] : Door handle authentication pad

#### **NFC door lock/unlock**

You should touch digital key (card key) to door handle authentication pad (1, marked position near by the lock button) of driver's (or front passenger's) outside door for 2 seconds to lock or unlock the doors. If the Two Press Unlock feature is applied (press twice for unlocking), driver's seat door will be unlocked by touching the digital key (card key). In this state, if you touch one more time within 4 seconds, all the doors unlock.

#### *Inoperable condition*

If you do not touch the digital key (card key) to the center of the door handle authentication pad accurately. it may not work. In addition, if you overlap and use the key with NFC-enabled cards such as transportation card or credit card, it may not work.

Note that if you try to lock your vehicle with digital key (card key) in following cases, the doors will not be locked and chime will sound for 3 seconds.

- The Smart Key is in the vehicle.
- The POWER button is in ACC or ON position.
- Any of the doors, hood or trunk are open

If the digital key (card key) does not work, please move the card 4 inches (0.1m) away from the handle authentication pad and retry to touch. If the card key is damaged by impact, it may not operate properly or at all. You should buy a new card and register again. Long-time exposure to high temperature may cause the card key to malfunction. Please be careful not to expose the key to direct sunlight or high temperature.

### Start-up with Card key

After placing your registered card key onto the interior authentication pad (wireless charger), step on the brake and press the Engine Start/Stop button.



### WARNING

- If you do not place the digital key (card key) onto the center of the interior authentication pad (wireless charger) exactly, the card key may not be recognized. If the engine is not turned on, adjust and place the key again.
- If you overlap and use the key with NFC-enabled cards such as transportation card or credit card, the card key may not be recognized.
- If the digital key (card key) does not work, please move the card 4 inches (0.1m) away from the handle authentication pad and retry to touch.
- If the card key is damaged by impact, it may not operate properly or at all. You should buy a new card and register again.

For more information, refer to the Engine Start/Stop button in chapter 6.

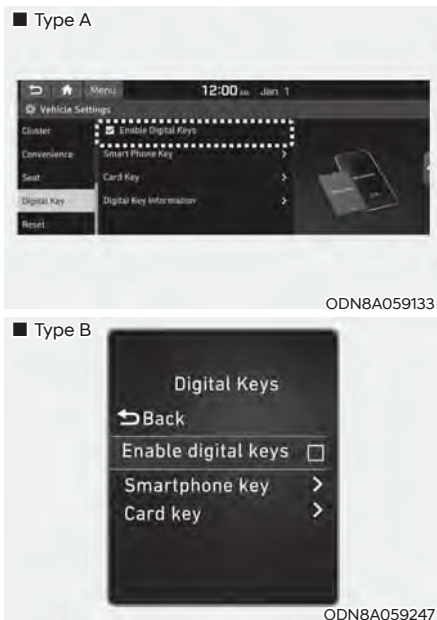

#### Digital key application/cancellation

If you do not want to use the digital key (smartphone and card key), you can disable the function temporarily. You should have the smart key when you change the settings

- \* With Navigation screen :  
From the infotainment screen menu,  
go to [Setup] - [Vehicle] - [Digital Key]  
- [Enable Digital Keys] (deselect)
- \* Without navigation screen :  
From cluster menu, go to [Digital Key]  
- [Enable Digital Keys] (deselect)

#### **i** Information

**If you do not have the smart key in your possession, you cannot deselect [Enable digital keys]. However, if you want to select [Enable digital keys] again, you do not need to have the smart key in your possession.**

#### **⚠** CAUTION

**If you uncheck Enable digital keys, it is impossible to lock or unlock the doors or start up the vehicle with digital keys such as smartphone and card key. If you check Enable digital keys again, the registered digital keys (smartphone and card key) are available. Even though you stop the digital key function, the registered keys (smartphone and card key) are not deleted.**

#### **Personalized profile and vehicle settings**

Connect the registered digital key with personalized profile. Then in case you lock or unlock the door with the digital key NFC function or unlock the door remotely by digital key application Bluetooth connection, the vehicle will play the personalized user profile settings. Profile connection and personalization are available for Driver 1 and Driver 2.

### Profile link/unlinked

#### Profile link

1. Select Setup → User Profile → Profile Settings → Link Digital Key (Smartphone) on the infotainment system menu.
2. Unlock your digital key installed smart phone screen and place it onto the wireless charger according to a message.
3. It begins the profile link with a message.
4. If you select Link, the registered phone number's digital key and the user's profile are linked.
5. The interconnection process is completed with a message.

#### Profile unlink

1. Select Digital Key information on infotainment Vehicle Settings menu. It is possible to unlink only if the profile is interconnected.
2. Profile unlink is completed with a message.

### Information

**If you connect both Driver 1 and Driver 2 with a single smartphone, the smartphone digital key always works as Driver 1.**

**If you unlink the Driver 1, personalization function will operate as Driver 2.**

### *PRECAUTION for vehicle profile link and unlink*

When you link or unlink the profile of digital key, you should be careful of the following.

- Profile link is possible to use with the digital key. (Infotainment Vehicle Settings Mode → Digital Key → Enable Digital Keys)
- Profile link information remains even when you disable the digital key function.
- Only the smart phone with digital key app enables you to link your profile. (Impossible to link with NFC card)
- Profile link works only when the smart phone and the digital key are registered to the vehicle. The smart phone with another vehicle's digital key cannot link profile.
- If you remove the smart phone from the wireless charger before completing the profile link, it does not work.
- To unlink the profile, the smart phone does not need to be on the wireless charger.

**Vehicle personalization operation**

The personalization function linked with digital key works as following conditions:

- Touch the driver's door handle with the profile linked smart phone to lock or unlock the doors (Personalization does not operate when locking or unlocking the front passenger door.)
- Remote door unlock with the profile linked smartphone digital key app.

The profile linked with digital key can be changed manually in the infotainment system setup screen.

**Precaution for digital key profile link and unlink**

Profile operation according to door lock/unlock system is as follows.

Item	Personalization Operation
Initial value	Guest
Profile linked smart phone key	Linked profile
Profile unlinked smart phone key	Recently activated profile
NFC card key	
Smart key	

- The personalization function using the digital key can be operated after linking the digital key on the infotainment system profile menu.
- You should use the personalization function only when the vehicle is safely parked.

**Vehicle personalization with digital key**

The available personalization function in the vehicle is as follows.

System	Personalization Item	
USM	Lamp	Blink number of one-touch signal lamps
	Door	Automatic door lock/unlock, Two Press Unlock
AVN	Navigation	Preferred volume of the navigation system, Recent destination
	User preset	Radio preset
	Bluetooth	Bluetooth preferential connect
Air conditioning (for automatic climate control system)	Operating condition	Latest operation setup of the following functions: Temperature, AUTO, air flow direction, air volume, air conditioner, air intake control, SYNC, Front windshield defroster, OFF

**For more information of personalization, refer to the infotainment system manual.**



**CAUTION**

**If you leave the digital key after locking or unlocking the doors or starting up the vehicle with the smart key, the doors can be locked by the central door lock. Please carry the digital key at all times.**

## DOOR LOCKS

### Operating Door Locks from Outside the Vehicle

#### Mechanical key

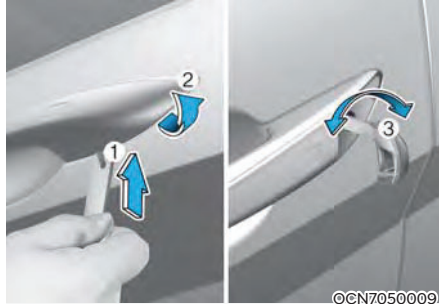

1. Press the lever located under the cover with mechanical key. (1)
2. While pushing the lever so that the mechanical key does not fall out of the cover hole, slowly push it towards the rear of the vehicle and remove the cover. (2)
3. After removing the cover, only driver's door can be locked or unlocked by using mechanical key.
4. Turn the key toward the rear of the vehicle to lock and toward the front of the vehicle to unlock. (3)

If you lock/unlock the driver's door with a key, the driver's door will lock/ unlock automatically.

Once the door is unlocked, it may be opened by pulling the door handle.

Make sure that doors are closed securely.

#### **i** Information

Be careful when locking the door by mechanical key operation, only the driver's door can be locked/unlocked.

Refer to Chapter 5 "Operating door locks from inside the vehicle" to lock from inside the vehicle.

#### **i** Information

When removing the cover, be careful not to lose cover and any scratches.

When the key cover freezes and does not open, lightly tap or indirectly warm(hand temperature, etc.) it.

**Do not apply excessive force to the door and door handle. It may be damaged.**

### Remote key



To lock the doors, press the Door Lock button (1) on the remote key.  
To unlock the doors, press the Door Unlock button (2) on the remote key.  
Once the doors are unlocked, they may be opened by pulling the door handle.  
When closing the door, push the door by hand. Make sure that doors are closed securely.

### Smart key

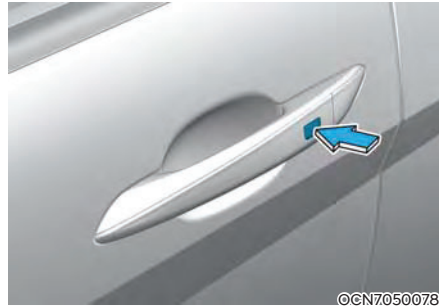

To lock the doors, press the button on the outside door handle while carrying the smart key with you or press the door lock button on the smart key.  
To unlock the doors, press the button on the outside door handle while carrying the smart key with you or press the door unlock button on the smart key.  
Once the doors are unlocked, they may be opened by pulling the door handle.  
When closing the door, push the door by hand. Make sure that doors are closed securely.

### **i** Information

- **In cold and wet climates, door lock and door mechanisms may not work properly due to freezing conditions.**
- **If the door is locked/unlocked multiple times in rapid succession with either the vehicle key or door lock switch, the system may stop operating temporarily in order to protect the circuit and prevent damage to system components.**
- **Two press unlock setting can be changed in the User Settings mode on the cluster.**



## Operating Door Locks from Inside the Vehicle

### With the door handle

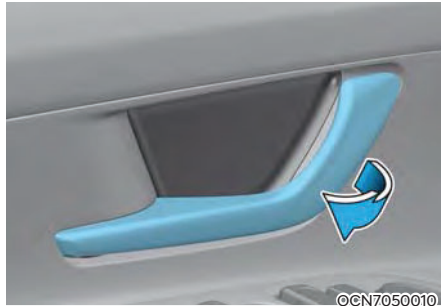

#### Front door

If the inner door handle is pulled when the door is locked, the door will unlock and open.

#### Rear door

If the inner door handle is pulled once when the door is locked, the door will unlock. If the inner door handle is pulled once more, the door will open.

### **i** Information

**If a power door lock ever fails to function while you are in the vehicle try one or more of the following techniques to exit:**

- **Operate the door unlock feature repeatedly (both electronic and manual) while simultaneously pulling on the door handle.**
- **Operate the other door locks and handles, front and rear.**
- **Lower a front window and use the mechanical key to unlock the door from outside.**

### With the central door lock switch



- When pressing the (🔒) portion (1) of the switch, all vehicle doors will lock.
  - If the key is in the ignition switch and any door is opened, the doors will not lock even though the lock button (1) of the central door lock switch is pressed.
  - If the smart key is in the vehicle and any door is opened, the doors will not lock even though the lock button (1) of the central door lock switch is pressed.
- When pressing the (🔓) portion (2) of the switch, all vehicle doors will unlock.
- Doors indicating light (3)
  - When all vehicle doors are locked, the indicating lights on the driver's door and passenger's door will turn on. If any door is unlocked, it would go off.

 **WARNING**

- The doors should always be fully closed and locked while the vehicle is in motion. If the doors are unlocked, the risk of being thrown from the vehicle in a crash is increased.
- Do not pull the inner door handle of the driver's or passenger's door while the vehicle is moving.

 **WARNING**

Do not leave children or animals unattended in your vehicle. An enclosed vehicle can become extremely hot, causing death or serious injury to unattended children or animals who cannot escape the vehicle.

Children might operate features of the vehicle that could injure them, or they could encounter other harm, possibly from someone gaining entry to the vehicle.

 **WARNING**

Always secure your vehicle.

Leaving your vehicle unlocked increases the potential risk to you or others from someone hiding in your vehicle.

To secure your vehicle, while depressing the brake, move the shift button to the P (Park) position, engage the parking brake, and place the ignition switch in the LOCK/OFF position, close all windows, lock all doors, and always take the key with you.

 **WARNING**

If you stay in the vehicle for a long time while the weather is very hot or cold, there are risks of injuries or danger to life. Do not lock the vehicle from the outside when someone is in the vehicle.

 **WARNING**

Opening a door when something is approaching may cause damage or injury. Be careful when opening doors and watch for vehicles, motorcycles, bicycles or pedestrians approaching the vehicle in the path of the door.

## Automatic Door Lock and Unlock Features

### ***Impact sensing door unlock system (if equipped)***

All doors will be automatically unlocked when an impact causes the air bags to deploy.

### ***Speed sensing door lock system (if equipped)***

All doors will be automatically locked when vehicle speed exceeds 9 mph (15 km/h).

You can activate or deactivate the Auto Door Lock/Unlock features from the User Settings Mode on the LCD display.

**For more details, refer to “LCD Display” in chapter 4. If your vehicle is equipped with additional navigation, please refer to the infotainment system manual separately supplied.**

## Child-Protector Rear Door Locks



The child safety lock is provided to help prevent children seated in the rear from accidentally opening the rear doors.

The rear door safety locks should be used whenever children are in the vehicle.

The child safety lock is located on the edge of each rear door. When the child safety lock is in the lock position, the rear door will not open if the inner door handle is pulled.

To lock the child safety lock, insert a key (or screwdriver) (1) into the hole and turn it to the lock position.

To allow a rear door to be opened from inside the vehicle, unlock the child safety lock.

### **WARNING**

**If children accidentally open the rear doors while the vehicle is in motion, they could fall out of the vehicle. The rear door safety locks should always be used whenever children are in the vehicle.**

### Rear Occupant Alert (ROA) System

This function helps prevent the driver from leaving a passenger in the rear seats.

**If your vehicle is equipped with additional navigation, please refer to the infotainment system manual separately supplied.**

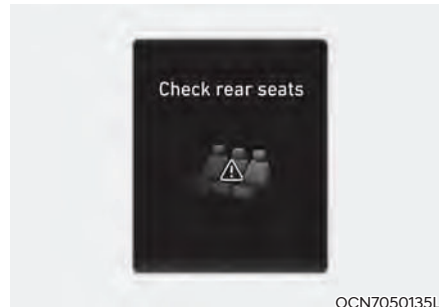

#### **NOTICE**

When the driver turns off the engine and opens the driver's door after opening and closing a rear door, a warning message "Check rear seats" appears.



#### **WARNING**

The rear seat passenger alarm system provides information to the driver to check the rear seats but it does not detect whether there is an object or passenger in the back seats. Please check the rear seats always when leaving the vehicle.



#### **CAUTION**

The door open and close history is initialized if the driver turns off the engine and lock the vehicle door. Even though the rear door is not opened again, the alarm may sound if there is the previous record. For example, if the driver does not lock the vehicle door and opens the door to get off after the alarm sounds, the alarm may go off.

## THEFT-ALARM SYSTEM

This system helps to protect your vehicle and valuables. The horn will sound and the hazard warning lights will blink continuously if any of the following occur:

- A door is opened without using the remote key or smart key.
- The trunk is opened without using the remote key or smart key.
- The engine hood is opened.

The alarm continues for 30 seconds, then the system resets. To turn off the alarm, unlock the doors with the remote key or smart key.

The Theft Alarm System automatically sets 30 seconds after you lock the doors and the trunk. For the system to activate, you must lock the doors and the trunk from outside the vehicle with the remote key or smart key or by pressing the button on the outside of the door handle with the smart key in your possession.

The hazard warning lights will blink and the chime will sound once to indicate the system is armed.

Once the security system is set, opening any door, the trunk, or the hood without using the remote key or smart key will cause the alarm to activate.

The Theft Alarm System will not set if the hood, the trunk, or any door is not fully closed. If the system will not set, check the hood, the trunk, or the doors are fully closed.

Do not attempt to alter this system or add other devices to it.

### **i** Information

- **Do not lock the doors until all passengers have left the vehicle. If the remaining passenger leaves the vehicle when the system is armed, the alarm will be activated.**
- **If the vehicle is not disarmed with the remote key or smart key, open the doors by using the mechanical key and place the ignition switch in the ON position (for remote key) or start the engine (for smart key) and wait for 30 seconds.**
- **When the system is disarmed but a door or trunk is not opened within 30 seconds, the system will be rearmed.**

## STEERING WHEEL

### Electric Power Steering (EPS)

The system assists you with steering the vehicle. If the vehicle is turned off or if the power steering system becomes inoperative, you may still steer the vehicle, but it will require increased steering effort.

Also, the steering effort becomes heavier as the vehicle's speed increases and becomes lighter as the vehicle's speed decreases for better control of the steering wheel.

Should you notice any change in the effort required to steer during normal vehicle operation, have the system checked by an authorized HYUNDAI dealer.



### CAUTION

- If the Electric Power Steering System does not operate normally, the warning light (⚠) will illuminate on the instrument cluster. You may steer the vehicle, but it will require increased steering efforts. Take your vehicle to an authorized HYUNDAI dealer and have the system checked as soon as possible.
- When an abnormality is detected in the electric power steering system, to prevent an accident, the steering assist function may become inoperative. At this time, the warning light turns on or blinks on the cluster. The steering wheel may become difficult to control or operate. Have your vehicle checked immediately, after moving the vehicle to a safe area.

### Information

The following symptoms may occur during normal vehicle operation:

- The steering effort may be high immediately after placing the ignition switch in the ON position.  
**This happens as the system performs the EPS system diagnostics. When the diagnostics are completed, the steering wheel effort will return to its normal condition.**
- When the battery voltage is low, you may have to put more steering effort. However, it is a temporary condition so that it will return to normal condition after charging the battery.
- A click noise may be heard from the EPS relay after the ignition switch is in the ON or LOCK/OFF position.
- Motor noise may be heard when the vehicle is at a stop or at a low driving speed.
- When you operate the steering wheel in low temperatures, abnormal noise may occur. If the temperature rises, the noise will disappear. This is a normal condition.
- When an error is detected from the EPS, the steering effort assist function may become inoperative in order to prevent fatal accidents. Instrument cluster warning lights may be on or the steering effort may be high. If these symptoms occur, drive the vehicle to a safe area as soon as it is safe to do so. Have the system checked by an authorized HYUNDAI dealer as soon as possible.

### Tilt Steering / Telescope Steering

When adjusting the steering wheel to a comfortable position, adjust the steering wheel so that it points toward your chest, not toward your face. Make sure you can see the instrument cluster warning lights and gauges. After locking the lever, push the steering wheel both up and down to be certain it is locked in position. Always adjust the position of the steering wheel before driving.



#### **WARNING**

**NEVER** adjust the steering wheel while driving. This may cause loss of vehicle control resulting in an accident.



To adjust the steering wheel angle and height:

1. Pull down the lock-release lever (1).
2. Adjust the steering wheel to the desired angle (2) and distance forward/back (3).
3. Pull up the lock-release lever to lock the steering wheel in place.



#### **Information**

Sometimes the lock release lever may not engage completely. This may occur when the gears of the locking mechanism do not completely mesh. If this occurs, pull down on the lock release lever, readjust the steering wheel again, and then pull back up on the release lever to lock the steering wheel in place.



#### **CAUTION**

While adjusting the steering wheel height, please do not push or pull it hard since the fixture can be damaged.

## Horn

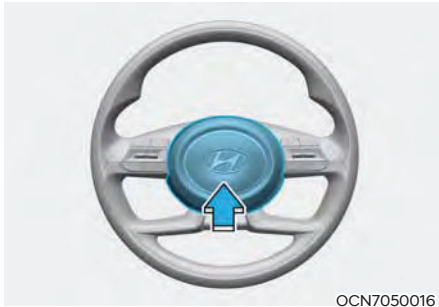

OCN7050016

To sound the horn, press the area indicated by the horn symbol on your steering wheel (see illustration). The horn will operate only when this area is pressed.

### **NOTICE**

**Do not strike the horn severely to operate it, or hit it with your fist. Do not press on the horn with a sharp-pointed object.**



## MIRRORS

### Inside Rearview Mirror

Before driving your vehicle, check to see that your inside rearview mirror is properly positioned. Adjust the rearview mirror so that the view through the rear window is properly centered.



#### WARNING

Make sure your line of sight is not obstructed. Do not place objects in the rear seat, cargo area, or behind the rear head restraints which could interfere with your vision through the rear window.



#### WARNING

To prevent serious injury during an accident or deployment of the air bag, do not modify the rearview mirror and do not install a wide mirror.



#### WARNING

NEVER adjust the mirror while driving. This may cause loss of vehicle control resulting in an accident.

#### NOTICE

When cleaning the mirror, use a paper towel or similar material dampened with glass cleaner. Do not spray glass cleaner directly on the mirror as this may cause the liquid cleaner to enter the mirror housing.

### Day/night rearview mirror (if equipped)

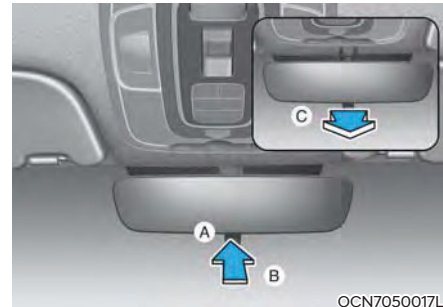

[A] : Lever, [B] : Day, [C] : Night

Make this adjustment before you start driving and while the day/night lever is in the day position.

Pull the day/night lever towards you to reduce glare from the headlamps of the vehicles behind you during night driving.

*Remember that you lose some rearview clarity in the night position.*

**Electrochromic mirror (ECM) with HomeLink® system (if equipped)**

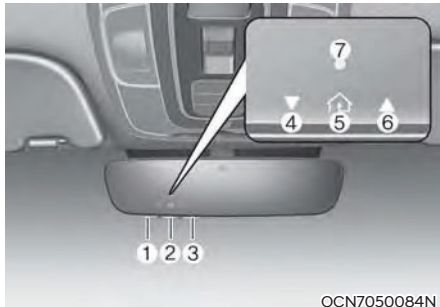

Your vehicle may be equipped with a Gentex Automatic-Dimming Mirror with an Integrated HomeLink® Wireless Control System.

During nighttime driving, this feature will automatically detect and help reduce rearview mirror glare. The HomeLink® Universal Transceiver allows you to activate your garage door(s), electric gate, home lighting, etc.

- (1) HomeLink Channel 1
- (2) HomeLink Channel 2
- (3) HomeLink Channel 3
- (4) Garage Door Opener Status Indicator : Closing or Closed
- (5) HomeLink Operation Indicator
- (6) Garage Door Opener Status Indicator : Opening or Opened
- (7) HomeLink User Interface Indicator

**Automatic-Dimming Night Vision Safety™ (NVS®) Mirror (if equipped)**

The NVS® Mirror automatically helps reduce glare by monitoring light levels in the front and the rear of the vehicle. Any object that obstructs either light sensor will degrade the automatic dimming control feature.

**For more information regarding NVS® mirrors and other applications, please refer to the Gentex website:**

**[www.gentex.com](http://www.gentex.com)**

Your mirror will automatically dim upon detecting glare from the vehicles traveling behind you.

The mirror defaults to the ON position each time the vehicle is started.

**Integrated HomeLink® Wireless Control System**

The HomeLink® Wireless Control System can replace up to three hand-held radio-frequency (RF) transmitters with a single built-in device. This innovative feature will learn the radio frequency codes of most current transmitters to operate devices such as gate operators, garage door openers, entry door locks, security systems, even home lighting. Both standard and rolling code-equipped transmitters can be programmed by following the outlined procedures.

Additional HomeLink® information can be found at: [www.homelink.com](http://www.homelink.com), [www.youtube.com/HomeLinkGentex](http://www.youtube.com/HomeLinkGentex) or by calling 1-800-355-3515.

Retain the original transmitter of the RF device you are programming for use in other vehicles as well as for future HomeLink® programming. It is also suggested that upon the sale of the vehicle, the programmed HomeLink® buttons be erased for security purposes.

**WARNING**

Before programming HomeLink® to a garage door opener or gate operator, make sure people and objects are out of the way of the device to prevent potential harm or damage. Do not use the HomeLink® with any garage door opener that lacks the safety stop and reverse features required by U.S. federal safety standards (this includes any garage door opener model manufactured before April 1, 1982). A garage door that cannot detect an object - signaling the door to stop and reverse - does not meet current U.S. federal safety standards. Using a garage door opener without these features increases the risk of serious injury or death.

**Programming HomeLink®**

Please note the following:

- When programming a garage door opener, it is advised to park the vehicle outside of the garage.
- It is recommended that a new battery be placed in the hand-held transmitter of the device being programmed to HomeLink® for quicker training and accurate transmission of the radio-frequency signal.
- Some vehicles may require the Engine Start/Stop button to be in the ACC (or "Accessories") position for programming and/or operation of HomeLink®.
- In the event that there are still programming difficulties or questions after following the programming steps listed below, contact HomeLink® at: [www.homelink.com](http://www.homelink.com), [www.youtube.com/HomeLinkGentex](http://www.youtube.com/HomeLinkGentex) or by calling 1-800-355-3515.

**Programming**

To program most devices, follow these instructions:



OCN7050085N

1. Press and release (1), (2) or (3) button.
  - If the indicator (4) is turned ON in Orange, go to Step 3) since it is a new programming.
  - If the indicator (4) is continuously turned ON or flashes in Green rapidly several times, go to Step 2) since it is a programmed button.
2. Press and hold the button you wish to program for approximately 15-25 seconds until the LED flashes in Orange for several times.
3. Hold the Garage Door Opener Original Transmitter near the HomeLink Mirror.



OCN7050086N

4. Press the Original Transmitter button until the indicator (4) is turned continuously ON or flashes in Green for approximately 10 seconds and it indicates the programming is completed.
5. However, the indicator (4) flashes in Green continuously, but if the garage door opener does not operate, please continue to follow the step 6 and 7 (“Rolling Code Programming” procedures).
6. Firmly press and release the “Learn,” “Smart,” or “Program” button while the indicator (4) flashes in Green. Once the button is pressed, you have approximately 30 seconds to initiate the next step.
7. Return to the vehicle and firmly press, hold for two seconds and release the HomeLink button up to three times. Do not press the HomeLink button rapidly. At this point programming is complete and your device should operate when the HomeLink button is pressed and released.

### **i** Information

- **Some garage door openers require to press the programmed button on the mirror up to three times right after the programming is just completed to operate the garage door.**
- **The indicator (4) is turned ON in Orange and flashes for about 60 seconds, during the programming mode and if a programming is not succeeded within the 60 seconds, the programming mode will be abort.**

HomeLink® should now activate your rolling code equipped device.

### **i** Information

**At the garage door opener motor, (security gate motor, etc.) locate the “Learn,” “Smart,” or “Program” button. This can usually be found where the hanging antenna wire is attached to the motor-head unit (see the device’s manual to identify this button). The name and color of the button may vary by manufacturer. A ladder and/or second person may simplify the following steps.**

*Gate operator & Canadian programming*

During programming, your handheld transmitter may automatically stop transmitting. Continue to press the Integrated HomeLink® Wireless Control System button while you press and re-press (“cycle”) your handheld transmitter every two seconds until the frequency signal has been learned. The indicator light will flash slowly and then rapidly after several seconds upon successful training.

*Operating HomeLink®*

1. Press and release one of the HomeLink buttons (1, 2 or 3) that programmed.
2. The HomeLink indicator (4) will operate as below:
  - Indicates Green and is continuously ON (Fixed Code Garage Door Opener)
  - Flashes in Green rapidly (Rolling Code Garage Door Opener)

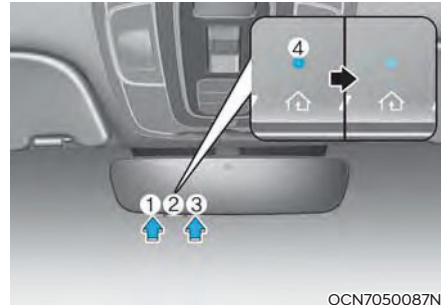
*Erasing HomeLink® buttons*

1. Press and hold the button (1) and (3) simultaneously.
2. The indicator (4) is turned continuously ON in orange for about 10 seconds.
3. Then the indicator (4) color changes to Green and flashes rapidly. Release the buttons once the green indicator flashes.
4. Now HomeLink button (1), (2) and (4) memories are all cleared.

NVS® is a registered trademark and Z-Nav™ is a trademark of the Gentex Corporation, Zeeland, Michigan. HomeLink® is a registered trademark owned by Johnson Controls, Incorporated, Milwaukee, Wisconsin.

**FCC ID: NZLUAHL5A**

**IC: 4112A-UAHL5A**

**i** Information

This device complies with Part 15 of the FCC Rules.

Operation is subject to the following three conditions:

1. This device may not cause harmful interference, and
2. This device must accept any interference received, including interference that may cause undesired operation.
3. The transceiver has been tested and complies with FCC and Industry Canada rules. Changes or modifications not expressly approved by the party responsible for compliance could void the user's authority to operate the device.

*Two Way Communication Programming*

1. Complete the HomeLink "Programming" first.
2. Before the first 10 times HomeLink button is pressed after the programming, the following steps MUST occur to program two way communication. (only for some older garage doors)



3. Press and release the programmed HomeLink button to activate the garage door.
4. Once the garage door is stopped, press and release the "Learn" or "Smart" button on the Garage door opener within 1 minute from the time of pressing the programmed HomeLink button on mirror.

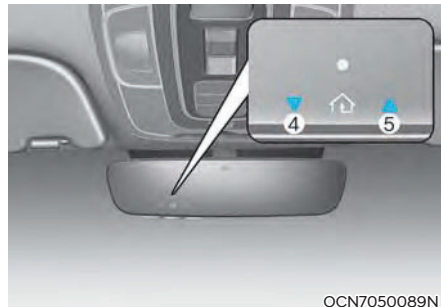

5. If the both indicator (4) and (5) are flashing rapidly for about 5 seconds, the two way synchronization is completed.

**i** Information

Some newer garage door openers provide two-way communication synchronizing when programing the original transmitter.



*Operating Two Way Communication*

1. Press and release (1), (2) or (3) button.



2. The indicator (4) and (5) operates as below:
- If the indicator (4) flashes in Orange, it indicates that the garage door is "closing".
  - If the indicator (4) is ON continuously in Green, it indicates that the garage door is "closed".
  - If the indicator (5) flashes in Orange, it indicates that the garage door is "Opening".
  - If the indicator (5) is ON continuously in Green, it indicates that the garage door is "Opened".
  - If the indicator (4) or (5) does not turn to Green, it indicates that the last status of garage door was not received properly. The HomeLink mirror tries to receive the last known status of the garage door for a few seconds.

### *Recalling Garage Door Status*

Homelink mirror with two way communication provides a way to view the last stored message from the garage door opener. In order to recall the last known status of the last activated device, press the buttons "1 and 2" OR "2 and 3" simultaneously.

- If the indicator (4) is ON continuously in Green, it indicates that the last activated device was "closed" properly.
- If the indicator (5) is ON continuously in Green, it indicates that the last activated device was "open" properly.

### **i** Information

**Two way communication range distance between "vehicle" and "garage door opener" is 100m.**

**The range may be reduced or increased a little due to obstacle conditions around the garage door opener, such as houses or trees.**



### Side View Mirrors



Make sure to adjust the side view mirrors to your desired position before you begin driving.

Your vehicle is equipped with both left-hand and right-hand side view mirrors. The mirrors can be adjusted remotely with the remote switch. The side view mirrors can be folded to help prevent damage when going through an automatic car wash or when passing through a narrow street.

The right side view mirror is convex. Objects seen in the mirror are closer than they appear.

Use the inside rear view mirror or look back directly to determine the actual distance of other vehicles prior to changing lanes.

### **WARNING**

Do not adjust or fold the side view mirrors while driving. This may cause loss of vehicle control resulting in an accident.

### **NOTICE**

- Do not scrape ice off the mirror face; this may damage the surface of the glass.
- If the mirror is jammed with ice, do not adjust the mirror by force. Use an approved spray de-icer (not radiator antifreeze) spray, or a sponge or soft cloth with very warm water, or move the vehicle to a warm place and allow the ice to melt.

### Side View Mirror Adjustment

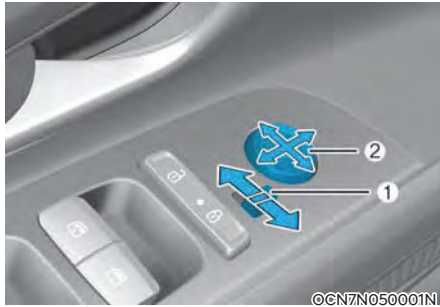

1. Press either the L (left side) or R (right side) button (1) to select the side view mirror you would like to adjust.
2. Use the mirror adjustment control (2) to position the selected mirror up, down, left or right.
3. After adjustment, put the button into neutral (center) position to prevent inadvertent adjustment.

#### **NOTICE**

- **The mirrors stop moving when they reach the maximum adjusting angles, but the motor continues to operate while the switch is pressed. Do not press the switch longer than necessary, because this can damage the motor.**
- **Do not attempt to adjust the side view mirrors by hand, because this can damage the motor.**

### Folding the side view mirrors



To fold the side view mirrors, grasp the housing of the mirror and then fold it inwards.

## WINDOWS

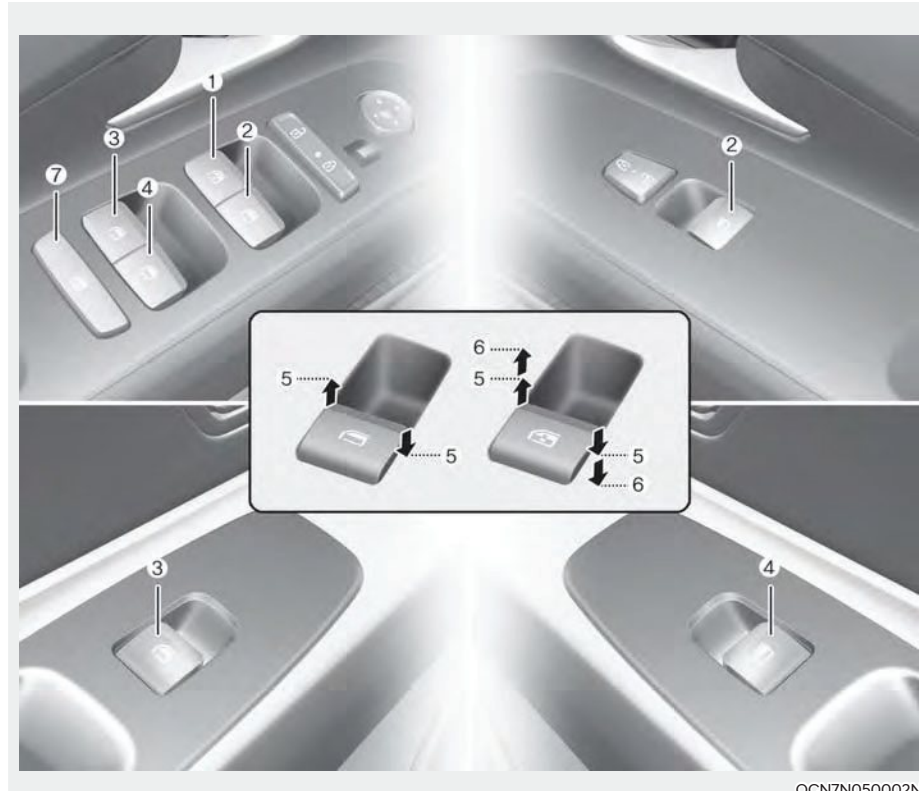

OCN7N050002N

- |  |                                |
|--|--------------------------------|
| (1) Driver's door power window switch          | (5) Window opening and closing |
| (2) Front passenger's door power window switch | (6) Automatic power window     |
| (3) Rear door (left) power window switch       | (7) Power window lock switch   |
| (4) Rear door (right) power window switch      |                                |

## Power Windows

The ignition switch must be in the ON position to be able to raise or lower the windows. Each door has a Power Window switch to control that door's window. The driver has a Power Window Lock switch which can block the operation of passenger windows. The power windows will operate for approximately 30 seconds after the ignition switch is placed in the ACC or LOCK/OFF position. However, if the front doors are opened, the Power Windows will not operate even within the 30 second period.



### WARNING

To avoid serious injury or death, do not extend your head, arms or body outside the windows while driving.



### Information

- In cold and wet climates, power windows may not work properly due to freezing conditions.
- While driving with the rear windows down or with the sunroof (if equipped) opened (or partially opened), your vehicle may demonstrate a wind buffeting or pulsation noise. This noise is normal and can be reduced or eliminated by taking the following actions. If the noise occurs with one or both of the rear windows down, partially lower both front windows approximately one inch. If you experience the noise with the sunroof open, slightly close the sunroof.

## Window opening and closing



To open:

Press the window switch down to the first detent position (5). Release the switch when you want the window to stop.

To close:

Pull the window switch up to the first detent position (5). Release the window switch when you want the window to stop.

### **Auto down window (if equipped)**

Pressing the power window switch down momentarily to the second detent position (6) completely lowers the window even when the switch is released. To stop the window at the desired position while the window is in operation, pull up or press down and release the switch.

### **Auto up/down window (if equipped)**

Pressing or pulling up the power window switch momentarily to the second detent position (6) completely lowers or lifts the window even when the switch is released. To stop the window at the desired position while the window is in operation, pull up or press down and release the switch.

**To reset the power windows**

If the power windows do not operate normally, the automatic power window system must be reset as follows:

1. Place the ignition switch to the ON position.
2. Close the window and continue pulling up on the power window switch for at least one second.

If the power windows do not operate properly after resetting, have the system checked by an authorized HYUNDAI dealer.

**WARNING**

**The automatic reverse feature doesn't activate while resetting the power window system. Make sure body parts or other objects are safely out of the way before closing the windows to avoid injuries or vehicle damage.**

**Automatic reverse (if equipped)**

If a window senses any obstacle while it is closing automatically, it will stop and lower approximately 12 inches (30 cm) to allow the object to be cleared.

If the window detects the resistance while the power window switch is pulled up continuously, the window will stop upward movement then lower approximately 1 inch (2.5 cm).

If the power window switch is pulled up continuously again within 5 seconds after the window is lowered by the automatic window reverse feature, the automatic window reverse will not operate.

**Information**

**The automatic reverse feature is only active when the “Auto Up” feature is used by fully pulling up the switch to the second detent.**

**WARNING**

**Make sure body parts or other objects are safely out of the way before closing the windows to avoid injuries or vehicle damage.**

**Objects less than 0.16 inch (4 mm) in diameter caught between the window glass and the upper window channel may not be detected by the automatic reverse window and the window will not stop and reverse direction.**

**NOTICE**

Do not install any accessories on the windows. The automatic reverse feature may not operate.

**Power window lock switch**



The driver can disable the power window switches on the rear passenger doors by pressing the power window lock switch.

When the power window lock switch is pressed:

- The rear passenger control will not be able to operate the rear passenger power window
- Note that the front passenger control is still able to operate the front passenger window, and that the driver master control can still operate all the power windows.

**NOTICE**

- To prevent possible damage to the power window system, do not open or close two windows or more at the same time. This will also ensure the longevity of the fuse.
- Never try to operate the main switch on the driver's door and the individual door window switch in opposite directions at the same time. If this is done, the window will stop and cannot be opened or closed.



**WARNING**

- NEVER leave the keys in your vehicle with unsupervised children, when the engine is running.
- NEVER leave any child unattended in the vehicle. Even very young children may inadvertently cause the vehicle to move, entangle themselves in the windows, or otherwise injure themselves or others.
- Always double check to make sure arms, hands, head and other obstructions are safely out of the way before closing a window.
- Do not allow children to play with the power windows. Keep the driver's door power window lock switch in the LOCK position (pressed). Serious injury can result from unintentional window operation by the child.
- Do not extend your head, arms or body outside the windows while driving.

## SUNROOF (IF EQUIPPED)



If your vehicle is equipped with a sunroof, you can slide or tilt your sunroof with the sunroof control switch located on the overhead console.

The sunroof can only be opened, closed, or tilted when the ignition switch is in the ON position.

The sunroof can be operated for approximately 3 minutes after the ignition switch is turned to the ACC or OFF position.

However, if the front door is opened, the sunroof cannot be operated even within the 3 minutes period.

### **i** Information

- In cold and wet climates, the sunroof may not work properly due to freezing conditions.
- After the vehicle is washed or in a rainstorm, be sure to wipe off any water that is on the sunroof before operating it.

### **⚠** WARNING

- Never adjust the sunroof or sunshade while driving. This could result in loss of control and an accident that may cause death, serious injury, or property damage.
- Make sure heads, other body parts or objects are out of the way before using the sunroof.
- Do not extend your head, arms or body outside the sunroof while driving, to avoid serious injury.
- Do not leave the engine running and the key in your vehicle with unsupervised children. Unattended children could operate the sunroof, which could result in serious injury.
- Do not sit on the top of the vehicle. It may cause injuries or vehicle damage.

### **NOTICE**

- Do not continue to move the sunroof control lever after the sunroof is fully opened, closed, or tilted. Damage to the motor or system components could occur.
- Make sure the sunroof is closed fully when leaving your vehicle. If the sunroof is open, rain or snow may leak through the sunroof and wet the interior as well as allow theft.

### Sunroof opening and closing



To open or close the sunroof (manual slide feature), push the sunroof control lever backward or forward to the first detent position.

To open the sunroof (auto slide feature), push the sunroof control lever backward to the second detent position.

The sunroof will slide to the recommended open position before the maximum slide open position.

To stop the sunroof sliding at any point, push the sunroof control lever momentarily.

To open the sunroof to the maximum slide open position, press the lever towards the rear of the vehicle once again and hold it until the sunroof slide all the way open.

#### **i** Information

To reduce wind noise while driving, we recommend you to drive at the recommended position before the maximum slide open position.

### Automatic reverse (if equipped)

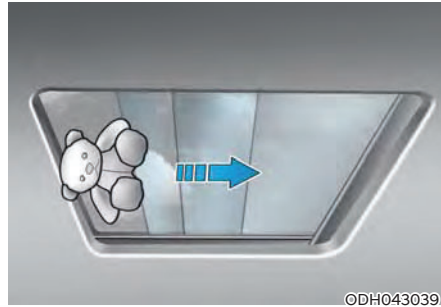

If an object or part of the body is detected while the sunroof glass is closing automatically, it will reverse the direction, and then stop.

The auto reverse function does not work if a tiny obstacle is between the sliding glass and the sunroof sash. You should always check that all passengers and objects are away from the sunroof before closing it.

#### **!** WARNING

Small objects that can get caught between the sliding glass and the sunroof sash may not be detected by the automatic reverse system. In this case, the sunroof glass will not detect the object and will not reverse direction.



### Tilting the sunroof

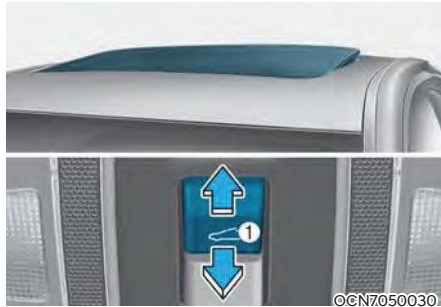

Tilt the sunroof open:

Push the sunroof control lever upward until the sunroof moves to the desired position.

To close the sunroof:

Press the sunroof lever forward until the sunroof moves to the desired position.

#### **NOTICE**

- Periodically remove any dirt that may accumulate on the sunroof guide rail or between the sunroof and roof panel, which can make a noise.
- Do not try to open the sunroof when the temperature is below freezing or when the sunroof is covered with snow or ice, otherwise the motor could be damaged. In cold and wet climates, the sunroof may not work properly.

### Sunshade



The sunshade will open automatically with the sunroof when the glass panel moves. If you want it closed, move the sunshade manually.

#### **NOTICE**

**The sunroof is made to slide together with the sunshade. Do not leave the sunshade closed while the sunroof is open.**

### Resetting the sunroof

The sunroof may need to be reset if the following conditions occur:

- The battery is discharged or disconnected or the sunroof fuse has been replaced or disconnected.
  - The sunroof control lever is not operating correctly.
1. Turn the ignition switch to the ON position or start the engine. We recommend resetting the sunroof while the engine is running.
  2. Close the sunroof completely if opened.
  3. Release the sunroof control lever.
  4. Move the sunroof control lever forward in the direction of close until the sunroof moves tilt up. Then, release the lever.
  5. Move the sunroof control lever forward in the direction of close, until the sunroof operates as follow again:  
Tilt down → Slide Open → Slide Close

#### **NOTICE**

**Do not release the lever until the operation is completed. If you release the lever during operation, try again from step 2.**

6. Release the sunroof control lever after all operation has completed. (The sunroof system has been reset.)

#### **i Information**

- **If the sunroof does not reset when the vehicle battery is disconnected or discharged, or related fuse is blown, the sunroof may not operate normally.**
- **For more detailed information, we recommend that you contact an authorized HYUNDAI dealer.**

### Sunroof open warning (if equipped)

- If the driver removes the ignition key (smart key : turns off the engine) when the sunroof is not fully closed, the warning chime will sound for a few seconds and a warning image will appear in the LCD window.

Close the sunroof securely when leaving your vehicle.



OCN7040018

## HOOD

### Opening the hood

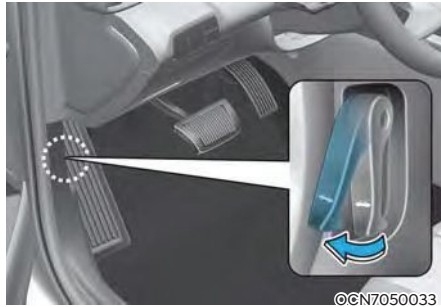

1. Park the vehicle and set the parking brake.
2. Pull the release lever to unlatch the hood. The hood should pop open slightly.

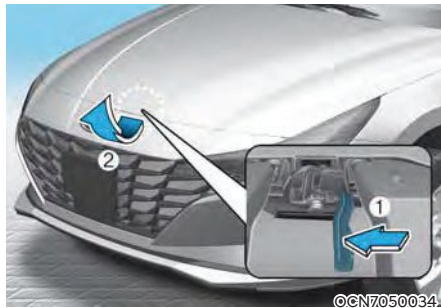

3. Go to the front of the vehicle, raise the hood slightly, push the secondary latch up (1) inside of the hood center and lift the hood (2).
4. Pull out the support rod.



5. Hold the hood open with the support rod (3).

### **WARNING**

#### Support rod

- After driving, the engine compartment and support rod will be hot. Grasp the support rod in the area wrapped in rubber to prevent burns.
- The support rod must be inserted completely into the hole provided whenever you inspect the engine compartment. This will prevent the hood from falling and possibly injuring you.

### **Closing the hood**

1. Before closing the hood, check the following:
  - All filler caps in engine compartment must be correctly installed.
  - Gloves, rags or any other combustible material must be removed from the engine compartment.
2. Return the support rod to its clip to prevent it from rattling.
3. Lower the hood halfway (lifted approximately 30 cm from the closed position) and push down to securely lock in place. Then double check to be sure the hood is secure.

If the hood can be raised slightly, it is not securely locked. Open it again and close it with more force.



### **WARNING**

- **Before closing the hood, ensure all obstructions are removed from around the hood opening.**
- **Always double check to be sure that the hood is firmly latched before driving away. Check there is no hood open warning light or message displayed on the instrument cluster. Driving with the hood opened may cause a total loss of visibility, which might result in an accident.**
- **Do not move the vehicle with the hood in the raised position, as vision is obstructed, which might result in an accident, and the hood could fall or be damaged.**

## TRUNK

### Opening the trunk

1. Make sure the shift lever is in P (Park, for Dual clutch transmission/ Intelligent variable transmission) or first gear or R (Reverse, for manual transmission) and set the parking brake.



2. Then do one of the following:
  - Hold down the trunk unlock button located on your remote key or smart key for more than 1 second.
  - Additionally, for vehicles equipped with smart key :
    - While all doors are unlocked, press the switch in the trunk to open the trunk with or without the smart key in your possession.
    - If any door is locked or all doors are locked, the switch can still be used to open the trunk, as long as the smart key is in your possession.



- Use the trunk release lever.
3. Lift the trunk lid up.

### Closing the trunk

Lower the trunk lid and press down until it locks. To be sure the trunk lid is securely fastened, always check by trying to pull it up again.

#### **WARNING**

**Always keep the trunk lid completely closed while the vehicle is in motion. If it is left open or ajar, poisonous exhaust gases containing carbon monoxide (CO) may enter the vehicle and serious illness or death may result.**

#### **Information**

**To prevent damage to the trunk lift cylinders and the attached hardware, always close the trunk before driving.**

#### **NOTICE**

**In cold and wet climates, trunk lock and trunk mechanisms may not work properly due to freezing conditions.**

### Emergency trunk safety release



Your vehicle is equipped with an Emergency Trunk Safety Release lever located inside the trunk. When someone is inadvertently locked in the trunk, the trunk can be opened by moving the lever in the direction of the arrow and pushing the trunk open.

### WARNING

- You and your passengers must be aware of the location of the Emergency Trunk Safety Release lever in this vehicle and how to open the trunk in case you are accidentally locked in the trunk.
- NEVER allow anyone to occupy the trunk of the vehicle at any time. If the trunk is partially or totally latched and the person is unable to get out, serious injury or death could occur due to lack of ventilation, exhaust fumes and rapid heat build-up, or because of exposure to cold weather conditions. The trunk is also a highly dangerous location in the event of a crash because it is not a protected occupant space but is a part of the vehicle's crush zone.
- Your vehicle should be kept locked and the Smart Key should be kept out of the reach of children. Parents should teach their children about the dangers of playing in trunks.
- Use the release lever for emergencies only.

### Smart Trunk release (if equipped)

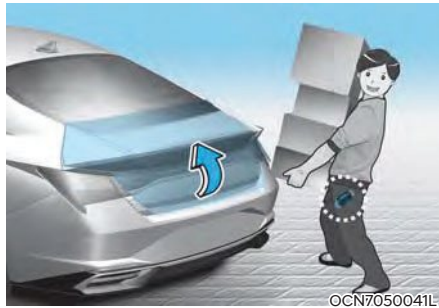

On a vehicle equipped with a smart key, the trunk can be opened using the Smart Trunk release system.

#### How to use the Smart Trunk release

The trunk can be opened with no touch activation satisfying all the conditions below.

- After 15 seconds when all doors are closed and locked
- Positioned in the detecting area for more than 3 seconds

#### **i** Information

The Smart Trunk release does not operate when:

- The smart key is detected within 15 seconds after the doors are closed and locked, and is continuously detected.
- The smart key is detected within 15 seconds after the doors are closed and locked, and 1.5 m from the front door handles. (for vehicles equipped with Welcome Light)
- A door is not locked or closed.
- The smart key is in the vehicle.

#### 1. Setting

To activate the Smart Trunk release, go to User Settings Mode and select Smart Trunk on the LCD display.

**For more details, refer to “LCD Display” in this chapter. If your vehicle is equipped with additional navigation, please refer to the infotainment system manual separately supplied.**



#### 2. Detect and Alert

If you are positioned in the detecting area (20 ~ 40 inches behind the vehicle) carrying a smart key, the hazard warning lights will blink and chime will sound to alert you the smart key has been detected and the trunk will open.

#### **i** Information

**Do not approach the detecting area if you do not want the trunk to open. If you have unintentionally entered the detecting area and the hazard warning lights and chime starts to operate, leave the detecting area with the smart key. The trunk will stay closed.**

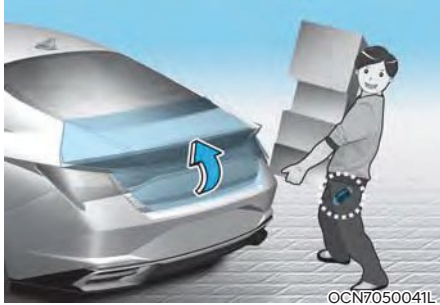

3. Automatic opening

The hazard warning lights will blink and chime will sound 6 times and then the trunk will open.

**WARNING**

- Make sure you close the trunk before driving your vehicle.
- Make sure there are no people or objects around the trunk before opening or closing the trunk.
- Make sure objects in the trunk do not come out when opening the trunk on a slope. It may cause serious injury.
- Make sure to deactivate the Smart Trunk when washing your vehicle. Otherwise, the trunk may open inadvertently.
- The key should be kept out of reach of children. Children may inadvertently open the Smart Trunk release while playing around the rear area of the vehicle.

**How to deactivate the Smart Trunk release function using the smart key**

■ Type A



OCN7050004

■ Type B



OCN7050005

1. Door lock
2. Door unlock
3. Trunk open
4. Panic
5. Remote Start (if equipped)

If you press any button of the smart key during the Detect and Alert stage, the Smart Trunk release function will be deactivated.

Make sure to be aware of how to deactivate the Smart Trunk release function for emergency situations.



### **i** Information

- If you press the door unlock button (2), the Smart Trunk release function will be deactivated temporarily. But, if you do not open any door for 30 seconds, the smart trunk function will be activated again.
- If you press the trunk open button (3) for more than 1 second, the trunk opens.
- If you press the door lock button (1) or trunk open button (3) when the Smart Trunk release function is not in the Detect and Alert stage, the smart trunk function will not be deactivated.
- In case you have deactivated the Smart Trunk function by pressing the smart key button and opened a door, the Smart Trunk release function can be activated again by closing and locking all doors.

### **Detecting area**



- The Smart Trunk release operates with a welcome alert if the smart key is detected within 20 ~ 40 inches from the trunk.
- The alert stops at once if the smart key is positioned outside the detecting area during the Detect and Alert stage.

### **i** Information

- The Smart Trunk release function will not work if any of the following occurs:
  - The smart key is close to a radio transmitter such as a radio station or an airport which can interfere with normal operation of the transmitter.
  - The smart key is near a mobile two way radio system or a cellular phone.
  - Another vehicle's smart key is being operated close to your vehicle.
- The detecting range may decrease or increase when :
  - One side of the tire is raised to replace a tire or to inspect the vehicle.
  - The vehicle is slantingly parked on a slope or unpaved road, etc.

## FUEL FILLER DOOR

### Opening the fuel filler door



The fuel filler door must be opened from inside the vehicle by pulling up the fuel filler door opener.

1. Turn the engine off.
2. Pull up the fuel filler door opener.



3. Pull the fuel filler door (1) out to fully open.
4. To remove the fuel tank cap (2), turn it counterclockwise. You may hear a hissing noise as the pressure inside the tank equalizes.
5. Place the cap on the fuel filler door.

### **i** Information

Open and close the reservoir cap by using the handle on the cap cover for safety.

### **i** Information

If the fuel filler door does not open because ice has formed around it, tap lightly or push on the door to break the ice and release the door. Do not pry on the door. If necessary, spray around the door with an approved de-icer fluid (do not use radiator anti-freeze) or move the vehicle to a warm place and allow the ice to melt.

### Closing the fuel filler door

1. To install the fuel tank cap, turn it clockwise until it "Clicks".
2. Close the fuel filler door until it is latched securely.

### **!** WARNING

Gasoline is highly flammable and explosive. Failure to follow these guidelines may result in **SERIOUS INJURY** or **DEATH**:

- Read and follow all warnings posted at the gas station.
- Before refueling, note the location of the Emergency Gasoline Shut-Off, if available, at the gas station.
- Before touching the fuel nozzle, you should eliminate the potential build-up of static electricity by touching a metal part of the vehicle, a safe distance away from the fuel filler neck, nozzle, or other gas source, with your bare hand.
- Do not use cellular phones while refueling. Electric current and/or electronic interference from cellular phones can potentially ignite fuel vapors and cause a fire.

- Do not get back into a vehicle once you have begun refueling. You can generate a build-up of static electricity by touching, rubbing or sliding against any item or fabric capable of producing static electricity. Static electricity discharge can ignite fuel vapors causing a fire. If you must re-enter the vehicle, you should once again eliminate potentially dangerous static electricity discharge by touching a metal part of the vehicle, away from the fuel filler neck, nozzle or other gasoline source, with your bare hand.
- When refueling, always move the shift lever to the P (Park) position, set the parking brake, and place the ignition switch to the LOCK/OFF position.
- Sparks produced by electrical components related to the engine can ignite fuel vapors causing a fire.
- When using an approved portable fuel container, be sure to place the container on the ground prior to refueling. Static electricity discharge from the container can ignite fuel vapors causing a fire. Once refueling has begun, contact between your bare hand and the vehicle should be maintained until the filling is complete.
- Use only approved portable plastic fuel containers designed to carry and store gasoline.
- Do not use matches or a lighter and do not smoke or leave a lit cigarette in your vehicle while at a gas station, especially during refueling.
- Do not over-fill or top-off your vehicle tank, which can cause gasoline spillage.
- If a fire breaks out during refueling, leave the vicinity of the vehicle, and immediately contact the manager of the gas station and then contact the local fire department. Follow any safety instructions they provide.
- If pressurized fuel sprays out, it can cover your clothes or skin and thus subject you to the risk of fire and burns. Always remove the fuel cap carefully and slowly. If the cap is venting fuel or if you hear a hissing sound, wait until the condition stops before completely removing the cap.
- Always check that the fuel cap is installed securely to prevent fuel spillage in the event of an accident.

### **i** Information

Make sure to refuel your vehicle according to the “Fuel Requirements” suggested in the Introduction chapter.

### **NOTICE**

- Do not spill fuel on the exterior surfaces of the vehicle. Any type of fuel spilled on painted surfaces may damage the paint.
- If the fuel filler cap requires replacement, use only a genuine HYUNDAI cap or the equivalent specified for your vehicle. An incorrect fuel filler cap can result in a serious malfunction of the fuel system or emission control system.

## EXTERIOR LIGHTS

### Lighting control

To operate the lights, turn the knob at the end of the control lever to one of the following positions:



1. OFF position
2. AUTO headlamp position
3. Parking lamp position
4. Headlamp position

### Daytime running light (DRL)

The Daytime Running Lights (DRL) can make it easier for others to see the front of your vehicle during the day, especially after dawn and before sunset.

The DRL system will turn the dedicated lamp OFF when:

- The headlamps are ON.
- The parking lamps are ON.
- The vehicle is turned off.
- The parking brake is engaged.

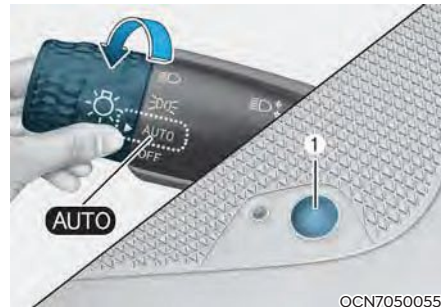

### AUTO headlamp position

The parking lamp and headlamp will be turned ON or OFF automatically depending on the amount of daylight as measured by the ambient light sensor on the center dash (1).

Even with the AUTO headlamp feature in operation, it is recommended to manually turn ON the headlamps when driving at night or in a fog, driving in the rain, or when you enter dark areas, such as tunnels and parking facilities.

### NOTICE

- Do not cover or spill anything on the sensor (1) located in front of the instrument panel.
- Do not clean the sensor using a window cleaner, the cleanser may leave a light film which could interfere with sensor operation.
- If your vehicle has window tint or other types of metallic coating on the front windshield, the AUTO headlamp system may not work properly.



ODN8A059202

### **Parking lamp position** (P)

The parking lamp, license plate lamp and instrument panel lamp are turned ON.



ODN8A059203

### **Headlamp position** (H)

The headlamp, parking lamp, license plate lamp and instrument panel lamp are turned ON.

### **i Information**

The ignition switch must be in the ON position to turn on the headlamp.

### **High beam operation**

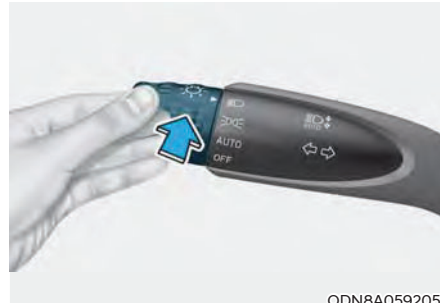

ODN8A059205

To turn on the high beam headlamp, push the lever away from you. The lever will return to its original position.

The high beam indicator will light when the headlamp high beams are switched on.

To turn off the high beam headlamp, pull the lever towards you. The low beams will turn on.

### **! WARNING**

**Do not use high beam when there are other vehicles approaching you. Using high beam could obstruct the other driver's vision.**



ODN8A059204

To flash the high beam headlamp, pull the lever towards you, then release the lever. The high beams will remain ON as long as you hold the lever towards you.

### Turn signals and lane change signals

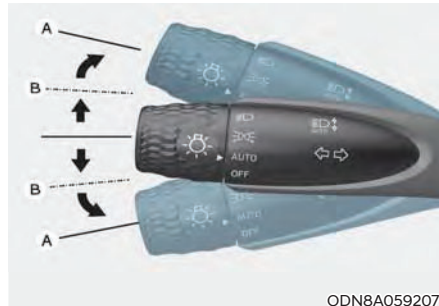

ODN8A059207

To signal a turn, push down on the lever for a left turn or up for a right turn in position (A). To signal a lane change, move the turn signal lever slightly and hold it in position (B). The lever will return to the OFF position when released or when the turn is completed.

If an indicator stays on and does not flash or if it flashes abnormally, one of the turn signal bulbs may be burned out and will require replacement.

#### **One touch turn signal function**

To activate a one-touch turn signal function, move the turn signal lever slightly and then release it. The lane change signals will blink 3, 5 or 7 times.

You can activate or deactivate the One Touch Turn Signal function or choose the number of blinks (3, 5, or 7) from the User Settings Mode on the LCD display.

For more details, refer to "LCD Display Modes" in chapter 4. If your vehicle is equipped with additional navigation, please refer to the infotainment system manual separately supplied.

### Battery saver function

The purpose of this feature is to help prevent the battery from being discharged. The system automatically turns off the parking lamp when the driver turns the vehicle off and opens the driver-side door.

With this feature, the parking lamps will turn off automatically if the driver parks on the side of road at night.

If necessary, to keep the lamps on when the vehicle is turned off, perform the following:

- (1) Open the driver-side door.
- (2) Turn the parking lamps OFF and ON again using the headlamp switch on the steering column.

### Headlamp delay function (if equipped)

If you place the ignition switch in the ACC or OFF position with the headlamps ON, the headlamps (and/or parking lamps) remain on for about 5 minutes. However, with the engine off if the driver's door is opened and closed, the headlamps (and/or parking lamps) are turned off after 15 seconds.

The headlamps (and/or parking lamps) can be turned off by pressing the lock button on the remote key or smart key twice or turning the light switch to the OFF or AUTO position. However, if you turn the light switch to the AUTO position when it is dark outside, the headlamps will not be turned off.

You can activate or deactivate the Headlamp Delay function from the User Settings Mode in the LCD display.

For more details, refer to "LCD Display Modes" in chapter 4. If your vehicle is equipped with additional navigation, please refer to the infotainment system manual separately supplied.

#### **NOTICE**

**If the driver exits the vehicle through another door besides the driver door, the battery saver function does not operate and the headlamp delay function does not turn OFF automatically.**

**This may cause the battery to discharge. To avoid battery discharge, turn OFF the headlamps manually from the headlamp switch before exiting the vehicle.**

## HIGH BEAM ASSIST (HBA) (IF EQUIPPED)



OCN7050141N

High Beam Assist will automatically adjust the headlamp range (switches between high beam and low beam) depending on the brightness of detected vehicles and certain road conditions.

### Detecting sensor (Front view camera)



©CN7060030

[1] : Front view camera

The front view camera is used as a detecting sensor to help detect ambient light and brightness while driving.

Refer to the picture above for the detailed location of the detecting sensor.

### NOTICE

Always keep the front view camera in good condition to maintain optimal performance of High Beam Assist.

For more details on the precautions of the front view camera, refer to “Forward Collision-Avoidance Assist (FCA)” section in chapter 7.

### Function settings

With the engine on, select ‘Lights → High Beam Assist (or HBA (High Beam Assist))’ from the Settings menu to turn on High Beam Assist and deselect to turn off the system.



### WARNING

For your safety, change the Settings after parking the vehicle at a safe location.



## Function operation

### Display and control

- After selecting 'High Beam Assist' in the Settings menu, High Beam Assist will operate by following the procedure below.
  - Place the headlamp switch in the AUTO position and push the headlamp lever towards the instrument cluster. The High Beam Assist (AUTO) indicator light will illuminate on the cluster and the system will be enabled.
  - When the system is enabled, high beam will turn on when vehicle speed is above 25 mph (40 km/h). When vehicle speed is below 15 mph (25 km/h), high beam will not turn on.
  - The High Beam (H) indicator light will illuminate on the cluster when high beam is on.
- When High Beam Assist is operating, if the headlamp lever or switch is used, the system operates as follow:
  - If the headlamp lever is pulled towards you when the high beam is off, the high beam will turn on without High Beam Assist canceled. When you let go of the headlamp lever, the lever will move to the middle and the high beam will turn off.
  - If the headlamp lever is pulled towards you when the high beam is on by High Beam Assist, low beam will be on and the system will turn off.
  - If the headlamp switch is placed from AUTO to another position (headlamp/position/off), High Beam Assist will turn off and the corresponding lamp will turn on.

- When High Beam Assist is operating, high beam switches to low beam if any of the following conditions occur:
  - When the headlamp of an oncoming vehicle is detected.
  - When the tail lamp of a vehicle in front is detected.
  - When the headlamp or tail lamp of a motorcycle or a bicycle is detected.
  - When the surrounding ambient light is bright enough that high beams are not required.
  - When streetlights or other lights are detected.

## Function malfunction and limitations

### Function malfunction

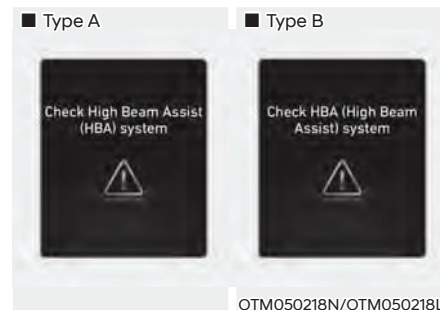

When High Beam Assist is not working properly, the 'Check High Beam Assist (HBA) system' or 'Check HBA (High Beam Assist) system' warning message will appear and  warning light will illuminate on the cluster. Take your vehicle to an authorized HYUNDAI dealer and have the function checked.

### **Limitations of the function**

High Beam Assist may not work properly in the following situations:

- Light from a vehicle is not detected because of lamp damage, or because it is hidden from sight, etc.
- Headlamp of a vehicle is covered with dust, snow or water.
- A vehicle's headlamps are off but the fog lamps are on and etc.
- There is a lamp that has a similar shape as a vehicle's lamp.
- Headlamps have been damaged or not repaired properly.
- Headlamps are not aimed properly.
- Driving on a narrow curved road, rough road, uphill or downhill.
- Vehicle in front is partially visible on a crossroad or curved road.
- There is a traffic light, reflecting sign, flashing sign or mirror ahead.
- There is a temporary reflector or flash ahead (construction area).
- The road conditions are bad such as being wet, iced or covered with snow.
- A vehicle suddenly appears from a curve.
- The vehicle is tilted from a flat tire or is being towed.
- Light from a vehicle is not detected because of exhaust fume, smoke, fog, snow, etc.

**For more details on the limitations of the front view camera, refer to "Forward Collision-Avoidance Assist (FCA)" section in chapter 7.**



### **WARNING**

- **At times, High Beam Assist may not work properly. It is the responsibility of the driver for safe driving practices and always check the road conditions for your safety.**
- **When High Beam Assist does not operate normally, change the headlamp position manually between high beam and low beam.**

## INTERIOR LIGHTS



### WARNING

Do not use the interior lights when driving in the dark. The interior lights may obscure your view and cause an accident.

### NOTICE

Do not use the interior lights for extended periods when the vehicle is turned off or the battery will discharge.

### Interior lamp AUTO cut

The interior lamps will automatically go off approximately 20 minutes after the engine is turned off and the doors are closed. If a door is opened, the lamp will go off 40 minutes after the engine is turned off. If the doors are locked by the remote key or smart key and the vehicle enters the armed stage of the theft alarm system, the lamps will go off five seconds later.

### Front lamps

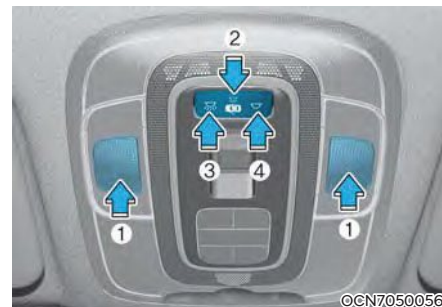

- (1) Front Map Lamp
- (2) Front Door Lamp
- (3) Front Room Lamp ON
- (4) Front Room Lamp OFF



#### Front map lamp:

Press either of these lens to turn the map lamp on or off. This light produces a spot beam for convenient use as a map lamp at night or as a personal lamp for the driver and the front passenger.

**Front Door Lamp (  ):**

The front or rear room lamps come on when the front or rear doors are opened if the engine is running or not. When doors are unlocked by the remote key or smart key, the front and rear lamps come on for approximately 30 seconds as long as any door is not opened. The front and rear room lamps go out gradually after approximately 30 seconds if the door is closed. However, if the ignition switch is in the ON position or all doors are locked, the front and rear lamps will turn off. If a door is opened with the ignition switch in the ACC position or the OFF position, the front and rear lamps stay on for about 20 minutes.

**Front room lamp**

-  :  
Press the button to turn ON the room lamp for the front/rear seats.
-  :  
Press the button to turn OFF the room lamp for the front/rear seats.

**Rear lamp**



**Rear Room Lamp (  ):**

Press this switch to turn the rear room lamp on and off.

**NOTICE**

**Do not leave the lamp switches on for an extended period of time when the engine is turned off.**

### Luggage compartment lamp



The luggage compartment lamp comes on when the trunk is opened.



#### **NOTICE**

The luggage compartment lamp comes on as long as the trunk is open. To prevent unnecessary battery system drain, close the trunk securely after using the luggage compartment.

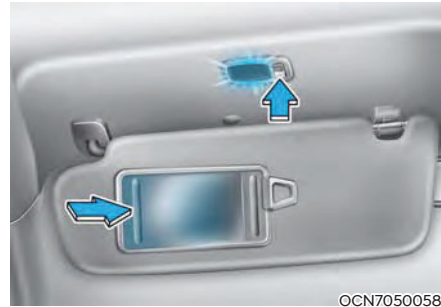
### Vanity mirror lamp (if equipped)



Push the switch to turn the light on or off.

-  : The lamp will turn on if this button is pressed.
-  : The lamp will turn off if this button is pressed.

#### **NOTICE**

Always have the switch in the off position when the vanity mirror lamp is not in use. If the sunvisor is closed without the lamp off, it may discharge the battery or damage the sunvisor.

### Welcome system (if equipped) **Welcome light**



#### **Door handle lamp (if equipped)**

When all the doors (and trunk) are closed and locked, the door handle lamp will come on for about 15 seconds if any of the below is performed.

- When the door unlock button is pressed on the remote key or smart key.
- When the button of the outside door handle is pressed.
- When the vehicle is approached with the smart key in possession.

#### **Headlamp and parking lamp**

When the headlamp (lamp switch in the headlamp or AUTO position) is on and all doors (and trunk) are locked and closed, the headlamp and parking lamp will come on for 15 seconds if/or any of the below is performed.

- When the door unlock button is pressed on the remote key or smart key.

At this time, if you press the door lock or unlock button, the headlamp and parking lamp will turn off immediately.

You can activate or deactivate the Welcome Light from the User Settings Mode on the LCD display. **For more details, refer to “LCD Display” in chapter 4. If your vehicle is equipped with additional navigation, please refer to the infotainment system manual separately supplied.**

#### **Interior lamp**

When the interior lamp switch is in the DOOR position and all doors (and trunk) are closed and locked, the room lamp will come on for 30 seconds if any of the below is performed.

- When the door unlock button is pressed on the remote key or smart key.
- When the button of the outside door handle is pressed.

At this time, if you press the door lock or unlock button, the room lamp will turn off immediately.

## WIPERS AND WASHERS

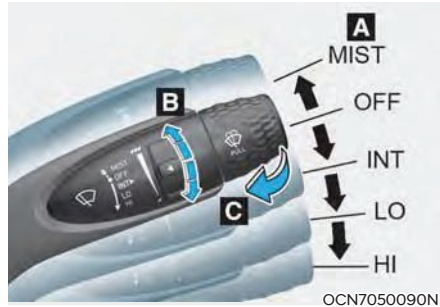

### A. Wiper speed control

- MIST – Single wipe
- OFF – Off
- INT / --- – Intermittent wipe
- LO– Low wiper speed
- HI – High wiper speed

### B. Intermittent control wipe time adjustment

### C. Wash with brief wipes (pull lever towards you)

## Windshield Wipers

Operates as follows when the ignition switch is in the ON position.

**MIST:** For a single wiping cycle, push the lever upward and release. The wipers will operate continuously if the lever is held in this position.

**OFF:** Wiper is not in operation.

**INT:** Wiper operates intermittently at the same wiping intervals. To vary the speed setting, move the speed control lever. The top most setting will run the wipers most frequently (for more rain). The bottom setting will run the wipers the least frequently (for less rain).

**LO:** The wiper runs at a lower speed.

**HI:** The wiper runs at a higher speed.

## **i** Information

**If there is heavy accumulation of snow or ice on the windshield, defrost the windshield for about 10 minutes, or until the snow and/or ice is removed before using the windshield wipers to ensure proper operation.**

**If you do not remove the snow and/or ice before using the wiper and washer, it may damage the wiper and washer system.**

## Windshield Washers



In the OFF position, pull the lever gently toward you to spray washer fluid on the windshield and to run the wipers 1-3 cycles. The spray and wiper operation will continue until you release the lever. If the washer does not work, you may need to add washer fluid to the washer fluid reservoir.



### **WARNING**

When the outside temperature is below freezing, **ALWAYS** warm the windshield using the defroster to help prevent the washer fluid from freezing on the windshield and obscuring your vision which could result in an accident and serious injury or death.

### **NOTICE**

- To prevent possible damage to the washer pump, do not operate the washer when the fluid reservoir is empty.
- To prevent possible damage to the wipers or windshield, do not operate the wipers when the windshield is dry.
- To prevent damage to the wiper arms and other components, do not attempt to move the wipers manually.
- To prevent possible damage to the wipers and washer system, use anti-freezing washer fluids in the winter season or cold weather.



**MANUAL CLIMATE CONTROL SYSTEM (IF EQUIPPED)**

## ■ Type A



OCN7050100N



## ■ Type B



OCN7050101N

1. Fan speed control knob
2. Temperature control knob
3. Mode selection knob
4. Front windshield defroster position
5. Rear window defroster button
6. Air intake control button
7. A/C (Air conditioning) button

### Heating and Air Conditioning

1. Start the engine.
2. Set the mode to the desired position.  
To improve the effectiveness of heating and cooling, select the mode according to the following:
  - Heating: 
  - Cooling: 
3. Set the temperature control to the desired position.
4. Set the air intake control to fresh mode or recirculation mode position.
5. Set the fan speed control to the desired speed.
6. If air conditioning is desired, turn the air conditioning system on.

When starting the vehicle in cold weather a more efficient way to heat the passenger compartment is to do the following.

- Turn off or lower the blower, right after starting the engine.
  - Engine temperature is still low and the air flow from the heater is still cold.
- After a few minutes of engine warm up, turn on or set the fan to a higher level and adjust the temperature setting towards hot.

**Mode selection**

OCN7050134N

## Convenient Features

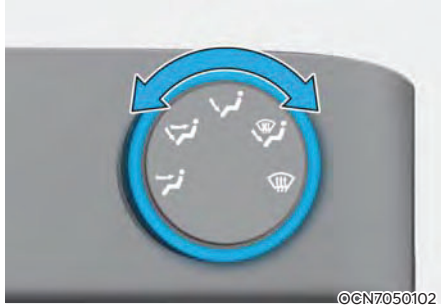

©CN7050102

The mode selection knob controls the direction of the air flow through the ventilation system.

Air can be directed to the floor, dashboard outlets, or windshield. Five symbols are used to represent Face, Bi-Level, Floor, Floor-Defrost and Defrost air position.



**Face-Level (B, D)**

Air flow is directed toward the upper body and face. Additionally, each outlet can be controlled to direct the air discharged from the outlet.



**Bi-Level (B, C, D, E)**

Air flow is directed towards the face and the floor.



**Floor-Level (A, C, D, E)**

Most of the air flow is directed to the floor, with a small amount of the air being directed to the windshield and side window defrosters.



**Floor & Defrost (A, C, D, E)**

Most of the air flow is directed to the floor and the windshield with a small amount directed to the side window defrosters.



**Defrost-Level (A, D)**

Most of the air flow is directed to the windshield with a small amount of air directed to the side window defrosters.



©CN7050104

### **MAX A/C-Level (B, D) (if equipped)**

The MAX A/C mode is used to cool the inside of the vehicle faster. Air flow is directed toward the upper body and face.

In this mode, the air conditioning and the recirculated air position cannot be selected. Turn the fan speed mode to adjust.

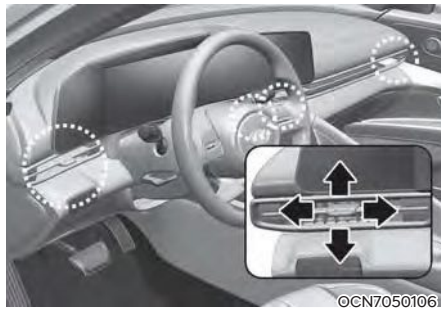
**Instrument panel vents**

©CN7050106

**Instrument panel vents**

The instrument panel vent air flow can be directed up/down or left/right using the vent adjustment lever.

To close the vent, push the air vent lever in the opposite direction of the passenger. To open the vent, push the air vent lever in the same direction of the passenger.

**Temperature control**

©CN7050105

The temperature will increase by turning the knob to the right.

The temperature will decrease by turning the knob to the left.

**Air intake control**

OCN7050107

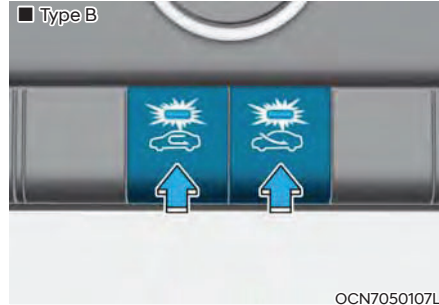

OCN7050107L

The air intake control button is used to select either Fresh mode (outside air) or Recirculation mode (cabin air).

### Recirculation mode



When Recirculation mode is selected, air from the passenger compartment will be recirculated through the system and heated or cooled according to the function selected.

### Fresh mode

#### ■ Type A



When Fresh mode is selected, air enters the vehicle from outside and is heated or cooled according to the function selected.

#### ■ Type B



### **i** Information

Operating the system primarily in Fresh mode is recommended. Use Recirculation mode temporarily only when needed.

**Prolonged operation of the heater in Recirculation mode and without the A/C ON can cause fogging of the windshield.**

**In addition, prolonged use of the A/C ON in Recirculation mode may result in excessively dry, dehumidified air in the cabin and may promote formation of musty vent odor due to stagnant air.**

### **WARNING**

- **Continued use of the climate control system operation in Recirculation mode for a prolonged period of time may cause drowsiness to the occupants in the cabin. This may lead to loss of vehicle control which may lead to an accident.**
- **Continued use of the climate control system operation in Recirculation mode with the A/C OFF may allow humidity to increase inside the cabin. This may cause condensation to accumulate on the windshield and obscure visibility.**
- **Do not sleep in your vehicle or remain parked in your vehicle with the windows up and either the heater or the air conditioning ON for prolonged periods of time. Doing so may increase the levels of carbon dioxide in the cabin which may lead to serious injury or death.**

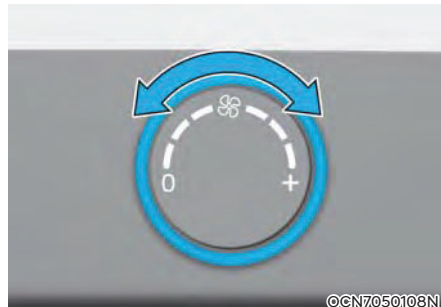
**Fan speed control**

Turn the knob to the right to increase the fan speed and airflow. Turn the knob to the left to decrease fan speed and airflow.

Setting the fan speed control knob to the "0" position turns off the fan.

**NOTICE**

Operating the fan speed when the ignition switch is in the ON position could cause the battery to discharge. Operate the fan speed when the engine is running.

**Air conditioning (if equipped)**

Press the A/C button to turn the air conditioning system on (indicator light will illuminate). Press the button again to turn the air conditioning system off.



### System operation

#### Ventilation

1. Select the Face Level  mode.
2. Set the air intake control to fresh mode.
3. Set the temperature control to the desired position.
4. Set the fan speed control to the desired speed.

#### Heating

1. Select the Floor Level  mode.
2. Set the air intake control to fresh mode.
3. Set the temperature control to the desired position.
4. Set the fan speed control to the desired speed.
5. If desired, turn the air conditioning ON with the temperature control knob set to heat in order to dehumidify the air before it enters into the cabin.

If the windshield fogs up, select the Floor & Defrost  mode or rotate the mode selecting knob to the Defrost  mode.

#### Operation Tips

- To help keep dust or unpleasant fumes from entering the vehicle through the ventilation system, temporarily set the air intake control to the recirculation mode. Be sure to return the control to fresh mode position when the irritation has passed to keep fresh air in the vehicle. This will help keep the driver alert and comfortable.
- To help prevent interior fog on the windshield, set the air intake control to fresh mode and fan speed to the desired position, turn on the air conditioning system, and adjust the temperature control to desired temperature.

#### Air conditioning

HYUNDAI Air Conditioning Systems are filled with R-1234yf refrigerant.

1. Start the vehicle.
2. Push the air conditioning button.
3. Select the Face Level  mode.
4. Set the air intake control to Recirculation mode temporarily to allow the cabin to cool quickly. When the desired temperature in the cabin is reached, change the air intake control back to Fresh mode.
5. Adjust the fan speed control and temperature control to maintain maximum comfort.

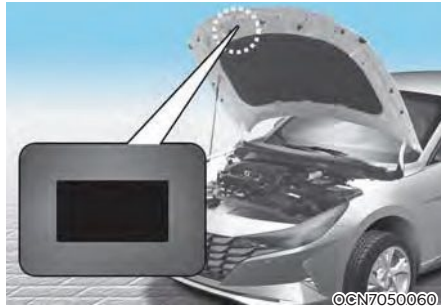

**i** Information

Your vehicle is filled with R-1234yf according to the regulation in your country at the time of production. You can find out which air conditioning refrigerant is applied to your vehicle on the label located inside of the hood.

**NOTICE**

- The refrigerant system should only be serviced by trained and certified technicians to insure proper and safe operation.
- The refrigerant system should be serviced in a well-ventilated place.
- The air conditioning evaporator (cooling coil) shall never be repaired or replaced with one removed from a used or salvaged vehicle and new replacement MAC evaporators shall be certified (and labeled) as meeting SAE Standard J2842.

**i** Information

- When using the air conditioning system, monitor the temperature gauge closely while driving up hills or in heavy traffic when outside temperatures are high. Air conditioning system operation may cause engine overheating. Continue to use the blower fan but turn the air conditioning system off if the temperature gauge indicates engine overheating.
- When opening the windows in humid weather, air conditioning may create water droplets inside the vehicle. Since excessive water droplets may cause damage to electrical equipment, air conditioning should only be used with the windows closed.

### Air conditioning system operation tips

- If the vehicle has been parked in direct sunlight during hot weather, open the windows for a short time to let the hot air inside the vehicle escape.
- After sufficient cooling has been achieved, switch back from recirculation mode to fresh mode.
- To help reduce moisture inside of the windows on rainy or humid days, decrease the humidity inside the vehicle by operating the air conditioning system with the windows and sunroof closed.
- During air conditioning system operation, you may occasionally notice a slight change in engine speed as the air conditioning compressor cycles. This is a normal system operation characteristic.
- Use the air conditioning system every month only for a few minutes to ensure maximum system performance.
- When using the air conditioning system, you may notice clear water dripping (or even puddling) on the ground under the passenger side of the vehicle. This is a normal system operation characteristic.
- If you operate the air conditioner excessively, the difference between the temperature of the outside air and that of the windshield could cause the outer surface of the windshield to fog up, causing loss of visibility. In this case, set the mode selection button to the  position and set the fan speed control knob to the lowest speed setting.

## System Maintenance

### Cabin air filter

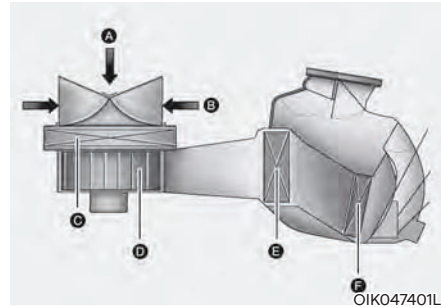

[A] : Outside air, [B] : Recirculated air  
[C] : Cabin air filter, [D] : Blower  
[E] : Evaporator core, [F] : Heater core

The cabin air filter is installed behind the glove box. It filters the dust or other pollutants that enter the vehicle through the heating and air conditioning system.

Have the cabin air filter replaced by an authorized HYUNDAI dealer according to the maintenance schedule. If the vehicle is being driven in severe conditions such as dusty or rough roads, more frequent cabin air filter inspections and changes are required.

If the air flow rate suddenly decreases, the system should be checked at an authorized HYUNDAI dealer.

### Information

- **Replace the filter according to the Maintenance Schedule.**
- **If the car is being driven in severe conditions such as dusty, rough roads, more frequent cabin air filter inspections and changes are required.**
- **When the air flow rate suddenly decreases, we recommend that the system be checked by an authorized HYUNDAI dealer.**

### Checking the amount of air conditioner refrigerant and compressor lubricant

When the amount of refrigerant is low, the performance of the air conditioning is reduced. Overfilling also reduces the performance of the air conditioning system.

Therefore, if abnormal operation is found, have the system inspected by an authorized HYUNDAI dealer.

#### NOTICE

It is important that the correct type and amount of oil and refrigerant are used. Otherwise, damage to the compressor and abnormal system operation may occur. To prevent damage, the air conditioning system in your vehicle should only be serviced by trained and certified technicians.



#### WARNING

Vehicles equipped with R-1234yf



Since the refrigerant is mildly flammable and operated at high pressure, the air conditioning system should only be serviced by trained and certified technicians. It is important that the correct type and amount of oil and refrigerant are used.

All refrigerants should be reclaimed with proper equipment.

Venting refrigerants directly to the atmosphere is harmful to individuals and environment. Failure to heed these warnings can lead to serious injuries.



#### Air conditioning refrigerant label

You can find out which air conditioning refrigerant is applied to your vehicle on the label located inside of the hood.

#### Example

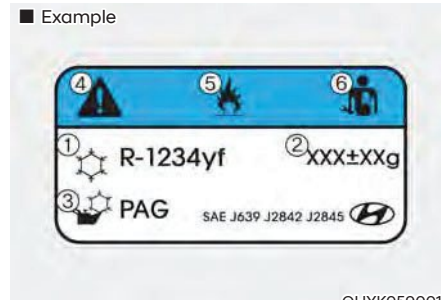

OHYK059001

Each symbols and specification on the air conditioning refrigerant label is represented as below:

1. Classification of refrigerant
2. Amount of refrigerant
3. Classification of Compressor lubricant
4. Caution
5. Flammable refrigerant
6. To require registered technician to service air conditioning system

## AUTOMATIC CLIMATE CONTROL SYSTEM (IF EQUIPPED)



OCN7050110L

1. Driver's temperature control knob
2. Passenger's temperature control knob
3. AUTO (automatic control) button
4. SYNC button
5. OFF button
6. Front windshield defroster button
7. Air conditioning button
8. Air intake control button
9. Rear window defroster button
10. Fan speed control button
11. Mode selection button
12. Climate control information screen

## Automatic heating and air conditioning



### 1. Press the AUTO button

The modes, fan speeds, air intake and air-conditioning will be controlled automatically according to the temperature setting you select.



You can control the blower strength in three stages by pushing the AUTO button during automatic operation.

- HIGH : Provide rapid air conditioning and heating with strong blower
- MEDIUM : Provide air conditioning and heating with medium strength blower
- LOW : Is suitable for drivers that prefer lower air speeds

When you select the temperature to HI or LO in AUTO mode, the fan speed is set to 'HIGH'.

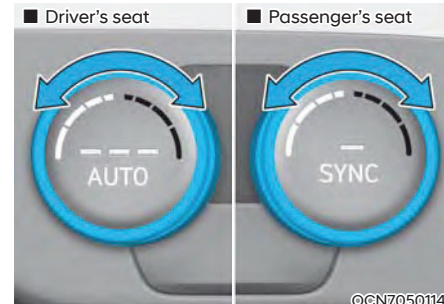

### 2. Turn the temperature control knob to set the desired temperature. If the temperature is set to the lowest setting (Lo), the air conditioning system will operate continuously.

- To turn the automatic operation off, select any button of the following:
  - Mode selection button
  - Front windshield defroster button (Press the button one more time to deselect the front windshield defroster function. The 'AUTO' sign will illuminate on the information screen once again.)
  - Fan speed control toggle switch
 The selected function will be controlled manually while other functions operate automatically.
- For your convenience and overall system efficiency, use the AUTO button and set the temperature to 72°F (22°C).

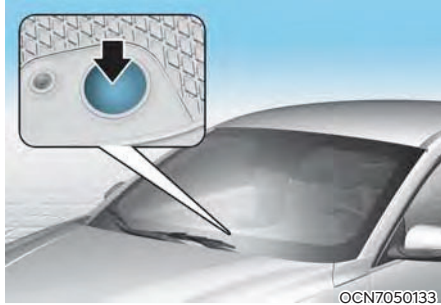



**i** Information

Never place anything near the sensor to ensure better control of the heating and cooling system.

### Manual heating and air conditioning

The heating and cooling system can be controlled manually by pushing buttons other than the AUTO button. In this case, the system works sequentially according to the order of buttons selected. When pressing any button except the AUTO button while using automatic operation, the functions not selected will be controlled automatically.

1. Start the engine.
2. Set the mode to the desired position.  
To improve the effectiveness of heating and cooling, select the mode according to the following:
  - Heating: 
  - Cooling: 
3. Set the temperature control to the desired position.
4. Set the air intake control to fresh mode.
5. Set the fan speed control to the desired speed.
6. If air conditioning is desired, turn the air conditioning system on.
7. Press the AUTO button in order to convert to full automatic control of the system.

**Mode selection**

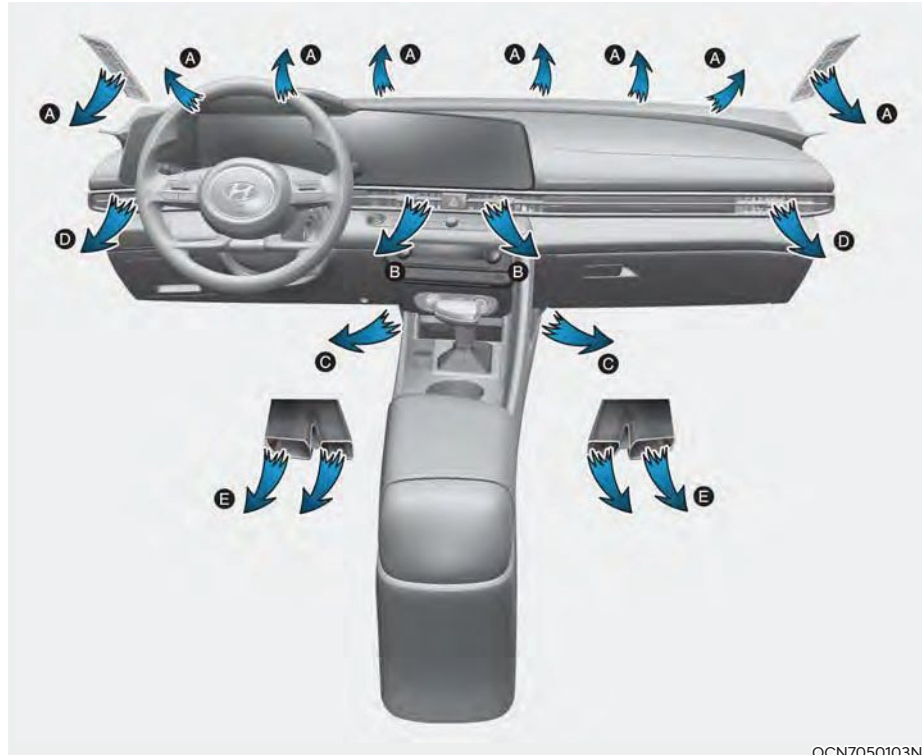

OCN7050103N

## Convenient Features

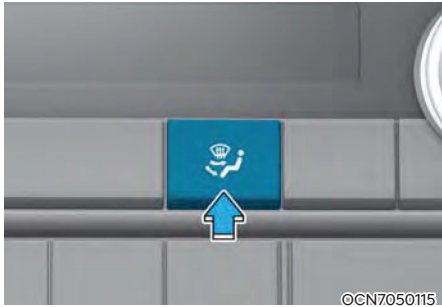

The mode selection toggle switch controls the direction of the air flow through the ventilation system.

The air flow outlet direction is cycled as follows:



### Face-level (B, D)

Air flow is directed toward the upper body and face. Additionally, each outlet can be controlled to direct the air discharged from the outlet.

### Bi-Level (B, C, D, E)

Air flow is directed towards the face and the floor.

### Floor-Level (A, C, D, E)

Most of the air flow is directed to the floor, with a small amount of the air being directed to the windshield and side window defrosters.

### Floor & Defrost (A, C, D, E)

Most of the air flow is directed to the floor and the windshield with a small amount directed to the side window defrosters.



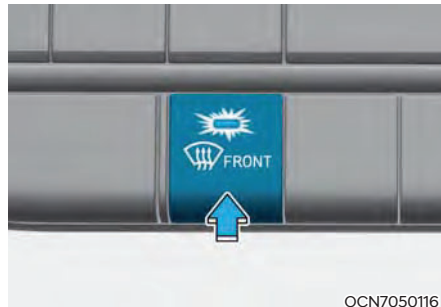

#### Defrost-Level (A, D)

Most of the air flow is directed to the windshield with a small amount of air directed to the side window defrosters.



#### Instrument panel vents

The instrument panel vent air flow can be directed up/down or left/right using the vent adjustment lever.

To close the vent, push the air vent lever in the opposite direction of the passenger. To open the vent, push the air vent lever in the same direction of the passenger.

#### Temperature control

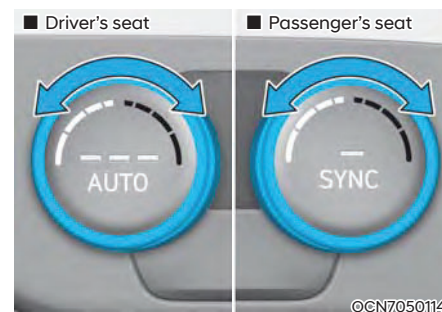

The temperature will increase by turning the knob to the right.

The temperature will decrease by turning the knob to the left.

The temperature will increase or decrease by 1°F (0.5°C) for each incremental location. When set to the lowest temperature setting, the air conditioning will operate continuously.



### Adjusting the driver and passenger side temperature equally

- Press the “SYNC” button to adjust the driver and passenger side temperature equally.
- The passenger side temperature will be set to the same temperature as the driver side temperature.
- Turn the driver side temperature control knob. The driver and passenger side temperature will be adjusted equally.
- If you rotate the passenger’s temperature control knob, the SYNC button is off and the passenger side temperature can be operated individually.

### Adjusting the driver and passenger side temperature individually

Press the “SYNC” button again to adjust the driver and passenger side temperature individually. The button indicator will turn off.

### Temperature conversion

If the battery has been discharged or disconnected, the temperature mode display will reset to Centigrade.

To change the temperature unit from °C to °F or °F to °C :

- Automatic climate control system  
Press the AUTO button for 3 seconds while pressing the OFF button.
- Instrument cluster Automatic climate control system  
Go to User Settings → Other → Temperature Unit.

The temperature unit on both the cluster LCD display and the climate control screen will change.

### Air intake control

#### Recirculated air position



With the recirculated air position selected, air from the passenger compartment will be drawn through the heating system and heated or cooled according to the function selected.

#### Outside (fresh) air position



With the outside (fresh) air position selected, air enters the vehicle from outside and is heated or cooled according to the function selected.

### **i** Information

Operating the system primarily in Fresh mode is recommended. Use Recirculation mode temporarily only when needed.

Prolonged operation of the heater in Recirculation mode and without the A/C ON can cause fogging of the windshield.

In addition, prolonged use of the A/C ON in Recirculation mode may result in excessively dry, dehumidified air in the cabin and may promote formation of musty vent odor due to stagnant air.

### **⚠** WARNING

- Continued use of the climate control system operation in Recirculation mode for a prolonged period of time may cause drowsiness to the occupants in the cabin. This may lead to loss of vehicle control which may lead to an accident.
- Continued use of the climate control system operation in Recirculation mode with the A/C OFF may allow humidity to increase inside the cabin. This may cause condensation to accumulate on the windshield and obscure visibility.
- Do not sleep in your vehicle or remain parked in your vehicle with the windows up and either the heater or the air conditioning ON for prolonged periods of time. Doing so may increase the levels of carbon dioxide in the cabin which may lead to serious injury or death.

### **Fan speed control**

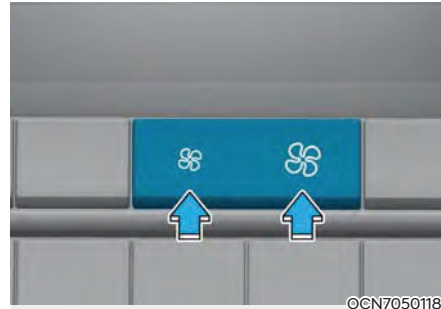

The fan speed can be set to the desired speed by using the fan speed control toggle switch.

More air is delivered with higher fan speeds.

Pressing the OFF button turns off the fan.

### **NOTICE**

Operating the fan speed when the ignition switch is in the ON position could cause the battery to discharge. Operate the fan speed when the engine is running.

### Air conditioning



Push the A/C button to manually turn the air conditioning system on (indicator light will illuminate).

Push the button again to turn the air conditioning system off.

### OFF mode

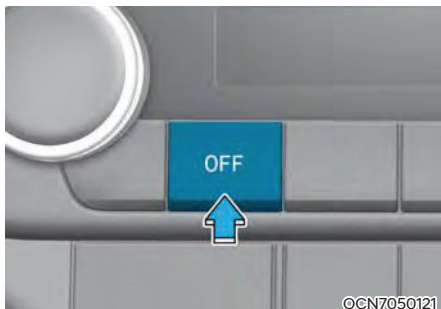

Push the OFF button of the front to turn off the air climate control system. However, you can still operate the mode and air intake buttons as long as the ignition switch is in the ON position.



## System operation

### Ventilation

1. Select the Face Level  mode.
2. Set the air intake control to fresh mode.
3. Set the temperature control to the desired position.
4. Set the fan speed control to the desired speed.

### Heating

1. Select the Floor Level  mode.
2. Set the air intake control to fresh mode.
3. Set the temperature control to the desired position.
4. Set the fan speed control to the desired speed.
5. If desired, turn the air conditioning ON with the temperature control knob set to heat in order to dehumidify the air before it enters into the cabin.

If the windshield fogs up, select the Front & Defrost  mode or press the Front Defrost  mode.

### Operation Tips

- To help keep dust or unpleasant fumes from entering the vehicle through the ventilation system, temporarily set the air intake control to the recirculation mode. Be sure to return the control to fresh mode position when the irritation has passed to keep fresh air in the vehicle. This will help keep the driver alert and comfortable.
- To help prevent interior fog on the windshield, set the air intake control to fresh mode and fan speed to the desired position, turn on the air conditioning system, and adjust the temperature control to desired temperature.

### **Air conditioning**

HYUNDAI Air Conditioning Systems are filled with R-1234yf refrigerant.

1. Start the vehicle.
2. Push the air conditioning button.
3. Select the Face Level  mode.
4. Set the air intake control to Recirculation mode temporarily to allow the cabin to cool quickly. When the desired temperature in the cabin is reached, change the air intake control back to Fresh mode.
5. Adjust the fan speed control and temperature control to maintain maximum comfort.

### **Information**

Your vehicle is filled with R-1234yf according to the regulation in your country at the time of production. You can find out which air conditioning refrigerant is applied to your vehicle on the label located inside of the hood.

### **NOTICE**

- The refrigerant system should only be serviced by trained and certified technicians to insure proper and safe operation.
- The refrigerant system should be serviced in a well-ventilated place.
- The air conditioning evaporator (cooling coil) shall never be repaired or replaced with one removed from a used or salvaged vehicle and new replacement MAC evaporators shall be certified (and labeled) as meeting SAE Standard J2842.

### **Information**

- When using the air conditioning system, monitor the temperature gauge closely while driving up hills or in heavy traffic when outside temperatures are high. Air conditioning system operation may cause engine overheating. Continue to use the blower fan but turn the air conditioning system off if the temperature gauge indicates engine overheating.
- When opening the windows in humid weather, air conditioning may create water droplets inside the vehicle. Since excessive water droplets may cause damage to electrical equipment, air conditioning should only be used with the windows closed.

### Air conditioning system operation tips

- If the vehicle has been parked in direct sunlight during hot weather, open the windows for a short time to let the hot air inside the vehicle escape.
- After sufficient cooling has been achieved, switch back from recirculation mode to fresh mode.
- To help reduce moisture inside of the windows on rainy or humid days, decrease the humidity inside the vehicle by operating the air conditioning system with the windows and sunroof closed.
- During air conditioning system operation, you may occasionally notice a slight change in engine speed as the air conditioning compressor cycles. This is a normal system operation characteristic.
- Use the air conditioning system every month only for a few minutes to ensure maximum system performance.
- When using the air conditioning system, you may notice clear water dripping (or even puddling) on the ground under the passenger side of the vehicle. This is a normal system operation characteristic.
- If you operate the air conditioner excessively, the difference between the temperature of the outside air and that of the windshield could cause the outer surface of the windshield to fog up, causing loss of visibility. In this case, set the mode selection button to the  position and set the fan speed control knob to the lowest speed setting.

## System Maintenance

### Cabin air filter

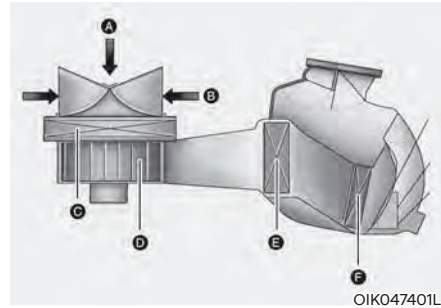

[A] : Outside air, [B] : Recirculated air  
[C] : Cabin air filter, [D] : Blower  
[E] : Evaporator core, [F] : Heater core

The cabin air filter is installed behind the glove box. It filters the dust or other pollutants that enter the vehicle through the heating and air conditioning system.

Have the cabin air filter replaced by an authorized HYUNDAI dealer according to the maintenance schedule. If the vehicle is being driven in severe conditions such as dusty or rough roads, more frequent cabin air filter inspections and changes are required.

If the air flow rate suddenly decreases, the system should be checked at an authorized HYUNDAI dealer.

### Information

- **Replace the filter according to the Maintenance Schedule.**
- **If the car is being driven in severe conditions such as dusty, rough roads, more frequent cabin air filter inspections and changes are required.**
- **When the air flow rate suddenly decreases, we recommend that the system be checked by an authorized HYUNDAI dealer.**

### Checking the amount of air conditioner refrigerant and compressor lubricant

When the amount of refrigerant is low, the performance of the air conditioning is reduced. Overfilling also reduces the performance of the air conditioning system.

Therefore, if abnormal operation is found, have the system inspected by an authorized HYUNDAI dealer.

#### NOTICE

It is important that the correct type and amount of oil and refrigerant are used. Otherwise, damage to the compressor and abnormal system operation may occur. To prevent damage, the air conditioning system in your vehicle should only be serviced by trained and certified technicians.



#### WARNING

Vehicles equipped with R-1234yf



Since the refrigerant is mildly flammable and operated at high pressure, the air conditioning system should only be serviced by trained and certified technicians. It is important that the correct type and amount of oil and refrigerant are used.

All refrigerants should be reclaimed with proper equipment.

Venting refrigerants directly to the atmosphere is harmful to individuals and environment. Failure to heed these warnings can lead to serious injuries.



#### Air conditioning refrigerant label

You can find out which air conditioning refrigerant is applied to your vehicle on the label located inside of the hood.

#### Example

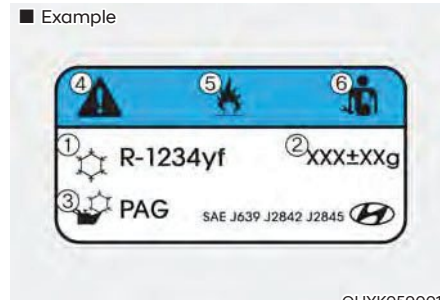



Each symbols and specification on the air conditioning refrigerant label is represented as below:

1. Classification of refrigerant
2. Amount of refrigerant
3. Classification of Compressor lubricant
4. Caution
5. Flammable refrigerant
6. To require registered technician to service air conditioning system

## WINDSHIELD DEFROSTING AND DEFOGGING

### WARNING

#### Windshield heating



Do not use the  or  position during cooling operation in extremely humid weather. The difference between the temperature of the outside air and that of the windshield could cause the outer surface of the windshield to fog up, causing loss of visibility. In this case, set the mode selection knob or button to the  position and fan speed control knob or button to lower speed.

- For maximum defrost performance, set the temperature control knob to the highest temperature setting (rotated all the way to the right) and the fan speed control to the highest setting.
- If warm air to the floor is desired while defrosting or defogging, set the mode to the floor-defrost position.
- Before driving, clear all snow and ice from the windshield, rear window, side view mirrors, and all side windows.
- Clear all snow and ice from the hood and air inlet in the cowl grill to improve heater and defroster efficiency and to reduce the probability of fogging up inside of the windshield.

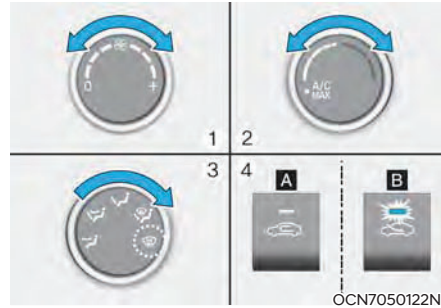
### Manual climate control system To defog inside windshield



[A] : Type A, [B] : Type B

1. Select any fan speed except “0” position.
2. Select the desired temperature.
3. Select the  or  position.
4. Fresh mode air will be selected automatically. Additionally, the air conditioning (if equipped) will automatically operate if the mode is selected to the  position.

If the air conditioning and fresh mode are not selected automatically, press the corresponding button manually.

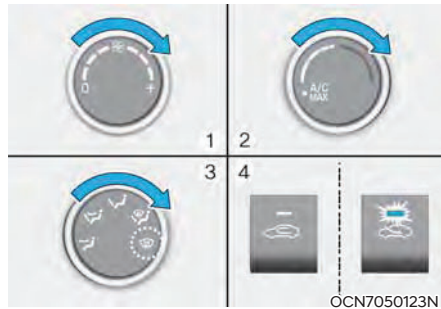

**To defrost outside windshield**

[A] : Type A, [B] : Type B

1. Set the fan speed to the highest setting (knob rotated all the way to the right).
2. Set the temperature control to the highest temperature setting.
3. Select the  position.
4. Fresh mode air and air conditioning (if equipped) will be selected automatically.

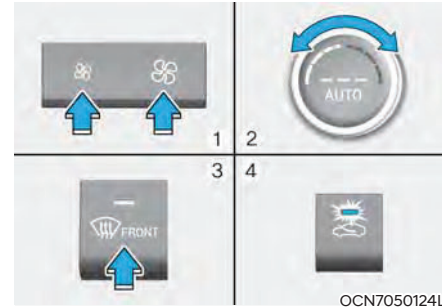
**Automatic climate control system****To defog inside windshield**

1. Select desired fan speed.
2. Select desired temperature.
3. Press the defroster button ().
4. The air-conditioning will turn on according to the detected ambient temperature, fresh mode and higher fan speed will be selected automatically.

If the air-conditioning, fresh mode and higher fan speed are not selected automatically, adjust the corresponding button or knob manually.

If the  position is selected, lower fan speed is controlled to higher fan speed.

**To defrost outside windshield**

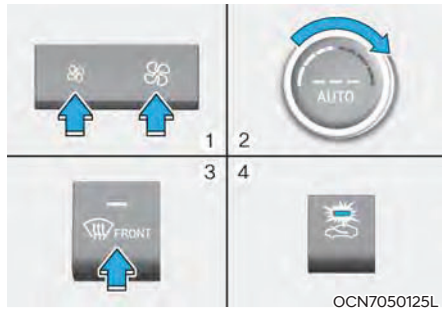

1. Set fan speed to the highest position.
2. Set temperature to the extreme hot (HI) position.
3. Press the defroster button (☀️).
4. The air-conditioning will turn on according to the detected ambient temperature and fresh mode will be selected automatically.

If the ☀️ position is selected, lower fan speed is controlled to higher fan speed.

**Defogging logic (if equipped)**

To help reduce the probability of fogging up the inside of the windshield, the air intake or air conditioning are controlled automatically according to certain conditions such as ☀️ or ☀️ position. To cancel or return the defogging logic, do the following

**Manual climate control system**

1. Turn the ignition switch to the ON position.
2. Select defroster mode (☀️).
3. Press the air intake control button at least 5 times within 3 seconds. The process should be completed within 10 seconds after the defroster mode (☀️) is selected.

The LED indicator on the air intake button will blink 3 times to indicate that the defogging logic has been disabled.

Repeat the steps again to re-enable the defogging logic.

If the battery has been discharged or disconnected, it resets to the defog logic status.

**Automatic climate control system**

1. Turn the ignition switch to the ON position.
2. Press the defroster button (☀️).
3. While pressing the air conditioning button (A/C), press the air intake control button at least 5 times within 3 seconds.

The automatic climate control information screen will blink 3 times to indicate that the defogging logic has been disabled.

Repeat the steps again to re-enable the defogging logic.

If the battery has been discharged or disconnected, it resets to the defog logic status.

### Auto defogging system (only for automatic climate control system, if equipped)

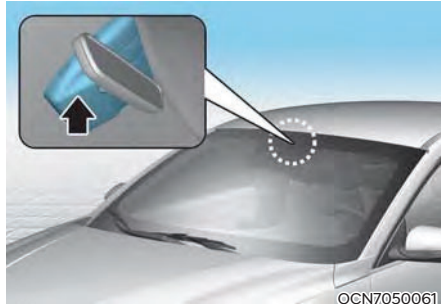

Auto defogging helps reduce the possibility of fogging up the inside of the windshield by automatically sensing the moisture on inside the windshield.

The auto defogging system operates when the heater or air conditioning is on.



When the Auto Defogging System operates, the indicator will illuminate.

If a high amount of humidity is detected in the vehicle, the Auto Defogging System will be enabled.

The following steps will be performed automatically:

- Step 1) The A/C button will turn ON.
- Step 2) The air intake control will change to Fresh mode under low outside temperature.
- Step 3) The mode will be changed to defrost to direct airflow to the windshield.
- Step 4) The fan speed will be increased.

### To cancel or reset the Auto Defogging System

Press the front windshield defroster button for 3 seconds when the ignition switch is in the ON position.

When the Auto Defogging System is canceled, defrost button indicator will blink 3 times.

When the Auto Defogging System is reset, defrost button indicator will blink 6 times without a signal.

### **i** Information

- **When the air conditioning is turned on by Auto defogging system, if you try to turn off the air conditioning, the indicator will blink 3 times and the air conditioning will not be turned off.**
- **To maintain the effectiveness and efficiency of the Auto Defogging System, do not select Recirculation mode while the system is operating.**
- **When the Auto Defogging System is operating, the fan speed adjustment knob, the temperature adjustment knob, and the air intake control button are all disabled.**

### **NOTICE**

**Do not remove the sensor cover located on the upper end of the driver side windshield glass.**

**Damage to system parts could occur and may not be covered by your vehicle warranty.**

## Defroster

### NOTICE

To prevent damage to the conductors bonded to the inside surface of the rear window, never use sharp instruments or window cleaners containing abrasives to clean the window.

### **i** Information

If you want to defrost and defog the front windshield, refer to “Windshield Defrosting and Defogging” in this chapter.

#### Rear window defroster

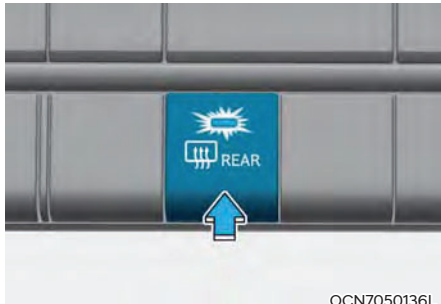

OCN7050136L

The defroster heats the window to remove frost, fog and thin ice from the interior and exterior of the rear window, while engine is running.

- To activate the rear window defroster, press the rear window defroster button located in the center facia switch panel. The indicator on the rear window defroster button illuminates when the defroster is ON.
- To turn off the defroster, press the rear window defroster button again.

### **i** Information

- If there is heavy accumulation of snow on the rear window, brush it off before operating the rear defroster.
- The rear window defroster automatically turns off after approximately 20 minutes or when the ignition switch is in the LOCK/OFF position.

#### Outside mirror defroster (if equipped)

If your vehicle is equipped with the outside mirror defrosters, they will operate at the same time you turn on the rear window defroster.

## CLIMATE CONTROL ADDITIONAL FEATURES

### Sunroof inside air recirculation (if equipped)

When the sunroof is opened, outside (fresh) air will be automatically selected. At this time, if you press the air intake control button, recirculated air position will be selected but will change back to outside (fresh) air after 3 minutes. When the sunroof is closed, the air intake position will return to the original position that was selected.

### Auto comfort control (for driver's seat) (if equipped)

The temperature of the driver's seat warmer, air ventilation seat and heated steering wheel is automatically controlled depending on the inside and outside temperature of the vehicle when the engine is running.

To use this function, it must be activated from the Settings menu in the Infotainment system screen. Select:

- All menus → Setup → Vehicle → Heated / Ventilated Features

**For more details on Auto Comfort Control, refer to “Seat warmers and air ventilation seat” in chapter 3, and “Heated steering wheel” in chapter 5**

### Automatic ventilation (if equipped)

The system automatically selects the fresh mode when the climate control system operates over a certain period of time (approximately 30 minutes) in low temperature with the recirculation mode selected.

#### ***To cancel or reactivate the Automatic Ventilation***

When the air conditioning system is on, select Face Level  mode and press the air recirculation mode button at least 5 times within 3 seconds while pressing the A/C button.

When the automatic ventilation is canceled, the indicator blinks 3 times. When the automatic ventilation is activated, the indicator blinks 6 times.

## STORAGE COMPARTMENT

### WARNING

Never store cigarette lighters, propane cylinders, or other flammable/explosive materials in the vehicle. These items may catch fire and/or explode if the vehicle is exposed to hot temperatures for extended periods.

### WARNING

ALWAYS keep the storage compartment covers closed securely while driving. Items inside your vehicle are moving as fast as the vehicle. If you have to stop or turn quickly, or if there is a crash, the items may fly out of the compartment and may cause an injury if they strike the driver or a passenger.

### **NOTICE**

To avoid possible theft, do not leave valuables in the storage compartments.

## Center console storage

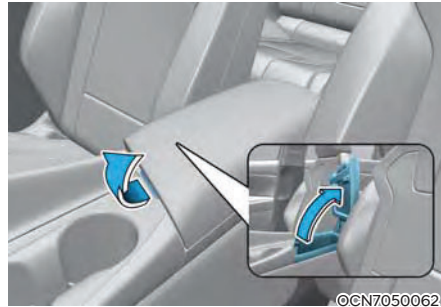

To open:

Grab and hold the latch on the armrest then lift the lid.

## Glove box

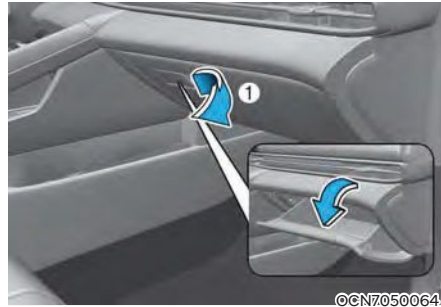

To open:

Pull the lever (1).

### WARNING

ALWAYS close the glove box door after use.

An open glove box door can cause serious injury to the passenger in an accident, even if the passenger is wearing a seat belt.

## INTERIOR FEATURES

### Cup Holder (if equipped)

#### Front



#### Rear



Cups or small beverages cups may be placed in the cup holders.

#### WARNING

- Avoid abrupt starting and braking when the cup holder is in use to prevent spilling your drink. If hot liquid spills, you could be burned. Such a burn to the driver could cause loss of vehicle control resulting in an accident.
- Do not place uncovered or unsecured cups, bottles, cans, etc., in the cup holder containing hot liquid while the vehicle is in motion. Injuries may result in the event of a sudden stop or collision.
- Only use soft cups in the cup holders. Hard objects can injure you in an accident.

#### WARNING

Keep cans or bottles out of direct sun light and do not put them in a hot vehicle. It may explode.

#### NOTICE

- Keep your drinks sealed while driving to prevent spilling your drink. If liquid spills, it may get into the vehicle's electrical/electronic system and damage electrical/electronic parts.
- When cleaning spilled liquids do not use hot air to blow out or dry the cup holder. This may damage the interior.

### Sunvisor

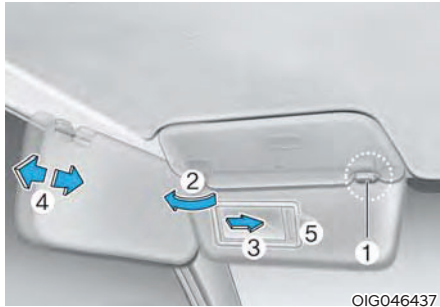

To use a sunvisor, pull it downward.

To use a sunvisor for a side window, pull it downward, unsnap it from the bracket (1) and swing it to the side (2).

To use the vanity mirror, pull down the sunvisor and slide the mirror cover (3).

Adjust the sunvisor forward or backward (4, if equipped) as needed.

Use the ticket holder (5) to hold tickets.

Close the vanity mirror cover securely and return the sunvisor to its original position after use.

#### NOTICE

Close the vanity mirror cover securely and return the sunvisor to its original position after use.



#### WARNING

For your safety, do not block your view when using the sunvisor.

#### NOTICE

Do not put several tickets in the ticket holder at one time. This could cause damage to the ticket holder.

### Power Outlet



The power outlet is designed to provide power for mobile telephones or other devices designed to operate with vehicle electrical systems. The devices should draw less than 180 W with the engine running.



#### WARNING

Avoid electrical shocks. Do not place your fingers or foreign objects (pin, etc.) into a power outlet or touch the power outlet with a wet hand.



**NOTICE**

To prevent damage to the Power Outlets:

- Use the power outlet only when the engine is running and remove the accessory plug after use. Using the accessory plug for prolonged periods of time with the engine off could cause the battery to discharge.
- Only use 12V electric accessories which are less than 180 W in electric capacity.
- Adjust the air-conditioner or heater to the lowest operating level when using the power outlet.
- Close the cover when not in use.
- Some electronic devices can cause electronic interference when plugged into a vehicle's power outlet. These devices may cause excessive audio static and malfunctions in other electronic systems or devices used in your vehicle.
- Push the plug in as far as it will go. If good contact is not made, the plug may overheat and the fuse may open.
- Plug in battery equipped electrical/electronic devices with reverse current protection. The current from the battery may flow into the vehicle's electrical/electronic system and cause system malfunction.

**USB Charger**

Insert the USB charger into the USB port, and re-charge a smart phone or a tablet PC.

- A charging status/charging completion message is displayed on a screen of a smart phone or a tablet PC.
- A smart phone or a tablet PC may get warmer during the re-charging process. It does not indicate any malfunction with the charging system.
- A smart phone or a tablet PC, which adopts a different re-charging method, may not be properly re-charged. In this case, use an exclusive charger of your device.
- The charging terminal is only to recharge a device. Do not use the charging terminal either to turn ON an audio or to play media on the infotainment system.

### Wireless Cellular Phone Charging System (if equipped)



[A] : Charging pad

There is a wireless cellular phone charger inside the front console.

The system is available when all doors are closed, and when the ignition switch is in the ON position.

### ***To charge a cellular phone***

The wireless cellular phone charging system charges only the Qi-enabled cellular phones. Read the label on the cellular phone accessory cover or visit your cellular phone manufacturer's website to check whether your cellular phone supports the Qi technology.

The wireless charging process starts when you put a Qi-enabled cellular phone on the wireless charging unit.

1. Remove other items, including the smart key, from the wireless charging unit. If not, the wireless charging process may be interrupted. Place the cellular phone on the center of the charging pad (  ).
2. When charging starts, a charging icon is displayed on the infotainment system screen. However, depending on the infotainment system screen, the wireless charging icon may not be displayed. See the infotainment web manual for details.
3. You can turn ON or OFF the wireless charging function in the user settings mode on the instrument cluster. For further information, refer to the "LCD Display Modes" in this chapter.

The system warns you with a message on the LCD display if the cellular phone is still on the wireless charging unit after the engine is turned OFF and the front door is opened.

### **i** Information

For some manufacturers' cellular phones, the system may not warn you even though the cellular phone is left on the wireless charging unit. This is due to the particular characteristic of the cellular phone and not a malfunction of the wireless charging.

### **NOTICE**

- The wireless cellular phone charging system may not support certain cellular phones, which are not verified for the Qi specification ( Qi ).
  - When placing your cellular phone on the charging mat, position the phone in the middle of the mat for optimal charging performance. If your cellular phone is off to the side, the charging rate may be less and in some cases the cellular phone may experience higher heat conduction.
  - In some cases, the wireless charging may stop temporarily when the Remote Key or Smart Key is used, either when starting the vehicle or locking/unlocking the doors, etc.
  - The wireless charging process may temporarily stop, when temperature abnormally increases inside the wireless cellular phone charging system. Stop the charging cellular phone and wait until temperature falls to a certain level.
  - The wireless charging process may temporarily stop when there is any metallic item, such as a coin, between the wireless cellular phone charging system and the cellular phone.
- When charging some cellular phones with a self-protection feature, the wireless charging speed may decrease and the wireless charging may stop.
  - If the cellular phone has a thick cover, the wireless charging may not be possible.
  - If the cellular phone is not completely contacting the charging pad, wireless charging may not operate properly.
  - Some magnetic items like credit cards, phone cards or rail tickets may be damaged if left with the cellular phone during the charging process.
  - When any cellular phone without a wireless charging function or a metallic object is placed on the charging pad, a small noise may sound. This small sound is due to the vehicle discerning compatibility of the object placed on the charging pad. It does not affect your vehicle or the cellular phone in any way.

### **i** Information

If the ignition switch is in the LOCK/ OFF position, the charging also stops.

### **i** Information

This device complies with part 15 of the FCC Rules.

Operation is subject to the following two conditions:

1. This device may not cause harmful interference, and
2. This device must accept any interference received, including interference that may cause undesired operation.

### Clock



#### WARNING

Do not attempt to adjust the clock while driving. Doing so may result in distracted driving which may lead to an accident involving personal injury or death.

For more information, please refer to the manual that was supplied with your vehicle.

### Clothes Hanger



These hangers are not designed to hold large or heavy items.



#### WARNING

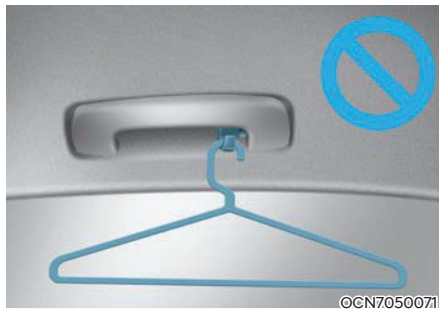

Do not hang other objects such as hangers or hard objects except clothes. Also, do not put heavy, sharp or breakable objects in the clothes pockets. In an accident or when the curtain air bag is inflated, it may cause vehicle damage or personal injury.

## INFOTAINMENT SYSTEM

### NOTICE

- If you install an aftermarket HID head lamp, your vehicle's audio and electronic devices may not function properly.
- Prevent chemicals such as perfume, cosmetic oil, sunscreen, hand cleaner, and air freshener from contacting the interior parts because they may cause damage or discoloration.

### USB Port



You can use a USB port to plug in a USB.

### **i** Information

When using a portable audio device connected to the power outlet, noise may occur during playback. If this happens, use the power source of the portable audio device.

## Antenna

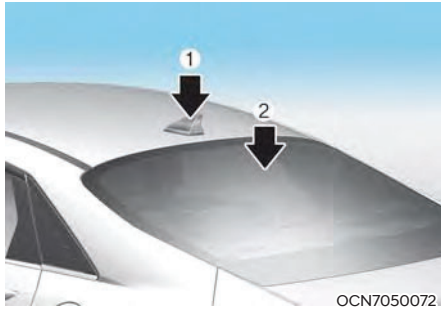

### ***Shark fin antenna (1, if equipped)***

The shark fin antenna receives data transmitted from base stations and satellites (for example: GPS, Sirius XM, LTE) and also transmits to base stations (for example: LTE).

### ***Glass antenna (2)***

Your vehicle uses a glass antenna to receive both AM and FM signals.

## **WARNING**

- Do not clean the inside of the rear window glass with a cleaner or scraper to remove foreign deposits as this may cause damage to the antenna elements.
- To prevent damage to the rear glass antenna, never use sharp instruments or window cleaner containing abrasives to clean the window. Clean the inside surface of the rear glass window with a piece of soft cloth.
- Avoid adding metallic coatings such as Nickel, Cadmium, etc. These can degrade the receiving AM and FM broadcast signals.
- When putting a sticker on the inside surface of the rear window, be careful not to damage the rear glass antenna.
- Do not put sharp instruments nearby the rear glass antenna.
- Tinted rear window may affect the proper functioning of the antenna.

## Steering wheel audio control



The steering wheel audio control switches are installed for your convenience.

### NOTICE

**Do not operate audio remote control buttons simultaneously.**

#### **VOLUME (VOL + / VOL -) (1)**

- Move the VOLUME toggle switch up to increase volume.
- Move the VOLUME toggle switch down to decrease volume.

#### **SEEK/PRESET (∧ / ∨) (2)**

If the SEEK/PRESET toggle switch is moved up or down and held for 0.8 second or more, it will function in the following modes.

- **RADIO mode**  
It will function as the AUTO SEEK select switch. It will SEEK until you release the switch.
- **MEDIA mode**  
It will function as the FF/REW switch. If the SEEK/PRESET toggle switch is moved up or down, it will function in the following modes.
- **RADIO mode**  
It will function as the PRESET STATION UP/DOWN switch.
- **MEDIA mode**  
It will function as the TRACK UP/DOWN switch.

#### **MODE (○)(3)**

Press the MODE button to select Radio.

#### **Voice recognition button (🗣️) (4)**

- Start or end voice recognition of a connected smartphone via phone projection. (The button's operation may vary depending on smartphone specifications.)

### **i** Information

**Detailed information for audio control buttons are described in the following pages in this chapter.**

### Infotainment system (if equipped)

If your vehicle is equipped with additional navigation, please refer to the infotainment system manual separately supplied.

### Voice recognition (if equipped)

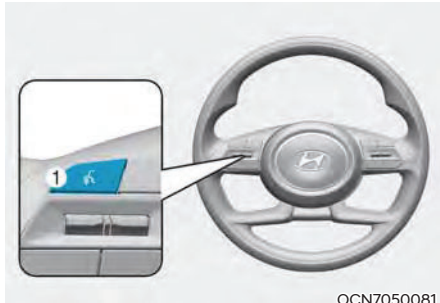

A wide range of infotainment functions can be commanded with voice recognition.

**If your vehicle is equipped with additional navigation, please refer to the infotainment system manual separately supplied.**

### Bluetooth® Wireless Technology hands-free (if equipped)

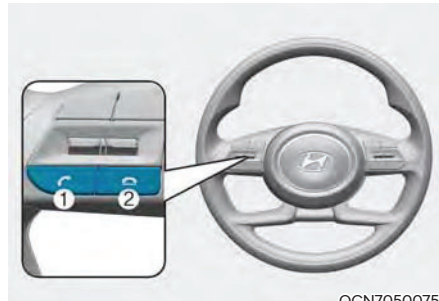

You can use the phone wirelessly by using the Bluetooth® Wireless Technology.

- (1) Call / Answer button
- (2) Call end button
- (3) LHD Microphone
- (4) RHD Microphone

- Audio : For detailed information, refer to "AUDIO" in this chapter.
- Navigation : Detailed information for the Bluetooth® Wireless Technology hands-free is described in the manual supplied separately



## How vehicle radio works

### FM reception

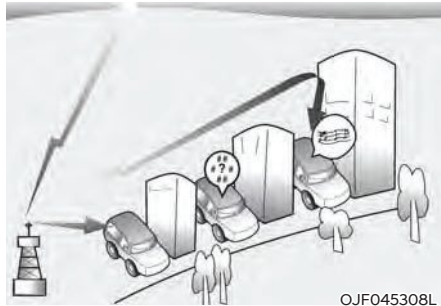

AM and FM radio signals are broadcast from transmitter towers located around your city. They are intercepted by the radio antenna on your vehicle. This signal is then received by the radio and sent to your vehicle speakers.

When a strong radio signal has reached your vehicle, the precise engineering of your audio system ensures the best possible quality reproduction. However, in some cases the signal coming to your vehicle may not be strong and clear.

This can be due to factors, such as the distance from the radio station, closeness of other strong radio stations or the presence of buildings, bridges or other large obstructions in the area.

### AM (MW, LW) reception

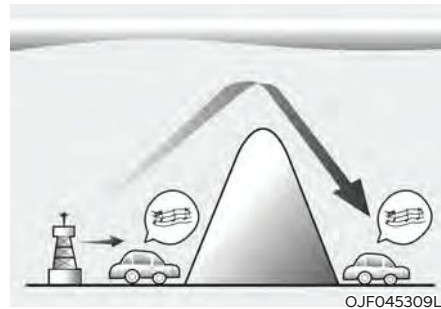

AM broadcasts can be received at greater distances than FM broadcasts. This is because AM radio waves are transmitted at low frequencies. These long, low frequency radio waves can follow the curvature of the earth rather than travelling straight out into the atmosphere. In addition, they curve around obstructions so that they can provide better signal coverage.

**FM radio station**

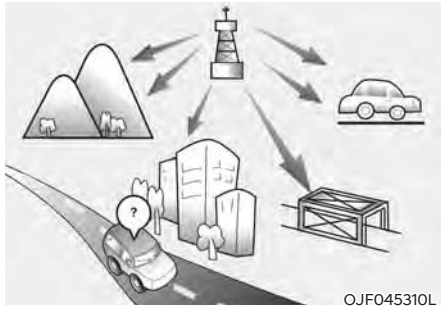

FM broadcasts are transmitted at high frequencies and do not bend to follow the earth's surface. Because of this, FM broadcasts generally begin to fade at short distances from the station. Also, FM signals are easily affected by buildings, mountains, or other obstructions.

These can result in certain listening conditions which might lead you to believe a problem exists with your radio. The following conditions are normal and do not indicate radio trouble :

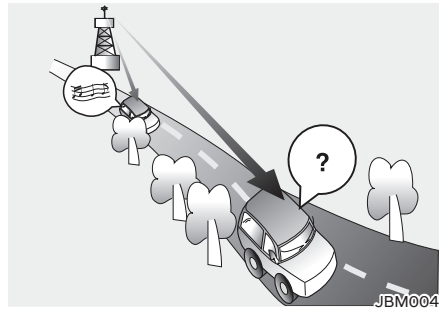

- Fading as your vehicle moves away from the radio station, the signal will weaken and sound will begin to fade. When this occurs, we suggest that you select another stronger station.
- Flutter/Static Weak FM signals or large obstructions between the transmitter and your radio can disturb the signal causing static or fluttering noises to occur. Reducing the treble level may lessen this effect until the disturbance clears.

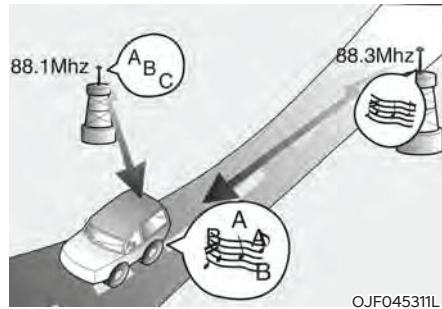

- **Station Swapping** As a FM signal weakens, another more powerful signal near the same frequency may begin to play. This is because your radio is designed to lock onto the clearest signal. If this occurs, select another station with a stronger signal.
- **Multi-Path Cancellation** Radio signals being received from several directions can cause distortion or fluttering. This can be caused by a direct and reflected signal from the same station, or by signals from two stations with close frequencies. If this occurs, select another station until the condition has passed.

### ***Using a cellular phone or a twoway radio***

When a cellular phone is used inside the vehicle, noise may be produced from the audio system. This does not mean that something is wrong with the audio equipment. In such a case, use the cellular phone at a place as far as possible from the audio equipment.

#### **NOTICE**

**When using a communication system such as a cellular phone or a radio set inside the vehicle, a separate external antenna must be fitted. When a cellular phone or a radio set is used with an internal antenna alone, it may interfere with the vehicle's electrical system and adversely affect safe operation of the vehicle.**



#### **WARNING**

**Do not use a cellular phone while driving. Stop at a safe location to use a cellular phone.**

## 6. While Driving

---

Before Driving .....	6-4
Before Entering the Vehicle.....	6-4
Before Starting .....	6-4
Ignition Switch .....	6-5
Key Ignition Switch.....	6-5
Engine Start/Stop Button .....	6-8
Manual transmission .....	6-13
Manual transmission operation.....	6-13
Good driving practices.....	6-15
Intelligent variable transmission.....	6-16
Intelligent variable transmission operation.....	6-16
Parking .....	6-21
Good driving practices.....	6-22
Dual clutch transmission.....	6-23
Dual clutch transmission operation .....	6-23
LCD display for transmission temperature and warning message.....	6-25
Paddle Shifter (Manual Shift Mode) .....	6-30
Parking .....	6-32
Good driving practices.....	6-32
Brake System.....	6-34
Power Brakes .....	6-34
Disc Brakes Wear Indicator.....	6-34
Parking brake.....	6-35
Electronic Parking Brake (EPB).....	6-37
Auto Hold .....	6-41
Anti-lock Brake System (ABS) .....	6-44
Electronic Stability Control (ESC) .....	6-46
Vehicle Stability Management (VSM) .....	6-48
Hill-Start Assist Control (HAC) .....	6-49
Good Braking Practices .....	6-49
ISG (Idle Stop and Go) system.....	6-50
To Activate the ISG System.....	6-50
To Deactivate the ISG System .....	6-52
ISG System Malfunction .....	6-52
Battery Sensor Deactivation.....	6-53

---

---

Drive Mode Integrated Control System.....	6-54
Drive Mode .....	6-54
Smart shift on trip computer .....	6-57
Special Driving Conditions.....	6-58
Hazardous Driving Conditions .....	6-58
Rocking the Vehicle .....	6-58
Smooth Cornering.....	6-59
Driving at Night .....	6-59
Driving in the Rain.....	6-59
Driving in Flooded Areas.....	6-60
Highway Driving .....	6-60
Winter Driving .....	6-61
Snow or Icy Conditions .....	6-61
Winter Precautions.....	6-63
Vehicle load limit.....	6-64
Tire Loading Information Label .....	6-65
Trailer Towing .....	6-69

**WARNING**

**Carbon monoxide (CO) gas is toxic. Breathing CO can cause unconsciousness and death.**

Engine exhaust contains carbon monoxide which cannot be seen or smelled.

**Do not inhale engine exhaust.**

If at any time you smell engine exhaust inside the vehicle, open the windows immediately. Exposure to CO can cause unconsciousness and death by asphyxiation.

**Be sure the exhaust system does not leak.**

The exhaust system should be checked whenever the vehicle is raised to change the oil or for any other purpose. If you hear a change in the sound of the exhaust or if you drive over something that strikes the underneath side of the vehicle, have the exhaust system checked as soon as possible by an authorized HYUNDAI dealer.

**Do not run the engine in an enclosed area.**

Letting the engine idle in your garage, even with the garage door open, is a hazardous practice. Run the engine only long enough to start the engine and to move the vehicle out of the garage.

**Avoid idling the engine for prolonged periods with people inside the vehicle.**

If it is necessary to idle the engine for a prolonged period with people inside the vehicle, be sure to do so only in an open area with the air intake set at "Fresh" and fan control set to high so fresh air is drawn into the interior.

**Keep the air intakes clear.**

To assure proper operation of the ventilation system, keep the ventilation air intakes located in front of the windshield clear of snow, ice, leaves, or other obstructions.

**If you must drive with the trunk open:**

Close all windows.

Open instrument panel air vents.

Set the air intake control at "Fresh", the air flow control at "Floor" or "Face", and the fan control set to high.

**WARNING****CALIFORNIA PROPOSITION 65 WARNING**

**Engine exhaust and a wide variety of automobile components including components found in the interior furnishings in a vehicle, contain or emit harmful chemicals known to the State of California to cause cancer and birth defects and reproductive harm. In addition, certain fluids contained in vehicles and certain products of components contain or emit chemicals known to the State of California to cause cancer and birth defects or other reproductive harm.**

## BEFORE DRIVING

### Before Entering the Vehicle

- Be sure all windows, outside mirror(s), and outside lights are clean and unobstructed.
- Remove frost, snow, or ice.
- Visually check the tires for uneven wear and damage.
- Check under the vehicle for any sign of leaks.
- Be sure there are no obstacles behind you if you intend to back up.

### Before Starting

- Make sure the hood, the trunk, and the doors are securely closed and locked.
- Adjust the position of the seat and steering wheel.
- Adjust the inside and side view mirrors.
- Verify all the lights work.
- Fasten your seatbelt. Check that all passengers have fastened their seatbelts.
- Check the gauges and indicators in the instrument panel and the messages on the instrument display when the ignition switch is in the ON position.
- Check that any items you are carrying are stored properly or fastened down securely.

### WARNING

To reduce the risk of **SERIOUS INJURY** or **DEATH**, take the following precautions:

- **ALWAYS** wear your seat belt. All passengers must be properly belted whenever the vehicle is moving. For more information, refer to "Seat Belts" in chapter 3.
- Always drive defensively. Assume other drivers or pedestrians may be careless and make mistakes.
- Stay focused on the task of driving. Driver distraction can cause accidents.
- Leave plenty of space between you and the vehicle in front of you.

### WARNING

**NEVER** drink alcohol or take drugs and drive.

**Drinking alcohol or taking drugs and driving is dangerous and may result in an accident and SERIOUS INJURY or DEATH.**

**Drunk driving is the number one contributor to the highway death toll each year. Even a small amount of alcohol will affect your reflexes, perceptions and judgment. Just one drink can reduce your ability to respond to changing conditions and emergencies and your reaction time gets worse with each additional drink.**

**Driving while under the influence of drugs is as dangerous or more dangerous than driving under the influence of alcohol.**

**You are much more likely to have a serious accident if you drink or take drugs and drive. If you are drinking or taking drugs, don't drive. Do not ride with a driver who has been drinking or taking drugs. Choose a designated driver or call a taxi.**

## IGNITION SWITCH

### Key Ignition Switch (if equipped)



#### WARNING

To reduce the risk of **SERIOUS INJURY** or **DEATH**, take the following precautions:

- **NEVER** allow children or any person who is unfamiliar with the vehicle to touch the ignition switch or related parts. Unexpected and sudden vehicle movement can occur.
- **NEVER** reach through the steering wheel for the ignition switch, or any other control, while the vehicle is in motion. The presence of your hand or arm in this area may cause a loss of vehicle control resulting in an accident.

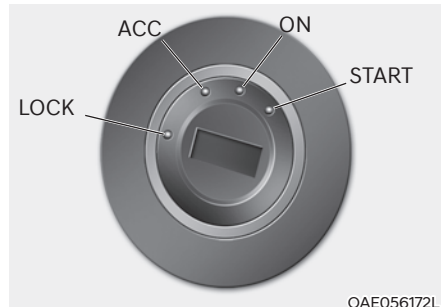

OAE056172L

Whenever the front door is opened, the ignition switch will illuminate, provided the ignition switch is not in the ON position. The light will go off immediately when the ignition switch is turned on or go off after about 30 seconds when the door is closed. (if equipped)



#### WARNING

**NEVER** turn the ignition switch to the **LOCK** or **ACC** position while the vehicle is in motion except in an emergency. This will result in the engine turning off and loss of power assist for the steering and brake systems. This may lead to loss of directional control and braking function, which could cause an accident.

Before leaving the driver's seat, always make sure the shift button is in **P (Park)** position, apply the parking brake, and turn ignition switch to the **LOCK** position.

Unexpected vehicle movement may occur if these precautions are not followed.



**Key ignition switch positions**

Switch Position	Action	Notice
<b>LOCK</b>	To turn the ignition switch to the LOCK position, put the key in at the ACC position and turn the key towards the LOCK position. The ignition key can be removed in the LOCK position.	
<b>ACC</b>	Electrical accessories are usable. The steering wheel unlocks.	
<b>ON</b>	This is the normal key position when the engine has started. All features and accessories are usable. The warning lights can be checked when you turn the ignition switch from ACC to ON.	Do not leave the ignition switch in the ON position when the engine is not running in order to prevent the battery from discharging.
<b>START</b>	To start the engine, turn the ignition switch to the START position. The switch returns to the ON position when you let go of the key.	The engine will crank until you release the key.

### *Starting the engine*



#### **WARNING**

Always wear appropriate shoes when operating your vehicle.

Unsuitable shoes, such as high heels, ski boots, sandals, flip-flops, etc., may interfere with your ability to use the brake and accelerator pedals.

Vehicle with manual transmission:

1. Make sure the parking brake is applied.
2. Make sure the shift lever is in neutral.
3. Depress the clutch and brake pedals.
4. Turn the ignition switch to the START position. Hold the key (maximum of 10 seconds) until the engine starts and release it.



#### **Information**

Depress the brake pedal and clutch pedal until the engine starts.

Vehicle with intelligent variable transmission:

1. Make sure the parking brake is applied.
2. Make sure the shift lever is in P (Park).
3. Depress the brake pedal.
4. Turn the ignition switch to the START position. Hold the key (maximum of 10 seconds) until the engine starts and release it.



#### **Information**

- It is best to maintain a moderate engine speed until the vehicle engine comes up to normal operating temperature. Avoid harsh or abrupt acceleration or deceleration while the engine is still cold.
- Whether the engine is cold or warm, always start the vehicle with your foot on the brake pedal. Do not depress the accelerator while starting the vehicle. Do not rev the engine while warming it up.

#### **NOTICE**

To prevent damage to the vehicle:

- Do not hold the ignition key in the START position for more than 10 seconds. Wait 5 to 10 seconds before trying again.
- Do not push or tow your vehicle to start the engine.

### *Turning off the engine*

1. Stop the vehicle and depress the brake pedal fully.
2. Shift the gear to P (Park).
3. Turn the ignition switch to the off position and apply the parking brake.

### Engine Start/Stop Button (if equipped)



Whenever the front door is opened, the Engine Start/Stop button will illuminate and will go off 30 seconds after the door is closed. (if equipped)

#### **WARNING**

To reduce risk of serious injury or death, **NEVER** allow children or any person who is unfamiliar with the vehicle to touch the Engine Start/Stop button or related parts. Unexpected and sudden vehicle movement can occur.

#### **WARNING**

To turn the engine off in an emergency: Press and hold the Engine Start/Stop button for more than two seconds OR rapidly press and release the Engine Start/Stop button three times (within three seconds).

If the vehicle is still moving, you can restart the engine without depressing the brake pedal by pressing the Engine Start/Stop button with the shift button in the N (Neutral) position.

#### **WARNING**

- **NEVER** press the Engine Start/Stop button while the vehicle is in motion except in an emergency. This will result in the engine turning off and loss of power assist for the steering and brake systems. This may lead to loss of directional control and braking function, which could cause an accident.
- Before leaving the driver's seat, always make sure the shift button is in the P (Park) position, set the parking brake, press the Engine Start/Stop button to the OFF position, and take the Smart Key with you. Unexpected vehicle movement may occur if these precautions are not followed.
- **NEVER** reach through the steering wheel for the Engine Start/Stop button or any other control while the vehicle is in motion. The presence of your hand or arm in this area may cause a loss of vehicle control resulting in an accident.

**Engine Stop/Start button positions**

Button Position	Action	Notice
<b>OFF</b>	To turn off the engine, press the Engine Start/Stop button with shift button in P (Park). When you press the Engine Start/Stop button without the shift button in P (Park), the Engine Start/Stop button does not turn to the OFF position, but turns to the ACC position.	
<b>ACC</b>	Press the Engine Start/Stop button when the button is in the OFF position without depressing the brake pedal. Electrical accessories are usable.	If you leave the Engine Start/Stop button in the ACC position for more than one hour, the battery power will turn off automatically to prevent the battery from discharging.
<b>ON</b>	Press the Engine Start/Stop button while it is in the ACC position without depressing the brake pedal. The warning lights can be checked before the engine is started.	Do not leave the Engine Start/Stop button in the ON position when the engine is not running to prevent the battery from discharging.
<b>START</b>	To start the engine, depress the brake pedal and press the Engine Start/Stop button with the shift button in the P (Park) or in the N (Neutral) position. For your safety, start the engine with the shift button in the P (Park) position.	If you press the Engine Start/Stop button without depressing the brake pedal, the engine does not start and the Engine Start/Stop button changes as follows: <b>OFF → ACC → ON → OFF or ACC</b> However, the engine may start if you depress the brake pedal within 0.5 second after pressing the Engine Start/Stop button from the OFF position.

### Starting the engine



#### WARNING

- Always wear appropriate shoes when operating your vehicle.  
Unsuitable shoes, such as high heels, ski boots, sandals, flip-flops, etc., may interfere with your ability to use the brake and accelerator pedals.
- Do not start the vehicle with the accelerator pedal depressed. The vehicle can move and lead to an accident.
- Wait until the engine rpm is normal. The vehicle may suddenly move if the brake pedal is released when the rpm is high.



#### Information

- The engine will start by pressing the Engine Start/Stop button, only when the smart key is in the vehicle.
- Even if the smart key is in the vehicle, if it is far away from the driver, the engine may not start.
- When the Engine Start/Stop button is in the ACC or ON position, if any door is open, the system checks for the smart key. If the smart key is not in the vehicle, the “” indicator will blink and the warning "Key not in vehicle" will come on and if all doors are closed, the chime will also sound for about 5 seconds. Keep the smart key in the vehicle when using the ACC position or if the vehicle engine is ON.

Vehicle with manual transmission:

1. Always carry the smart key with you.
2. Make sure the parking brake is applied.
3. Make sure the shift lever is in neutral.
4. Depress the clutch and brake pedals.
5. Press the Engine Start/Stop button.



#### Information

**Depress the brake pedal and clutch pedal until the engine starts.**

Vehicle with intelligent variable transmission:

1. Always carry the smart key with you.
2. Make sure the parking brake is applied.
3. Make sure the shift lever is in P (Park).
4. Depress the brake pedal.
5. Press the Engine Start/Stop button.



#### Information

- Do not wait for the engine to warm up while the vehicle remains stationary. Start driving at moderate engine speeds. (Aggressive accelerating and decelerating should be avoided.)
- Always start the vehicle with your foot on the brake pedal. Do not depress the accelerator while starting the vehicle. Do not rev the engine while warming it up.

**NOTICE**

To prevent damage to the vehicle:

- If the engine stalls while you are in motion, do not attempt to move the shift button to the P (Park) position.

If traffic and road conditions permit, you may put the shift button in the N (Neutral) position while the vehicle is still moving and press the Engine Start/Stop button in an attempt to restart the engine.

- Do not push or tow your vehicle to start the engine.

**NOTICE**

To prevent damage to the vehicle:

When the stop lamp switch fuse is blown, you can't start the engine normally. Replace the fuse with a new one. If you are not able to replace the fuse, you can start the engine by pressing and holding the Engine Start/Stop button for 10 seconds with the Engine Start/Stop button in the ACC position.

Do not press the Engine Start/Stop button for more than 10 seconds except when the stop lamp switch fuse is blown.

For your safety always depress the brake pedal before starting the engine.

**i** Information

If the smart key battery is weak or the smart key does not work correctly, you can start the engine by pressing the Engine Start/Stop button with the smart key in the direction of the picture above.

### ***Auto shut-off system (if equipped)***

To prevent accidents caused by carbon dioxide poisoning, the engine is turned off automatically 60 minutes later when the following conditions are satisfied. The timer appears on the instrument cluster 30 minutes before it turns off automatically.

#### **Operating conditions**

- The driver does not fasten a seat belt
- No one in the passenger's seat
- Stop the vehicle and the speed is under 1.86mph and the gear shift is in P
- While the brake or accelerator is not working
- When AVN update is performing

#### **Cluster timer reset conditions**

- Release the accelerator or brake after completing operation
- Press the OK button on the steering wheel while the timer appears on the instrument cluster

#### **Off conditions**

- The driver fastened the seat belt
- A passenger is in the passenger's seat
- Driving over 1.86mph
- Shifting the gear in R, N or D



#### **CAUTION**

**Please do not leave a passenger or a pet in the vehicle since the air conditioning system stops when the engine is off.**

## MANUAL TRANSMISSION (IF EQUIPPED)

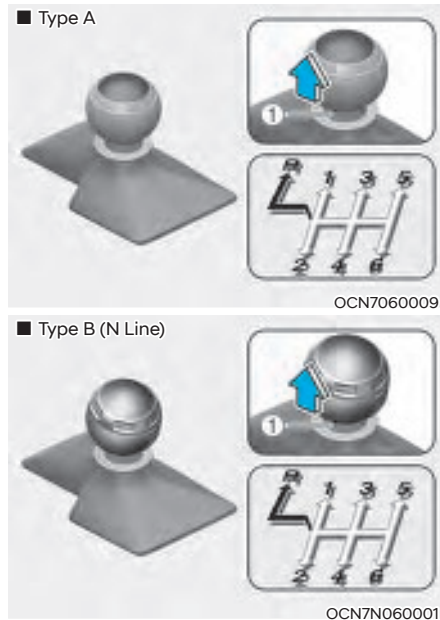

- ⇨ The shift lever can be moved without pressing the button (1).
- ➔ The button (1) must be pressed while moving the shift lever.

### Manual transmission operation

The manual transmission has 6 forward gears. The transmission is fully synchronized in all forward gears so shifting to either a higher or a lower gear is easily accomplished.

### WARNING

- Before leaving the driver's seat, always make sure the shift lever is in 1st gear when the vehicle is parked on a uphill and in R (Reverse) on a downhill, set the parking brake, and place the ignition switch in the LOCK/OFF position. Unexpected vehicle movement may occur if these precautions are not followed.
- When parking on an incline, block the wheels to prevent the vehicle from rolling down.

To shift to R (Reverse), make sure the vehicle has completely stopped, and then move the shift lever to neutral before moving into R (Reverse).

When you've come to a complete stop and it's hard to shift into 1st gear or R (Reverse):

1. Put the shift lever in neutral and release the clutch pedal.
2. Depress the clutch pedal, and then shift into first or R (Reverse) gear.

### Information

During cold weather, shifting may be difficult until the transmission lubricant has warmed up.

### Using the clutch

The clutch pedal should be depressed all the way before:

- Starting the engine
  - The engine will not start without depressing the clutch pedal.
- Shifting into gear, up shifting to the next higher gear, or down shifting to the next low gear.

When releasing the clutch pedal, release it slowly. The clutch pedal should always be fully released while driving.



**NOTICE**

To prevent unnecessary wear or damage to the clutch:

- Do not rest your foot on the clutch pedal while driving.
- Do not hold the vehicle with the clutch on an incline, while waiting for the traffic light, etc.
- Always depress the clutch pedal down fully to prevent noise or damage.
- Do not start with the 2nd (second) gear engaged except when you start on a slippery road.
- Do not drive with cargo loaded more than the recommended loading capacity.
- Make sure to depress the clutch pedal until the engine starts completely. If you release the clutch pedal before the engine starts completely, the engine may stop.

**Downshifting**

Down shift to a lower gear when slowing down in heavy traffic or driving up a steep hill to prevent high engine loads.

Also, downshifting reduces the chance of stalling and helps to reaccelerate the vehicle when you need to increase your speed.

When the vehicle is going downhill, downshifting helps maintain safe speed by providing a load from the engine and results in less wear on the brakes.

**NOTICE**

To prevent damage to the engine, clutch and transmission:

- When downshifting from 5th gear to 4th gear, be careful not to inadvertently push the shift lever sideways engaging the 2nd gear. A drastic downshift may cause the engine speed to increase to the point the tachometer will enter the red-zone and may cause engine damage.
- Do not downshift more than two gears at a time or downshift the gear when the engine is running at high speed (5,000 RPM or higher). Such downshifting may damage the engine, clutch and the transmission.

### Good driving practices

- Never take the vehicle out of gear and coast down a hill. This is extremely dangerous.
- Don't "ride" the brakes. This can cause the brakes and related parts to overheat and malfunction.
- When you are driving down a long hill, slow down and shift to a lower gear. Engine braking will help slow down the vehicle.
- Slow down before shifting to a lower gear. This will help avoid over-revving the engine, which can cause damage.
- Slow down when you encounter cross winds. This gives you much better control of your vehicle.
- Be sure the vehicle is completely stopped before you shift into R (Reverse) to prevent damage to the transmission.
- Exercise extreme caution when driving on a slippery surface. Be especially careful when braking, accelerating or shifting gears. On a slippery surface, an abrupt change in vehicle speed can cause the drive wheels to lose traction and may cause loss of vehicle control resulting in an accident.

### WARNING

**Do not use the engine brake (shifting from a higher gear to lower gear) rapidly on slippery roads. The vehicle may slip causing an accident.**

### WARNING

**To reduce the risk of SERIOUS INJURY or DEATH:**

- **ALWAYS wear your seat belt. In a collision, an unbelted occupant is significantly more likely to be seriously injured or killed than a properly belted occupant.**
- **Avoid high speeds when cornering or turning.**
- **Do not make quick steering wheel movements, such as sharp lane changes or fast, sharp turns.**
- **The risk of rollover is greatly increased if you lose control of your vehicle at highway speeds.**
- **Loss of control often occurs if two or more wheels drop off the roadway and the driver over steers to reenter the roadway.**
- **In the event your vehicle leaves the roadway, do not steer sharply. Instead, slow down before pulling back into the travel lanes.**
- **HYUNDAI recommends you follow all posted speed limits.**

## INTELLIGENT VARIABLE TRANSMISSION (IF EQUIPPED)

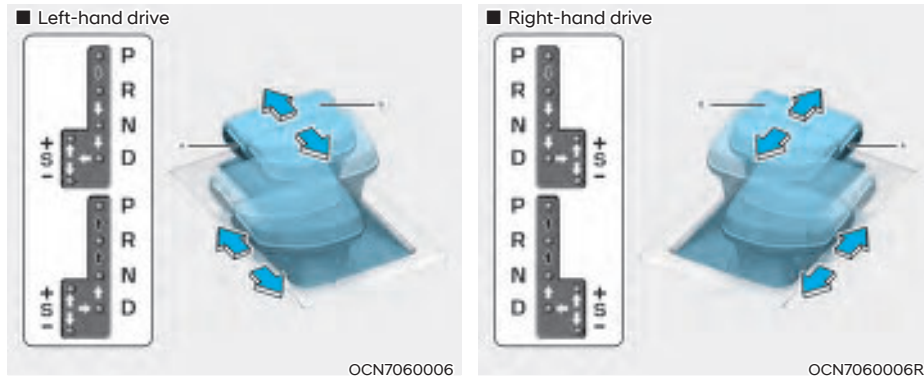

- ▣ Depress the brake pedal and press the shift button while moving the shift lever.
- ➡ Press the shift button while moving the shift lever.
- ⇨ The shift lever can freely operate.

### Intelligent variable transmission operation

The Intelligent Variable Transmission (IVT) automatically shifts depending on speed and accelerate pedal position. The individual speeds are selected automatically, depending on the position of the shift lever.

**WARNING**

To reduce the risk of serious injury or death:

- **ALWAYS** check the surrounding areas near your vehicle for people, especially children, before shifting a vehicle into D (Drive) or R (Reverse).
- Before leaving the driver's seat, always make sure the shift lever is in the P (Park) position, then set the parking brake, and place the ignition switch in the LOCK/OFF position. Unexpected and sudden vehicle movement can occur if these precautions are not followed.
- When using Manual Shift Mode, do not use engine braking (shifting from a high gear to lower gear) rapidly on slippery roads. The vehicle may slip causing an accident.

**Transmission ranges**

The indicator in the instrument cluster displays the shift lever position when the ignition switch is in the ON position.

**P (Park)**

Always come to a complete stop before shifting into P (Park).

To shift from P (Park), you must depress firmly on the brake pedal and make sure your foot is off the accelerator pedal.

**If you have done all of the above and still cannot shift the lever out of P (Park), see "Shift-Lock Release" in this chapter.**

The shift lever must be in P (Park) before turning the engine off.

**WARNING**

- Shifting into P (Park) while the vehicle is in motion may cause you to lose control of the vehicle.
- After the vehicle has stopped, always make sure the shift lever is in P (Park), apply the parking brake, and turn the engine off.
- When parking on an incline, block the wheels to prevent the vehicle from rolling down.
- Do not use the P (Park) position in place of the parking brake.
- The RPM (revolution per minute) may increase or decrease when performing the Intelligent Variable Transmission (IVT) self-diagnosis.

### R (Reverse)

Use this position to drive the vehicle backward.

#### **NOTICE**

**Always come to a complete stop before shifting into or out of R (Reverse); you may damage the transmission if you shift into R (Reverse) while the vehicle is in motion.**

### N (Neutral)

The wheels and transmission are not engaged.

Use N (Neutral) if you need to restart a stalled engine, or if it is necessary to stop with the engine ON. Shift into P (Park) if you need to leave your vehicle for any reason.

Always depress the brake pedal when you are shifting from N (Neutral) to another gear.



#### **WARNING**

**Do not shift into gear unless your foot is firmly on the brake pedal. Shifting into gear when the engine is running at high speed can cause the vehicle to move very rapidly. You could lose control of the vehicle and hit people or objects.**

### D (Drive)

This is the normal driving position. The transmission will automatically shift, providing the best fuel economy and power. For extra power when passing another vehicle or driving uphill depress the accelerator pedal further until you feel the transmission downshift to a lower gear.

The DRIVE MODE switch, located on the shift lever console, allows the driver to switch from NORMAL mode to ECO or SPORT mode (if equipped).

**For more information, refer to "Drive Mode Integrated Control System" later in this chapter.**

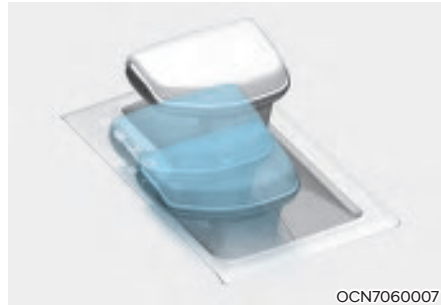

#### DS mode (Drive Sporty)

- To shift into Ds mode, move the shift lever from D (Drive) to the center of the manual shift mode. The engine and transmission control logic is automatically optimized for sporty driving.
- In Ds mode, if you move the shift lever to + (up) or (down), the gear will change to manual shift mode. If the shift lever is moved back into D (Drive), it will change to D (Drive). The vehicle will perform according to the mode selected from drive mode (NORMAL, SPORT, SMART).

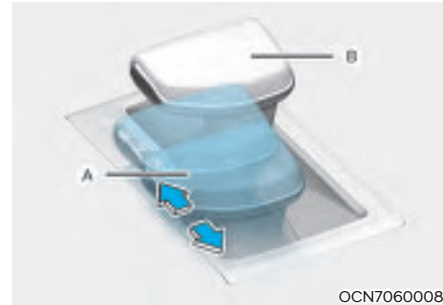

#### Manual shift mode

Whether the vehicle is stationary or in motion, manual shift mode is selected by pushing the shift lever from the D (Drive) position into the manual gate. To return to D (Drive) range operation, push the shift lever back into the main gate.

In manual shift mode, moving the shift lever backwards and forwards will allow you to select the desired range of gears for the current driving conditions.

- + (Up) : Push the lever forward once to shift up one gear.
- (Down) : Pull the lever backwards once to shift down one gear.

**i** Information

- Only the six forward gears can be selected. To reverse or park the vehicle, move the shift lever to the R (Reverse) or P (Park) position as required.
- Downshifts are made automatically when the vehicle slows down. When the vehicle stops, 1st gear is automatically selected.
- When the engine rpm approaches the red zone the transmission will upshift automatically.
- If the driver presses the lever to + (Up) or - (Down) position, the transmission may not make the requested gear change if the next gear is outside of the allowable engine rpm range. The driver must execute upshifts in accordance with road conditions, taking care to keep the engine rpms below the red zone.
- When driving on a slippery road, push the shift lever forward into the + (Up) position. This causes the transmission to shift into the 2nd gear which is better for smooth driving on a slippery road. Push the shift lever to the - (Down) side to shift back to the 1st gear.
- When driving in manual shift mode, slow down before shifting to a lower gear. Otherwise, the lower gear may not be engaged if the engine rpms are outside of the allowable range.

**Shift-lock system**

For your safety, the Intelligent variable transmission has a shift-lock system which prevents shifting the transmission from P (Park) into R (Reverse) unless the brake pedal is depressed.

To shift the transmission from P (Park) into R (Reverse):

1. Depress and hold the brake pedal.
2. Start the engine or place the ignition switch in the ON position.
3. Move the shift lever.

### Shift-lock release

If the shift lever cannot be moved from the P (Park) position into R (Reverse) position with the brake pedal depressed, continue depressing the brake, and then do the following:



1. Place the ignition switch in the LOCK/OFF position.
2. Apply the parking brake.
3. Carefully remove the shift lever boots.
4. Move the shift lever while holding the release button (1) with a tool (e.g. flathead screw-driver).

If you need to use the shift-lock release, we recommend that the system be inspected by an authorized HYUNDAI dealer immediately.

### CAUTION

Be careful not to damage the trim beside of the shift lever while removing the shift lever boots.

### Ignition key interlock system (if equipped)

The ignition key cannot be removed unless the shift lever is in the P (Park) position.

### Parking

Always come to a complete stop and continue to depress the brake pedal. Move the shift lever into the P (Park) position, apply the parking brake, and place the ignition switch in the LOCK/OFF position. Take the Key with you when exiting the vehicle.

### WARNING

- When you stay in the vehicle with the engine running, be careful not to depress the accelerator pedal for a long period of time. The engine or exhaust system may overheat and start a fire.
- The exhaust gas and the exhaust system are very hot. Keep away from the exhaust system components.
- Do not stop or park over flammable materials, such as dry grass, paper or leaves. They may ignite and cause a fire.



### Good driving practices

- Never move the shift lever from P (Park) or N (Neutral) to any other position with the accelerator pedal depressed.
- Never move the shift lever into P (Park) when the vehicle is in motion.
- Be sure the vehicle is completely stopped before you attempt to shift into R (Reverse) or D (Drive).
- Do not move the shift lever to N (Neutral) when driving. Doing so may result in an accident because of a loss of engine braking and the transmission could be damaged.
- When driving uphill or downhill, always shift to D (Drive) for driving forward or shift to R (Reverse) for driving backwards, and check the gear position indicated on the cluster before driving. Driving in the opposite direction of the selected gear, can lead to a dangerous situation by shutting off the engine and affecting the braking performance.
- Do not drive with your foot resting on the brake pedal. Even light, but consistent pedal pressure can result in the brakes overheating, brake wear and possibly even brake failure.
- Do not hold the vehicle on an incline with the accelerator pedal. This can cause the transmission to overheat. Always use the brake pedal or parking brake.
- Always apply the parking brake when leaving the vehicle. Do not depend on placing the transmission in P (Park) to keep the vehicle from moving.
- Exercise extreme caution when driving on a slippery surface. Be especially careful when braking, accelerating or shifting gears. On a slippery surface, an abrupt change in vehicle speed can cause the drive wheels to lose traction and may cause loss of vehicle control resulting in an accident.
- Optimum vehicle performance and economy is obtained by smoothly depressing and releasing the accelerator.



### WARNING

To reduce the risk of **SERIOUS INJURY** or **DEATH**:

- **ALWAYS wear your seat belt. In a collision, an unbelted occupant is significantly more likely to be seriously injured or killed than a properly belted occupant.**
- **Avoid high speeds when cornering or turning.**
- **Do not make quick steering wheel movements, such as sharp lane changes or fast, sharp turns.**
- **The risk of rollover is greatly increased if you lose control of your vehicle at highway speeds.**
- **Loss of control often occurs if two or more wheels drop off the roadway and the driver over steers to reenter the roadway.**
- **In the event your vehicle leaves the roadway, do not steer sharply. Instead, slow down before pulling back into the travel lanes.**
- **HYUNDAI recommends you follow all posted speed limits.**

## DUAL CLUTCH TRANSMISSION (IF EQUIPPED)

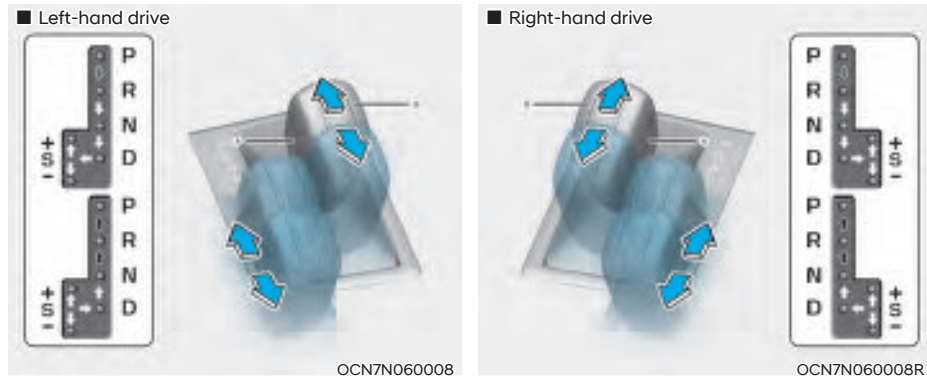

- ⚡ Depress the brake pedal and press the shift button while moving the shift lever.
- ➡ Press the shift button while moving the shift lever.
- ⇨ The shift lever can freely operate.

### Dual clutch transmission operation

The dual clutch transmission has 7 forward speeds and one reverse speed. The individual speeds are selected automatically in the D (Drive) position.



## WARNING

To reduce the risk of serious injury or death:

- **ALWAYS** check the surrounding areas near your vehicle for people, especially children, before shifting a vehicle into D (Drive) or R (Reverse).
  - Before leaving the driver's seat, always make sure the shift lever is in the P (Park) position, then set the parking brake, and place the ignition switch in the LOCK/OFF position. Unexpected and sudden vehicle movement can occur if these precautions are not followed.
  - When using Manual Shift Mode, do not use engine braking (shifting from a high gear to lower gear) rapidly on slippery roads. The vehicle may slip causing an accident.
  - To avoid damage to your transaxle, do not try to accelerate in R (Reverse) or any forward gear position with the brakes on.
  - When stopped on slope, do not hold the vehicle with accelerator pedal. Use the service brake or the parking brake.
- The dual clutch transmission can be thought of as an automatically shifting manual transmission. It gives the driving feel of a manual transmission, yet provides the ease of a fully automatic transmission.
  - When D (Drive) is selected, the transmission will automatically shift through the gears similar to a conventional automatic transmission. Unlike a traditional automatic transmission, the gear shifting can sometimes be felt and heard as the actuators engage the clutches and the gears are selected.
  - The dual clutch transmission adopts a dry-type dual clutch, which is different from the torque converter of the automatic transmission. It shows better acceleration performance and increased fuel efficiency while driving but initial launch might be little bit slower than the automatic transmission.  
As a result, gear shifts are sometimes more noticeable than a conventional automatic transmission and a light vibration during launching can be felt as the transmission speed. This is a normal condition of the dual clutch transmission.
  - The dry-type clutch transfers torque more directly and provides a direct drive feeling which may feel different from a conventional automatic transmission. This may be more noticeable when launching the vehicle from a stop or when traveling at low, stop-and-go vehicle speeds.
  - When rapidly accelerating at a low vehicle speed, the engine rpm may increase highly depending on the vehicle's driving condition.
  - For smooth launch uphill, press down the accelerator pedal smoothly depending on the current conditions.

- If you release your foot from the accelerator pedal at low vehicle speed, you may feel strong engine braking, which is similar to manual transmission.
- When driving downhill, you may use Sports Mode or press the paddle shifters (if equipped) to downshift to a lower gear in order to control your speed without using the brake pedal excessively.
- When you turn the engine on and off, you may hear clicking sounds as the system goes through a self-test. This is a normal sound for the dual clutch transmission.
- During the first 1000 miles (1,500 km), you may feel that the vehicle may not be smooth when accelerating at low speed. During this break-in period, the shift quality and performance of your new vehicle is continuously optimized.



### WARNING

**Due to transmission failure, you may not continue to drive and the position indicator (D, R) on the cluster will blink. We recommend you to contact an authorized HYUNDAI dealer and have the system checked.**

## LCD display for transmission temperature and warning message

### DCT warning messages

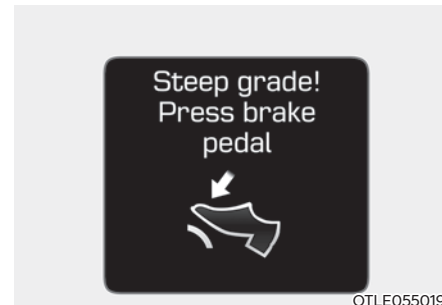

OTLE055019

This warning message is displayed when vehicle is driven slowly on a grade and the vehicle detects that the brake pedal is not applied.

### Steep grade

Driving up hills or on steep grades:

- To hold the vehicle on an incline use the foot brake or the parking brake.
- When in stop-and-go traffic on an incline, keep some distance ahead before moving the vehicle forward. Then hold the vehicle on the incline with the foot brake.
- If the vehicle is held on a hill by applying the accelerator pedal or by creeping with brake pedal disengaged, the clutch and transmission may overheat which can result in damage. At this time, a warning message will appear on the LCD display.
- If the LCD warning is active, the foot brake must be applied.
- Ignoring the warnings can lead to damage to the transmission.

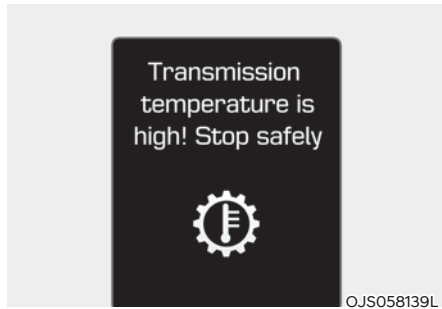

**Transmission high temperature**

- Under certain conditions, such as repeated stop-and-go launches on steep grades, sudden take off or acceleration, or other harsh driving conditions, the transmission clutch temperatures will increase excessively. Finally the clutch in transmission could be overheated.
- When the clutch is overheated, the safe protection mode engages and the gear position indicator on the cluster blinks with a chime. At this time, "Transmission temperature is high! Stop safely" warning message will appear on the LCD display and driving may not be smooth.

- If this occurs, pull over to a safe location, stop the vehicle with the engine running, apply the brakes and shift the vehicle to P (Park), and allow the transmission to cool.
- If you ignore this warning, the driving condition may become worse. You may experience abrupt shifts, frequent shifts, or jerkiness. To return to the normal driving condition, stop the vehicle and apply the foot brake or shift into P (Park). Then allow the transmission to cool for a few minutes with engine on, before driving off.
- When possible, drive the vehicle smoothly.

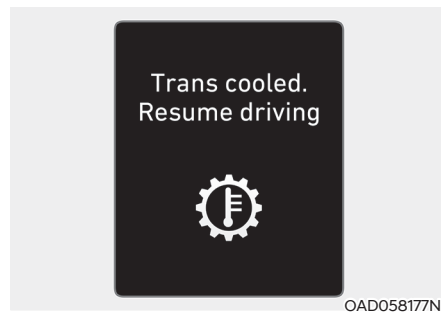
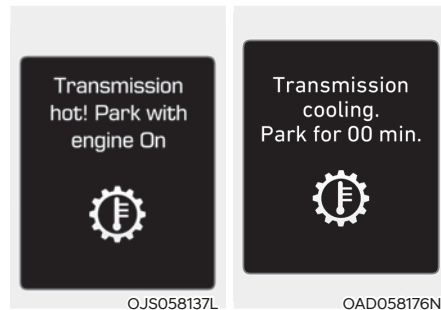

**Transmission overheated**

- If the vehicle continues to be driven and the clutch temperatures reach the maximum temperature limit, the "Transmission hot! Park with engine On" warning will be displayed. When this occurs the clutch is disabled until the clutch cools to normal temperatures.
- The warning will display a time to wait for the transmission to cool.
- If this occurs, pull over to a safe location, stop the vehicle with the engine running, apply the brakes and shift the vehicle to P (Park), and allow the transmission to cool.
- When the message "Transmission cooled down. Resume driving" appears you can continue to drive your vehicle.
- When possible, drive the vehicle smoothly.

If any of the warning messages in the LCD display continue to blink, for your safety, we recommend you contact an authorized HYUNDAI dealer and have the system checked.

**Transmission ranges**

The indicator in the instrument cluster displays the shift lever position when the ignition switch is in the ON position.

**P (Park)**

Always come to a complete stop before shifting into P (Park).

To shift from P (Park), you must depress firmly on the brake pedal and make sure your foot is off the accelerator pedal.

**If you have done all of the above and still cannot shift the lever out of P (Park), see "Shift-Lock Release" in this chapter.**

The shift lever must be in P (Park) before turning the engine off.

**WARNING**

- **Shifting into P (Park) while the vehicle is in motion may cause you to lose control of the vehicle.**
- **After the vehicle has stopped, always make sure the shift lever is in P (Park), apply the parking brake, and turn the engine off.**
- **Do not use the P (Park) position in place of the parking brake.**

### R (Reverse)

Use this position to drive the vehicle backward.

#### **NOTICE**

**Always come to a complete stop before shifting into or out of R (Reverse); you may damage the transaxle if you shift into R (Reverse) while the vehicle is in motion.**

### N (Neutral)

The wheels and transaxle are not engaged.

Use N (Neutral) if you need to restart a stalled engine, or if it is necessary to stop with the engine ON. Shift into P (Park) if you need to leave your vehicle for any reason.

Always depress the brake pedal when you are shifting from N (Neutral) to another gear.

### D (Drive)

This is the normal driving position. The transmission will automatically shift through a 7-gear sequence, providing the best fuel economy and power.

For extra power when passing another vehicle or driving uphill, depress the accelerator fully. The transmission will automatically downshift to the next lower gear (or gears, as appropriate).

The DRIVE MODE switch, located on the shift lever console, allows the driver to switch from NORMAL mode to ECO or SPORT mode (if equipped)

**For more information, refer to "Drive Mode Integrated Control System" later in this chapter.**



#### **WARNING**

- **Do not shift into gear unless your foot is firmly on the brake pedal. Shifting into gear when the engine is running at high speed can cause the vehicle to move very rapidly. You may lose control of the vehicle and cause accidents.**
- **Do not drive with the shift lever in N (Neutral). The engine brake will not work and may lead to an accident.**

#### **NOTICE**

**Always make sure the vehicle is stationary, at a complete stop, before selecting D (Drive).**

**DS mode (Drive Sporty)**

To shift into Ds mode, move the shift lever from D (Drive) to the center of the manual shift mode. The engine and transmission control logic is automatically optimized for sporty driving.

In Ds mode, if you move the shift lever to + (up) or (down), the gear will change to manual shift mode. If the shift lever is moved back into D (Drive), it will change to D (Drive). The vehicle will perform according to the mode selected from drive mode (NORMAL, ECO, SPORT, SMART).

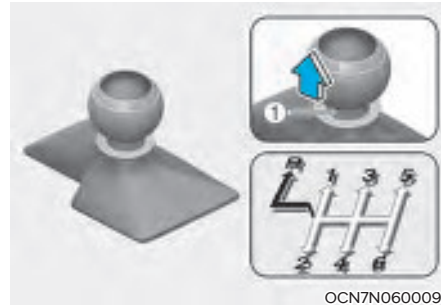

OCN7N060009

**Manual shift mode**

Whether the vehicle is stationary or in motion, sports mode is selected by pushing the shift lever from the D (Drive) position into the manual gate. To return to D (Drive) range operation, push the shift lever back into the main gate.

In manual shift mode, moving the shift lever backwards and forwards will allow you to select the desired range of gears for the current driving conditions.

Up (+): Push the lever forward once to shift up one gear.

Down (-): Pull the lever backwards once to shift down one gear.



**i** Information

- Only the seven forward gears can be selected. To reverse or park the vehicle, move the shift lever to the R (Reverse) or P (Park) position as required.
- Downshifts are made automatically when the vehicle slows down. When the vehicle stops, 1st gear is automatically selected.
- When the engine rpm approaches the red zone the transmission will upshift automatically.
- If the driver presses the lever to + (Up) or - (Down) position, the transmission may not make the requested gear change if the next gear is outside of the allowable engine rpm range. The driver must execute upshifts in accordance with road conditions, taking care to keep the engine rpms below the red zone.

**Paddle Shifter (Manual Shift Mode) (if equipped)**

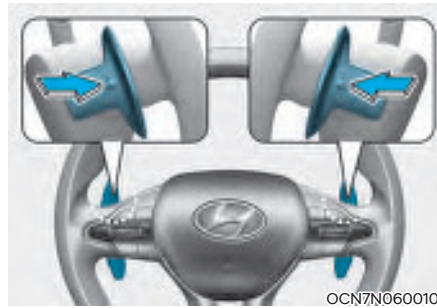

The paddle shifter is available when the gear is in the D (Drive) position.

Pull the [+] or [-] paddle shifter once to shift up or down one gear and the system changes from automatic shift mode to manual shift mode.

To change back to the automatic shift mode from manual shift mode, do one of the following:

- Gently depress the accelerator pedal for more than 5 seconds (Except Sport Mode).
- Drive the vehicle under 6 mph (10 km/h).
- Pull and hold the right side paddle shifter.

**i** Information

**If the [+] and [-] paddle shifters are pulled at the same time, gear shift may not occur.**

### **Shift-lock system**

For your safety, the dual clutch transmission has a shift-lock system which prevents shifting the transmission from P (Park) into R (Reverse) unless the brake pedal is depressed.

To shift the transmission from P (Park) into R (Reverse):

1. Depress and hold the brake pedal.
2. Start the engine or place the ignition switch in the ON position.
3. Move the shift lever.

### **Shift-lock release**

If the shift lever cannot be moved from the P (Park) position into R (Reverse) position with the brake pedal depressed, continue depressing the brake, and then do the following:



1. Place the ignition switch in the LOCK/OFF position
2. Apply the parking brake.
3. Carefully remove the shift lever boots.
4. Move the shift lever while holding the release button (1) with a tool (e.g. flathead screw-driver).

If you need to use the shift-lock release, we recommend that the system be inspected by an authorized HYUNDAI dealer immediately.



### **CAUTION**

**Be careful not to damage the trim beside of the shift lever while removing the shift lever boots.**

### **Ignition key interlock system (if equipped)**

The ignition key cannot be removed unless the shift lever is in the P (Park) position.

### Parking

Always come to a complete stop and continue to depress the brake pedal. Move the shift lever into the P (Park) position, apply the parking brake, and place the ignition switch in the LOCK/OFF position. Take the Key with you when exiting the vehicle.



#### **WARNING**

**When you stay in the vehicle with the engine running, be careful not to depress the accelerator pedal for a long period of time. The engine or exhaust system may overheat and start a fire.**

**The exhaust gas and the exhaust system are very hot. Keep away from the exhaust system components.**

**Do not stop or park over flammable materials, such as dry grass, paper or leaves. They may ignite and cause a fire.**

### Good driving practices

- Never move the shift lever from P (Park) or N (Neutral) to any other position with the accelerator pedal depressed.
- Never move the shift lever into P (Park) when the vehicle is in motion. Be sure the vehicle is completely stopped before you attempt to shift into R (Reverse) or D (Drive).
- Do not move the shift lever to N (Neutral) when driving. Doing so may result in an accident because of a loss of engine braking and the transmission could be damaged.
- When driving uphill or downhill, always shift to D (Drive) for driving forward or shift to R (Reverse) for driving backwards, and check the gear position indicated on the cluster before driving. Driving in the opposite direction of the selected gear, can lead to a dangerous situation by shutting off the engine and affecting the braking performance.
- Do not drive with your foot resting on the brake pedal. Even light, but consistent pedal pressure can result in the brakes overheating, brake wear and possibly even brake failure.
- When driving in sports mode, slow down before shifting to a lower gear. Otherwise, the lower gear may not be engaged if the engine rpms are outside of the allowable range.
- Always apply the parking brake when leaving the vehicle. Do not depend on placing the transmission in P (Park) to keep the vehicle from moving.
- Exercise extreme caution when driving on a slippery surface. Be especially careful when braking, accelerating or shifting gears. On a slippery surface, an abrupt change in vehicle speed can cause the drive wheels to lose traction and may cause loss of vehicle control resulting in an accident.

- Optimum vehicle performance and economy is obtained by smoothly depressing and releasing the accelerator.

**WARNING**

To reduce the risk of **SERIOUS INJURY** or **DEATH**:

- **ALWAYS** wear your seatbelt. In a collision, an unbelted occupant is significantly more likely to be seriously injured or killed than a properly belted occupant.
- Avoid high speeds when cornering or turning.
- Do not make quick steering wheel movements, such as sharp lane changes or fast, sharp turns.
- The risk of rollover is greatly increased if you lose control of your vehicle at highway speeds.
- Loss of control often occurs if two or more wheels drop off the roadway and the driver over steers to reenter the roadway.
- In the event your vehicle leaves the roadway, do not steer sharply. Instead, slow down before pulling back into the travel lanes.
- **HYUNDAI** recommends you follow all posted speed limits.

**WARNING**

If your vehicle is stuck in snow, mud, sand, etc., you may attempt to free the vehicle by rocking it back and forth. Do not attempt this procedure if people or objects are anywhere near. Vehicle may suddenly move forward or backward as it becomes unstuck, causing injury or damage to nearby people or objects.

## BRAKE SYSTEM

### Power Brakes

Your vehicle has power-assisted brakes that adjust automatically through normal usage.

If the engine is not running or is turned off while driving, the power assist for the brakes will not work. You can still stop your vehicle by applying greater force to the brake pedal than typical. The stopping distance, however, will be longer than with power brakes.

When the engine is not running, the reserve brake power is partially depleted each time the brake pedal is applied. Do not pump the brake pedal when the power assist has been interrupted.

Only pump the brakes on slippery surfaces if the power assist has been interrupted to maintain steering control. Do not pump the brakes on slippery surfaces if the brakes are operating normally.



### WARNING

Take the following precautions:

- **Do not drive with your foot resting on the brake pedal. This will create abnormal high brake temperatures, excessive brake lining and pad wear, and increased stopping distances.**
- **When descending down a long or steep hill, move the gear shift button to Manual Shift Mode and manually downshift to a lower gear in order to control your speed without using the brake pedal excessively. Applying the brakes continuously will cause the brakes to overheat and could result in a temporary loss of braking performance.**

- **Wet brakes may impair the vehicle's ability to safely slow down; the vehicle may also pull to one side when the brakes are applied. Applying the brakes lightly will indicate whether they have been affected in this way. Always test your brakes in this fashion after driving through deep water. To dry the brakes, lightly tap the brake pedal to heat up the brakes while maintaining a safe forward speed until brake performance returns to normal. Avoid driving at high speeds until the brakes function correctly.**

### Disc Brakes Wear Indicator

When your brake pads are worn and new pads are required, you will hear a high pitched warning sound from your front or rear brakes. You may hear this sound come and go or it may occur whenever you depress the brake pedal.

Note that some driving conditions or climates may cause a brake squeal when you first apply (or lightly apply) the brakes. This is normal and does not indicate a problem with your brakes.

### NOTICE

**To avoid costly brake repairs, do not continue to drive with worn brake pads.**



### Information

**Always replace brake pads as complete front or rear axle sets.**

### Parking brake (if equipped) Applying the parking brake

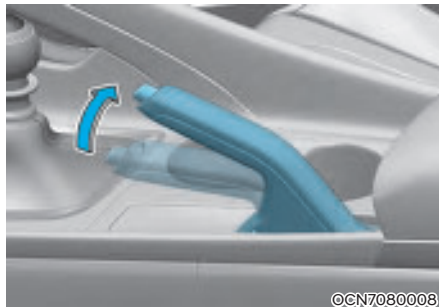

Always set the parking brake before leaving the vehicle, to apply:  
Firmly depress the brake pedal.  
Pull up the parking brake lever as far as possible.



#### **WARNING**

To reduce the risk of **SERIOUS INJURY** or **DEATH**, do not operate the parking brake while the vehicle is moving except in an emergency situation. It could damage the brake system and lead to an accident.

### Releasing the parking brake

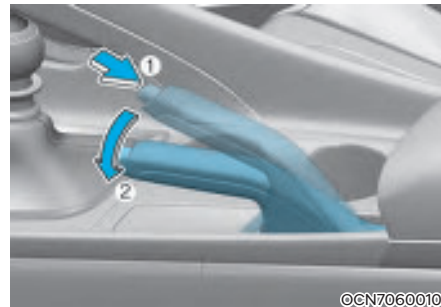

To release:

Firmly depress the brake pedal.  
While pressing the release button (1), slightly pull up on the parking brake lever then lower the parking brake lever (2).



### WARNING

- **Whenever leaving the vehicle or parking, always come to a complete stop and continue to depress the brake pedal. Move the shift lever into the 1st gear (for manual transmission vehicle) or P (Park, for intelligent variable transmission vehicle) position, then apply the parking brake, and place the ignition switch in the LOCK/OFF position.**
- **Vehicles with the parking brake not fully engaged are at risk for moving inadvertently and causing injury to yourself or others.**
- **NEVER allow anyone who is unfamiliar with the vehicle to touch the parking brake. If the parking brake is released unintentionally, serious injury may occur.**
- **Only release the parking brake when you are seated inside the vehicle with your foot firmly on the brake pedal.**

### NOTICE

- **Do not apply the accelerator pedal while the parking brake is engaged. If you depress the accelerator pedal with the parking brake engaged, a warning will sound. Damage to the parking brake may occur.**
- **Driving with the parking brake on can overheat the braking system and cause premature wear or damage to brake parts. Make sure the parking brake is released and the Brake Warning Light is off before driving.**



Check the Parking Brake Warning Light by placing the ignition switch to the ON position (do not start the engine).

This light will be illuminated when the parking brake is applied with the ignition switch in the START or ON position.

Before driving, be sure the parking brake is released and the Brake Warning Light is OFF.

If the Parking Brake Warning Light remains on after the parking brake is released while the engine is running, there may be a malfunction in the brake system. Immediate attention is necessary.

If at all possible, cease driving the vehicle immediately. If that is not possible, use extreme caution while operating the vehicle and only continue to drive the vehicle until you can reach a safe location.



## Electronic Parking Brake (EPB) (if equipped)

### Applying the parking brake



To apply the EPB (Electronic Parking Brake):

1. Depress the brake pedal.
2. Pull up the EPB switch.

  Make sure the parking brake warning light comes on.  
**BRAKE**

### **WARNING**

To reduce the risk of **SERIOUS INJURY** or **DEATH**, do not operate the EPB while the vehicle is moving except in an emergency situation. It could damage the brake system and lead to an accident.

### Releasing the parking brake

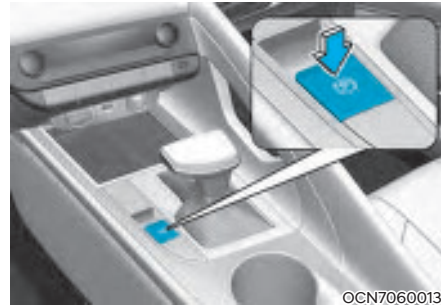

To release the EPB (Electronic Parking Brake), press the EPB switch in the following condition:

- Place the ignition switch in the ON position.
- Depress the brake pedal.

Make sure the Parking Brake Warning Light goes off.

To release EPB (Electronic Parking Brake) automatically:

- Intelligent variable transmission
1. Start the engine.
  2. Close the driver's door, engine hood and trunk.
  3. Depress the accelerator pedal while the shift lever is in R (Reverse) or D (Drive).

Make sure the Parking Brake Warning light goes off.



**i** Information

- For your safety, you can engage the EPB even though the ignition switch is in the OFF position, but you cannot release it.
- For your safety, depress the brake pedal and release the parking brake manually with the EPB switch when you drive downhill or when backing up the vehicle.

**NOTICE**

- If the parking brake warning light is still on even though the EPB has been released, we recommend that the system be checked by an authorized HYUNDAI dealer.
- Do not drive your vehicle with the EPB applied. It may cause excessive brake pad and brake rotor wear.

**EPB (Electronic Parking Brake) may be automatically applied when:**

- Requested by other systems
- The driver turns the engine off while Auto Hold is operating.
- The vehicle is parked on the slope and the Engine Start/Stop button is in the OFF position.
- The Engine is turned off when the driver tries to park but the vehicle still moves a bit.

**Warning messages**

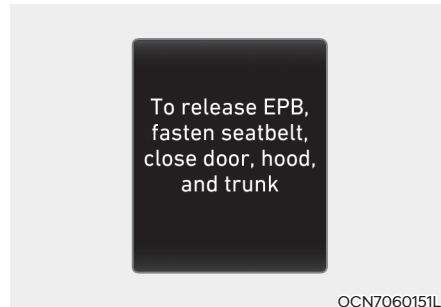

To release EPB, fasten seatbelt, close door, hood and trunk

- If you try to drive with the EPB applied, a warning will sound and a message will appear.
- If the driver's seat belt is unfastened and the engine hood or trunk is opened, a warning will sound and a message will appear.
- If there is a problem with the vehicle, a warning may sound and a message may appear.

If the situation occurs, depress the brake pedal and release EPB by pressing the EPB switch.

### WARNING

- Whenever leaving the vehicle or parking, always come to a complete stop and continue to depress the brake pedal.  
Shift the gear into the P (Park) position, press the EPB switch, and set the ignition switch to the OFF position. Take the Key with you when exiting the vehicle.  
Vehicles not fully engaged in P (Park) with the parking brake set are at risk for moving inadvertently and causing injury to yourself or others.
- NEVER allow anyone who is unfamiliar with the vehicle to touch the EPB switch. If the EPB is released unintentionally, serious injury may occur.
- Only release the EPB when you are seated inside the vehicle with your foot firmly on the brake pedal.

### **NOTICE**

- Do not apply the accelerator pedal while the parking brake is engaged. If you depress the accelerator pedal with the EPB engaged, a warning will sound and a message will appear. Damage to the parking brake may occur.
- Driving with the parking brake on can overheat the braking system and cause premature wear or damage to brake parts. Make sure the EPB is released and the Parking Brake Warning Light is off before driving.

### Information

- A clicking sound may be heard while operating or releasing the EPB. These conditions are normal and indicate that the EPB is functioning properly.
- When leaving your keys with a parking attendant or assistant, make sure to inform him/her how to operate the EPB.

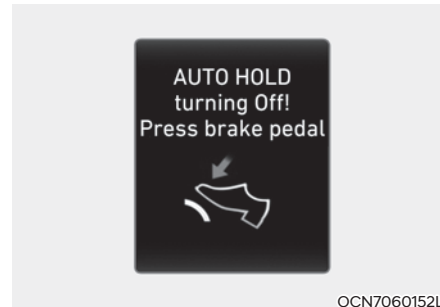

#### **AUTO HOLD turning Off! Press brake pedal**

When the conversion from Auto Hold to EPB is not working properly a warning will sound and a message will appear.

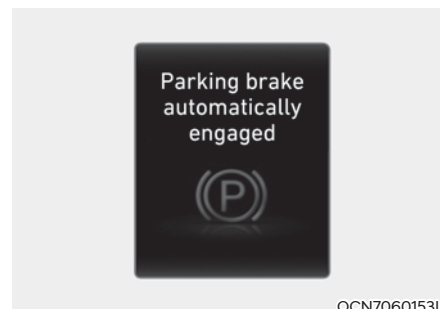

#### **Parking brake automatically engaged**

If the EPB is applied while Auto Hold is activated, a warning will sound and a message will appear.

### **EPB malfunction indicator**



This warning light illuminates if the ignition switch is set to the ON position and goes off in approximately 3 seconds if the system is operating normally.

If the EPB malfunction indicator remains on, comes on while driving, or does not come on when the ignition switch is changed to the ON position, this indicates that the EPB may have malfunctioned.



If this occurs, have the system checked by an authorized HYUNDAI dealer.

The EPB malfunction indicator may illuminate when the ESC indicator comes on to indicate that the ESC is not working properly, but it does not indicate a malfunction of the EPB.

### **NOTICE**

- **If the EPB warning light is still on, have the system checked by an authorized HYUNDAI dealer.**
- **If the parking brake warning light does not illuminate or blinks even though the EPB switch was pulled up, the EPB may not be applied.**
- **If the parking brake warning light blinks when the EPB warning light is on, press the switch, and then pull it up. Repeat this one more time. If the EPB warning does not go off, have the system checked by an authorized HYUNDAI dealer.**

### **Parking brake warning light**

  Check the parking brake warning light by placing the ignition switch to the ON position (do not start the engine).

**BRAKE**

This light will be illuminated when the parking brake is applied with the ignition switch in the START or ON position.

If the parking brake warning light remains on after the parking brake is released while engine is running, there may be a malfunction in the brake system. Immediate attention is necessary.

If at all possible, cease driving the vehicle immediately. If that is not possible, use extreme caution while operating the vehicle and only continue to drive the vehicle until you can reach a safe location.

### Emergency braking

If there is a problem with the brake pedal while driving, emergency braking is possible by pulling up and holding the EPB switch. Braking is possible only while you are holding the EPB switch. However, braking distance will be longer than normal.



#### WARNING

Do not operate the parking brake while the vehicle is moving except in an emergency situation. It could damage the brake system and lead to a severe accident.



#### Information

During emergency braking, the parking brake warning light will illuminate to indicate that the system is operating.

#### NOTICE

If you continuously notice a noise or burning smell when the EPB is used for emergency braking, have system checked by an authorized HYUNDAI dealer.

#### When the EPB (Electronic Parking Brake) does not release

If the EPB does not release normally, contact an authorized HYUNDAI dealer by loading the vehicle on a flatbed tow truck and have the system checked.

### Auto Hold

The Auto Hold maintains the vehicle in a standstill even though the brake pedal is not depressed after the driver brings the vehicle to a complete stop by depressing the brake pedal.

#### To apply :



1. With the driver's door and engine hood closed, depress the brake pedal and then press the [AUTO HOLD] switch. The white AUTO HOLD indicator will come on and the system will be in the standby position.

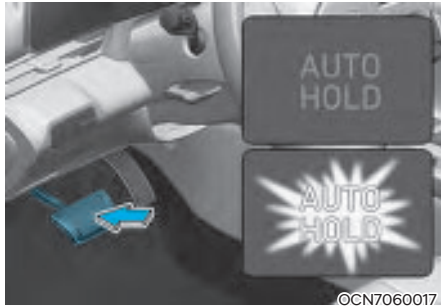

2. When you stop the vehicle completely by depressing the brake pedal, the Auto Hold maintains the brake pressure to hold the vehicle stationary. The indicator changes from white to green.
3. The vehicle will remain stationary even if you release the brake pedal.
4. If EPB is applied, Auto Hold will be released.

**To release :**

- If you press the accelerator pedal with the gear in D (Drive), R (Reverse) or Manual shift mode, the Auto Hold will be released automatically and the vehicle will start to move. The AUTO HOLD indicator changes from green to white.
- If the vehicle is restarted using the cruise control toggle switch (RES+ or SET-) while Auto Hold and cruise control is operating, the Auto Hold will be released regardless of accelerator pedal operation. The AUTO HOLD indicator changes from green to white.

**⚠ WARNING**

When the AUTO HOLD is automatically released by depressing the accelerator pedal, always take a look around your vehicle.

Slowly depress the accelerator pedal for a smooth start.

**To cancel :**



1. Depress the brake pedal.
  2. Press the [AUTO HOLD] switch.
- The AUTO HOLD indicator will turn off.

**⚠ WARNING**

To prevent, unexpected and sudden vehicle movement, ALWAYS press your foot on the brake pedal to cancel the Auto Hold before you:

- Drive downhill.
- Drive the vehicle in R (Reverse).
- Park the vehicle.

**i Information**

- The Auto Hold does not operate when:
  - The driver's door is opened
  - The engine hood is opened in D (Driving) or N (Neutral)
  - The shift lever is in P (Park)
  - The trunk is opened in R (Reverse)
  - The EPB is applied
  - The vehicle stop more than 30 minutes.

- For your safety, the Auto Hold automatically switches to EPB when:
  - The driver's door is opened in D (Driving) or N(Neutral).
  - The engine hood is opened.
  - The trunk is opened in R (Reverse).
  - The vehicle stops for more than 10 minutes
  - The vehicle stands on a steep slope
  - The vehicle moves several times
  - The vehicle stops for more than 30 minutes accumulatively.

In these cases, the parking brake warning light comes on, the AUTO HOLD indicator changes from green to white, and a warning sound and a message will appear to inform you that EPB has been automatically engaged. Before driving off again, press foot brake pedal, check the surrounding area near your vehicle and release parking brake manually with the EPB switch.

- While operating Auto Hold, you may hear mechanical noise. However, it is normal operating noise.

#### NOTICE

If the AUTO HOLD indicator changes to yellow, the Auto Hold is not working properly. Contact an authorized HYUNDAI dealer.



#### WARNING

- Depress the accelerator pedal slowly when you start the vehicle.
- For your safety, cancel the Auto Hold when you drive downhill, back up the vehicle or park the vehicle.

#### NOTICE

If there is a malfunction with the driver's door or engine hood open detection system, the Auto Hold may not work properly.

Contact an authorized HYUNDAI dealer.

#### Warning messages

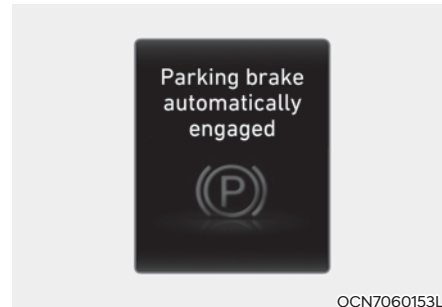

#### Parking brake automatically engaged

When the EPB is applied from Auto Hold, a warning will sound and a message will appear.

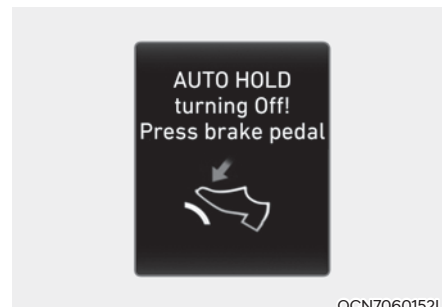

#### AUTO HOLD turning Off! Press brake pedal

When the conversion from Auto Hold to EPB is not working properly a warning will sound and a message will appear.

When this message is displayed, the Auto Hold and EPB may not operate. For your safety, depress the brake pedal.

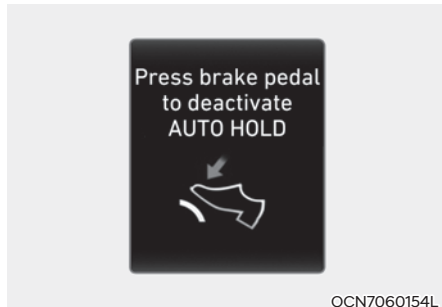

**Press brake pedal to deactivate AUTO HOLD**

If you did not apply the brake pedal when you release the Auto Hold by pressing the [AUTO HOLD] switch, a warning will sound and a message will appear.



**AUTO HOLD conditions not met. Close door, hood and trunk**

When you press the [AUTO HOLD] switch, if the driver's door and engine hood are not closed, a warning will sound and a message will appear on the cluster LCD display.

Press the [AUTO HOLD] switch after closing the driver's door and hood.

## Anti-lock Brake System (ABS)

 **WARNING**

An Anti-Lock Braking System (ABS) or an Electronic Stability Control (ESC) system will not prevent accidents due to improper or dangerous driving maneuvers. Even though vehicle control is improved during emergency braking, always maintain a safe distance between you and objects ahead of you. Vehicle speeds should always be reduced during extreme road conditions. The braking distance for cars equipped with ABS or ESC may be longer than for those without these systems in the following road conditions.

Drive your vehicle at reduced speeds during the following conditions:

- Rough, gravel or snow-covered roads.
- On roads where the road surface is pitted or has different surface height.
- Tire chains are installed on your vehicle.

The safety features of an ABS or ESC equipped vehicle should not be tested by high speed driving or cornering. This could endanger the safety of yourself or others.

ABS is an electronic braking system that helps prevent a braking skid. ABS allows the driver to steer and brake at the same time.

### Using ABS

To obtain the maximum benefit from your ABS in an emergency situation, do not attempt to modulate your brake pressure and do not try to pump your brakes. Depress your brake pedal as hard as possible.

When you apply your brakes under conditions which may lock the wheels, you may hear sounds from the brakes, or feel a corresponding sensation in the brake pedal. This is normal and it means your ABS is active.

ABS does not reduce the time or distance it takes to stop the vehicle.

Always maintain a safe distance from the vehicle in front of you.

ABS will not prevent a skid that results from sudden changes in direction, such as trying to take a corner too fast or making a sudden lane change. Always drive at a safe speed for the road and weather conditions.

ABS cannot prevent a loss of stability. Always steer moderately when braking hard. Severe or sharp steering wheel movement can still cause your vehicle to veer into oncoming traffic or off the road.

On loose or uneven road surfaces, operation of the anti-lock brake system may result in a longer stopping distance than for vehicles equipped with a conventional brake system.

The ABS warning light  will stay on for several seconds after the ignition switch is in the ON position. During that time, the ABS will go through self-diagnosis and the light will go off if everything is normal. If the light stays on, you may have a problem with your ABS. Contact an authorized HYUNDAI dealer as soon as possible.

### WARNING

If the ABS warning light  is on and stays on, you may have a problem with the ABS. Your power brakes will work normally. To reduce the risk of serious injury or death, contact your HYUNDAI dealer as soon as possible.

### CAUTION

When you drive on a road having poor traction, such as an icy road, and apply your brakes continuously, the ABS will be active continuously and the ABS warning light  may illuminate. Pull your car over to a safe place and turn the engine off.

Restart the engine. If the ABS warning light is off, then your ABS system is normal.

Otherwise, you may have a problem with your ABS system. Contact an authorized HYUNDAI dealer as soon as possible.

### Information

When you jump start your vehicle because of a drained battery, the ABS warning light  may turn on at the same time. This happens because of the low battery voltage. It does not mean your ABS is malfunctioning. Have the battery recharged before driving the vehicle.



## Electronic Stability Control (ESC) (if equipped)



The Electronic Stability Control (ESC) system helps to stabilize the vehicle during cornering maneuvers. ESC checks where you are steering and where the vehicle is actually going. ESC applies braking pressure to any one of the vehicle's brakes and intervenes in the engine management system to assist the driver with keeping the vehicle on the intended path. It is not a substitute for safe driving practices. Always adjust your speed and driving to the road conditions.



### **WARNING**

**Never drive too fast for the road conditions or too quickly when cornering. The ESC system will not prevent accidents.**

**Excessive speed in turns, abrupt maneuvers, and hydroplaning on wet surfaces can result in severe accidents.**

### **ESC operation**

#### **ESC ON condition**

When the ignition switch is in the ON position, the ESC and the ESC OFF indicator lights illuminate for approximately three seconds. After both lights go off, the ESC is enabled.

#### **When operating**



When the ESC is in operation, the ESC indicator light blinks:

- When you apply your brakes under conditions which may lock the wheels, you may hear sounds from the brakes, or feel a corresponding sensation in the brake pedal. This is normal and it means your ESC is active.
- When the ESC activates, the engine may not respond to the accelerator as it does under routine conditions.
- If the Cruise Control was in use when the ESC activates, the Cruise Control automatically disengages. The Cruise Control can be reengaged when the road conditions allow. See "Cruise Control System" later in this chapter. (if equipped)
- When moving out of the mud or driving on a slippery road, the engine RPM (revolutions per minute) may not increase even if you press the accelerator pedal deeply. This is to maintain the stability and traction of the vehicle and does not indicate a problem.

**ESC OFF condition**

To cancel ESC operation:

- **State 1**

Press the ESC OFF button briefly. The ESC OFF indicator light and message "Traction Control disabled" will illuminate. In this state, the traction control function of ESC (engine management) is disabled, but the brake control function of ESC (braking management) still operates.

- **State 2**

Press and hold the ESC OFF button continuously for more than 3 seconds. The ESC OFF indicator light and message "Traction and Stability Control disabled" illuminates and a warning chime sounds. In this state, both the traction control function of ESC (engine management) and the brake control function of ESC (braking management) are disabled.

If the ignition switch is placed to the LOCK/OFF position when ESC is off, ESC remains off. Upon restarting the engine, the ESC will automatically turn on again.

**Indicator lights**

- ESC indicator light (blinks)



- ESC OFF indicator light (comes on)



When the ignition switch is placed to the ON position, the ESC indicator light illuminates, then goes off if the ESC system is operating normally.

The ESC indicator light blinks whenever the ESC is operating.

If ESC indicator light stays on, your vehicle may have a malfunction with the ESC system. When this warning light illuminates have your vehicle checked by an authorized HYUNDAI dealer as soon as possible.

The ESC OFF indicator light comes on when the ESC is turned off.

 **WARNING**

When the ESC is blinking, this indicates the ESC is active:

**Drive slowly and NEVER attempt to accelerate. NEVER turn the ESC off while the ESC indicator light is blinking or you may lose control of the vehicle resulting in an accident.**

**NOTICE**

**Driving with wheels and tires with different sizes may cause the ESC system to malfunction. Before replacing tires, make sure all four tires and wheels are the same size. Never drive the vehicle with different sized wheels and tires installed.**

### **ESC OFF usage**

#### **When Driving**

The ESC OFF mode should only be used briefly to help free the vehicle if stuck in snow by temporarily stopping operation of the ESC to maintain wheel torque.

To turn ESC off while driving, press the ESC OFF button while driving on a flat road surface.

#### **NOTICE**

To prevent damage to the transmission:

- **Do not allow wheel(s) of one axle to spin excessively while the ESC, ABS, and parking brake warning lights are displayed. The repairs would not be covered by the vehicle warranty. Reduce engine power and do not spin the wheel(s) excessively while these lights are displayed.**
- **When operating the vehicle on a dynamometer, make sure the ESC is turned off (ESC OFF light illuminated).**

#### **i Information**

**Turning the ESC off does not affect ABS or standard brake system operation.**

### **Vehicle Stability Management (VSM) (if equipped)**

The Vehicle Stability Management (VSM) is a function of the Electronic Stability Control (ESC) system. It helps ensure the vehicle stays stable when accelerating or braking suddenly on wet, slippery and rough roads where traction over the four tires can suddenly become uneven.

#### **WARNING**

**Take the following precautions when using the Vehicle Stability Management (VSM):**

- **ALWAYS check the speed and the distance to the vehicle ahead. The VSM is not a substitute for safe driving practices.**
- **Never drive too fast for the road conditions. The VSM system will not prevent accidents. Excessive speed in bad weather, slippery and uneven roads can result in severe accidents.**

### **VSM operation**

#### **VSM ON condition**

The VSM operates when:

- The Electronic Stability Control (ESC) is on.
- Vehicle speed is approximately above 9 mph (15 km/h) on curve roads.
- Vehicle speed is approximately above 12 mph (20 km/h) when the vehicle is braking on rough roads.

#### **When operating**

When you apply your brakes under conditions which may activate the ESC, you may hear sounds from the brakes, or feel a corresponding sensation in the brake pedal. This is normal and it means your VSM is active.

#### **NOTICE**

**The VSM does not operate when:**

- **Driving on a banked road such as gradient or incline.**
- **Driving rearward.**
- **ESC OFF indicator light is on.**
- **EPS (Electric Power Steering) warning light () is on or blinks.**

**⚠ WARNING**

If ESC indicator light (🚗) or EPS warning light (⚡) stays on or blinks, your vehicle may have a malfunction with the VSM system. When the warning light illuminates, have your vehicle checked by an authorized HYUNDAI dealer as soon as possible.

Driving with wheels and tires with different sizes may cause the ESC system to malfunction. Before replacing tires, make sure all four tires and wheels are the same size. Never drive the vehicle with different sized tires and wheels installed.

**Hill-Start Assist Control (HAC) (if equipped)**

The Hill-Start Assist Control (HAC) helps prevent the vehicle from rolling backwards when starting a vehicle from a stop on a hill. The system operates the brakes automatically for approximately 2 seconds and releases the brake after 2 seconds or when the accelerator pedal is depressed.

**⚠ WARNING**

**Always be ready to depress the accelerator pedal when starting off on an incline. The HAC activates only for approximately 2 seconds.**

**NOTICE**

- **The HAC does not operate when the shift button is in P (Park) or N (Neutral)**
- **The HAC activates even though the ESC (Electronic Stability Control) is off but does not activate when the ESC has malfunctioned.**

**Good Braking Practices****⚠ WARNING**

**Whenever leaving the vehicle or parking, always come to a complete stop and continue to depress the brake pedal. Move the shift button into P (Park) position, then apply the parking brake, and place the ignition switch in the LOCK/OFF position.**

**Vehicles parked with the parking brake not applied or not fully engaged may roll inadvertently and may cause injury to the driver and others. ALWAYS apply the parking brake before exiting the vehicle.**

Wet brakes can be dangerous! The brakes may get wet if the vehicle is driven through standing water or if it is washed. Your vehicle will not stop as quickly if the brakes are wet. Wet brakes may cause the vehicle to pull to one side.

To dry the brakes, apply the brakes lightly until the braking action returns to normal, taking care to keep the vehicle under control at all times. If the braking action does not return to normal, stop as soon as it is safe to do so and call an authorized HYUNDAI dealer for assistance.

DO NOT drive with your foot resting on the brake pedal. Even light, but constant pedal pressure can result in the brakes overheating, brake wear, and possibly even brake failure.

If a tire goes flat while you are driving, apply the brakes gently and keep the vehicle pointed straight ahead while you slow down. When you are moving slowly enough for it to be safe to do so, pull off the road and stop in a safe location.

Keep your foot firmly on the brake pedal when the vehicle is stopped to prevent the vehicle from rolling forward.

## ISG (IDLE STOP AND GO) SYSTEM (IF EQUIPPED)

The Idle Stop and Go (ISG) system automatically and temporarily shuts down the engine when the vehicle is stopped and idling to help improve fuel efficiency and reduce exhaust gas emissions. (i.e. red stop light, stop sign, and traffic jam).

The engine is automatically started upon satisfying the starting conditions.

The ISG system is always active, when the engine is running.

### **i** Information

**When the engine is automatically started by the ISG system, some warning lights (i.e. ABS, ESC, ESC OFF, EPS, and parking brake warning light) may illuminate for a few seconds due to the low battery voltage. However, it does not indicate a malfunction with the ISG system.**

### To Activate the ISG System

#### **Prerequisite for activation**

The ISG system operates in the following situations.

- The driver's seatbelt is fastened
- The driver's door and hood are closed
- The brake vacuum pressure is adequate
- The battery sensor is activated and the battery is sufficiently charged
- Outside temperature is not too low or too high
- The vehicle is driven over a constant speed and stops
- The climate control system satisfies the conditions
- The vehicle is sufficiently warmed up
- The incline is gradual
- The steering wheel is turned less than 180 degrees and then the vehicle stops

### **i** Information

**If the ISG light (white) is turned on on the instrument cluster and does not meet the ISG system operating conditions, the ISG system is not activated.**

**When the ISG light (yellow) is on while the ISG system meets operating conditions, we recommend that the system be inspected by an authorized HYUNDAI dealer.**

#### **Auto stop**

To stop the engine in idle stop mode

1. Decrease the vehicle speed to 0 mph.
2. Depress the brake pedal with the shift button in D (Drive) or N (Neutral).

The auto stop indicator ((A)) illuminates in green on the instrument cluster, when the engine stops.

### **i** Information

**The driving speed must reach at least 3 mph (5 km/h) after an idle stop to stop the engine in idle stop mode again.**

In auto stop mode, when the driver opens the hood, the ISG system will be deactivated.

When the system is deactivated:



The ISG OFF button indicator illuminates. If the message "Auto Stop is Off."

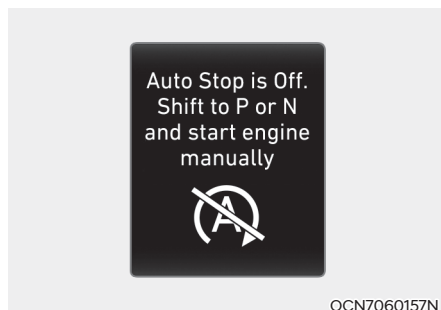

Shift to P or N and start engine manually, appears on the LCD display with a beep sound, restart the vehicle manually by depressing the brake pedal with the vehicle shifted to P (Park) or N (Neutral). For your safety, restart the vehicle in the P (Park) position.

### **Auto start**

To restart the engine in the auto stop mode

Release the brake pedal.

- When Auto Hold is activated, if you release the brake pedal, the engine will be in the auto stop state. However, if you depress the accelerator pedal, the engine will start again.

The auto stop indicator ((A)) goes to white on the instrument cluster, when the engine is restarted.

### **The engine is automatically restarted in the following situations.**

- The brake vacuum pressure is low
- The engine has stopped for about 5 minutes
- The air conditioning is ON with the fan speed set to the highest position
- The front defroster is ON
- The battery is weak
- The cooling and heating performance of the climate control system is unsatisfactory
- The vehicle is shifted to P (Park) when Auto Hold is activated
- The door is opened or the seatbelt is unfastened when Auto Hold is activated
- The EPB switch is pressed when Auto Hold is activated

The auto stop indicator ((A)) goes to white on the instrument cluster, when the engine is restarted.

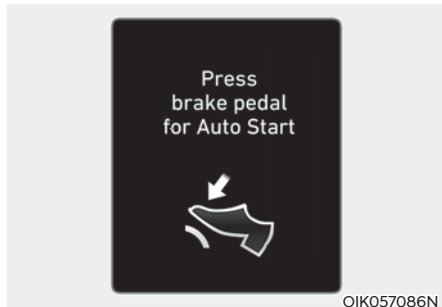

OIK057086N

The auto start is temporarily deactivated in the following situations.

When the gear is shifted from N (Neutral) to R (Reverse), D (Drive) or Manual shift mode without the brake pedal depressed. A message "Press brake pedal for Auto Start" will appear on the LCD display. To activate auto start, depress the brake pedal.

### To Deactivate the ISG System

- Press the ISG OFF button to deactivate the ISG system. Then, the ISG OFF button indicator illuminates.
- Press the ISG OFF button again to reactivate the ISG system. Then, the ISG OFF button indicator turns OFF.

### ISG System Malfunction

The ISG system may not operate:

When there is a malfunction with the ISG sensors or the ISG system.

The following occurs, when there is a malfunction with the ISG system:

- The auto stop indicator (Ⓐ) will illuminate in yellow on the instrument cluster.
- The light on the ISG OFF button will illuminate.

### Information

- When you cannot turn OFF the ISG OFF button indicator by pressing the ISG OFF button, or when the malfunction with the ISG system persists, contact an authorized HYUNDAI dealer.
- You can turn off the ISG OFF button indicator by driving over 50 mph (80 km/h) for up to 2 hours with the fan speed below the 2nd position. If the ISG OFF button indicator remains ON, contact an authorized HYUNDAI dealer.

### WARNING

When the engine is in auto stop mode, the engine may restart. Before leaving the vehicle or checking the engine compartment, stop the engine placing the ignition switch to the LOCK/OFF position or remove the ignition key.

## Battery Sensor Deactivation

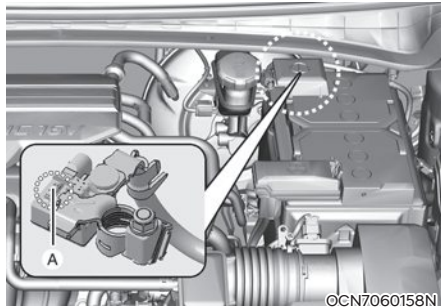

[A] : Battery sensor

The battery sensor is deactivated, when the battery is disconnected from the negative pole for maintenance purpose.

In this case, the ISG system is limitedly operated due to the battery sensor deactivation. Thus, the driver needs to take the following procedures to reactivate the battery sensor after disconnecting the battery.

### ***Prerequisites to reactivate the battery sensor***

Switch "ON" and "OFF" the ignition one time. Park the vehicle for a minimum of 4 hours with the hood and all doors closed.

Pay extreme caution not to connect any accessories (i.e. navigation and black box) to the vehicle with the engine in the OFF status. If not, the battery sensor may not be reactivated.

## **i** Information

The ISG system may not operate in the following situations.

- There is a malfunction with the ISG system.
- The battery is weak.
- The brake vacuum pressure is low.

If this occurs, have the ISG system checked by an authorized HYUNDAI dealer.

## **NOTICE**

- Use only a genuine HYUNDAI Absorbent Glass Mat (AGM) battery for replacement. If not, the ISG system may not operate normally.
- Do not recharge the Absorbent Glass Mat (AGM) battery with a general battery charger. It may damage or explode the Absorbent Glass Mat (AGM) battery.
- Do not remove the battery cap. The battery electrolyte, which is harmful to the human body, may leak out.



## DRIVE MODE INTEGRATED CONTROL SYSTEM (IF EQUIPPED)

### Drive Mode

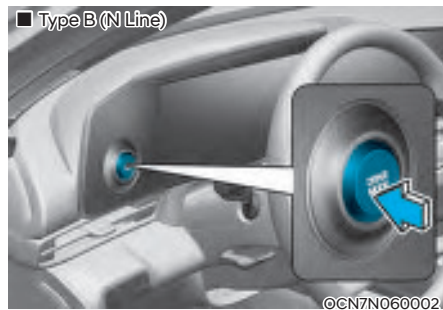
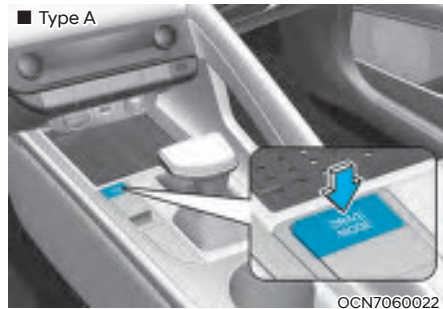

The drive mode may be selected according to the driver's preference or road condition.

### **i** Information

**If there is a problem with the instrument cluster, the drive mode will be in COMFORT mode and may not change to NORMAL mode or SPORT mode.**

The mode changes when you toggle the DRIVE MODE button.

COMFORT mode provides smooth driving and comfortable riding.

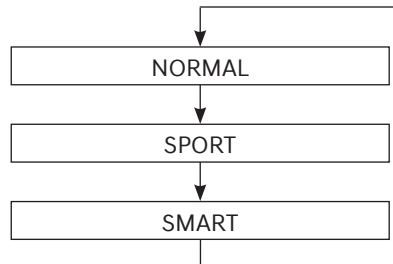

When NORMAL mode is selected, it is not displayed on the instrument cluster.

- **NORMAL mode :**  
NORMAL mode provides smooth driving and comfortable riding.
- **SPORT mode :**  
SPORT mode provides sporty but firm riding

The drive mode will change to NORMAL mode when the engine is restarted. However, except when it is in SMART mode. SMART mode will be maintained, as selected when the engine is restarted.

If you change the setting of the drive mode integrated control mode, SCC reaction of Smart Cruise Control is also changed. (if equipped)

Drive mode integrated control mode	SCC reaction
NORMAL	Normal
SPORT	Fast
SMART	Normal

**SPORT mode****SPORT**

SPORT mode manages the driving dynamics by automatically adjusting the steering effort, the engine and transmission control logic for enhanced driver performance.

- When SPORT mode is selected by using the DRIVE MODE button, the SPORT indicator will illuminate.
- Whenever the engine is restarted, the Drive Mode will revert back to NORMAL mode. If SPORT mode is desired, re-select SPORT mode from the DRIVE MODE button.
- When SPORT mode is activated:
  - The engine rpm will tend to remain raised over a certain length of time even after releasing the accelerator
  - Upshifts are delayed when accelerating

***i* Information**

In SPORT mode, the fuel efficiency may decrease.

**SMART mode****SMART**

SMART mode selects the proper driving mode among ECO, NORMAL, and SPORT by judging the driver's driving habits (i.e. Economic or Aggressive (Sportive) from the brake pedal depression or the steering wheel operation.

- Toggle the DRIVE MODE button to select SMART mode. When SMART mode is selected, the indicator illuminates on the instrument cluster.
- SMART mode automatically controls the vehicle driving, such as gear shifting patterns and engine torque, in accordance with the driver's driving habits.
- Whenever the engine is restarted, the drive mode remains in SMART mode.

***i* Information**

- **When you mildly drive the vehicle in SMART mode, the driving mode changes to SMART ECO mode to improve fuel efficiency. However, the actual fuel efficiency may differ in accordance with your driving situations (i.e. upward/downward slope, vehicle deceleration/acceleration).**
- **When you dynamically drive the vehicle in SMART mode by abruptly decelerating or sharply turning the driving mode changes to SMART SPORT mode. However, it may adversely affect fuel economy.**

### **Various driving situations, which you may encounter in SMART mode**

- The driving mode automatically changes to SMART ECO mode after a certain period of time, when you gently depress the accelerator pedal (Your driving is categorized to be economic.).
- The driving mode automatically changes from SMART ECO mode to SMART NORMAL mode after a certain period of time, when you sharply or repetitively depress the accelerator pedal.
- The driving mode automatically changes to SMART NORMAL mode with the same driving patterns, when the vehicle starts to drive on an upward slope of a certain angle. The driving mode automatically returns to SMART ECO mode, when the vehicle enters a leveled road.
- The driving mode automatically changes to SMART SPORT, when you abruptly accelerate the vehicle or repetitively operate the steering wheel (Your driving is categorized to be sporty.). In this mode, your vehicle drives in a lower gear for abrupt accelerating/decelerating and increases the engine brake performance.
- You may still sense the engine braking performance, even when you release the accelerator pedal in SMART SPORT mode. It is because your vehicle remains in lower gear over a certain period of time for next acceleration. Thus, it is a normal driving situation, not indicating any malfunction.
- The driving mode automatically changes to SMART SPORT mode only in harsh driving situations. In most of the normal driving situations, the driving mode sets to be either in SMART ECO mode or in SMART NORMAL mode.

### **Limitation of SMART mode**

The SMART mode may be limited in following situations. (The OFF indicator illuminates in those situations.)

- The cruise control is activated :  
The cruise control system may deactivate the SMART mode when the vehicle is controlled by the set speed of Smart Cruise Control system. (SMART mode is not deactivated just by activating the cruise control system.)
- The transmission oil temperature is either extremely low or extremely high :  
The SMART mode can be active in most of the normal driving situations. However, an extremely high/ low transmission oil temperature may temporarily deactivate the SMART mode, because the transmission condition is out of normal operation condition.

### Smart shift on trip computer (if equipped)

Select the Trip Computer mode  on the instrument cluster LCD display and move to the smart shift screen. Then, the driver can see the drive mode selected and the drive mode which is automatically switched by the SMART mode.



The drive mode selected by the driver (1) and the driving style gauge (2) showing the driver's driving style are displayed on the screen.

### Driver's style gauge in SMART mode

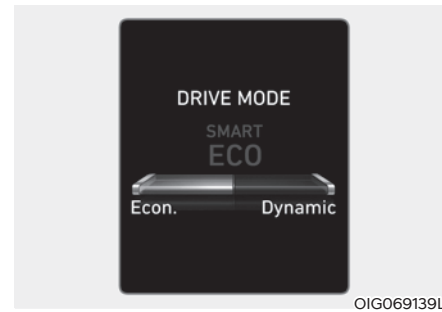
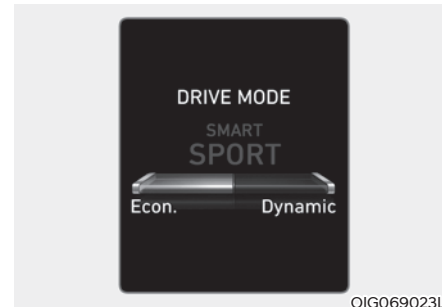

With the standard driving style in the center, the left side of the gauge is 'Econ.' and right side is 'Dynamic' style.

When the left side of the driver's style gauge is filled up and after a certain time passes, the SMART ECO mode is activated automatically. When the right side of the gauge is filled up and sporty driving condition is detected, the SMART SPORT mode is activated.

To maintain the SMART ECO mode for fuel efficiency, drive with the left side of the gauge filled up.

## SPECIAL DRIVING CONDITIONS

### Hazardous Driving Conditions

When hazardous driving elements are encountered such as water, snow, ice, mud and sand, take the below suggestions:

- Drive cautiously and keep a longer braking distance.
- Avoid abrupt braking or steering.
- When your vehicle is stuck in snow, mud, or sand, use second gear. Accelerate slowly to avoid unnecessary wheel spin.
- Put sand, rock salt, tire chains or other non-slip materials under the wheels to provide additional traction while the vehicle becomes stuck in ice, snow, or mud.



### WARNING

**Downshifting with an intelligent variable transmission while driving on slippery surfaces can cause an accident. The sudden change in tire speed could cause the tires to skid. Be careful when downshifting on slippery surfaces.**

### Rocking the Vehicle

If it is necessary to rock the vehicle to free it from snow, sand, or mud, first turn the steering wheel right and left to clear the area around your front wheels. Then, shift back and forth between R (Reverse) and a forward gear.

Try to avoid spinning the wheels, and do not race the engine.

To prevent transmission wear, wait until the wheels stop spinning before shifting gears. Release the accelerator pedal while shifting, and press lightly on the accelerator pedal while the transmission is in gear. Slowly spinning the wheels in forward and reverse directions causes a rocking motion that may free the vehicle.



### WARNING

**If the vehicle is stuck and excessive wheel spin occurs, the temperature of the tires can increase very quickly. If the tires become damaged, a tire blow out or tire explosion can occur. This condition is dangerous - you and others may be injured. Do not attempt this procedure if people or objects are anywhere near the vehicle.**

**If you attempt to free the vehicle, the vehicle can overheat quickly, possibly causing an engine compartment fire or other damage. Try to avoid spinning the wheels as much as possible to prevent overheating of either the tires or the engine. DO NOT allow the vehicle to spin the wheels above 35 mph (56 km/h).**



### Information

The ESC system must be turned OFF before rocking the vehicle.

### NOTICE

**If you are still stuck after rocking the vehicle a few times, have the vehicle pulled out by a tow vehicle to avoid engine overheating, possible damage to the transmission, and tire damage. See "Towing" in chapter 7.**

### Smooth Cornering

Avoid braking or gear changing in corners, especially when roads are wet. Ideally, corners should always be taken under gentle acceleration.

### Driving at Night

Night driving presents more hazards than driving in the daylight. Here are some important tips to remember:

- Slow down and keep more distance between you and other vehicles, as it may be more difficult to see at night, especially in areas where there may not be any street lights.
- Adjust your mirrors to reduce the glare from other driver's headlamps.
- Keep your headlamps clean and properly aimed. Dirty or improperly aimed headlamps will make it much more difficult to see at night.
- Avoid staring directly at the headlamps of oncoming vehicles. You could be temporarily blinded, and it will take several seconds for your eyes to readjust to the darkness.

### Driving in the Rain

Rain and wet roads can make driving dangerous. Here are a few things to consider when driving in the rain or on slick pavement:

- Slow down and allow extra following distance. A heavy rainfall makes it harder to see and increases the distance needed to stop your vehicle.
- Turn OFF your Cruise Control.
- Replace your windshield wiper blades when they show signs of streaking or missing areas on the windshield.
- Tires should be properly maintained with at least 2/32nds of an inch of tread depth. If your tires do not have enough tread, making a quick stop on wet pavement can cause a skid and possibly lead to an accident. **See "Tire Tread" in chapter 8.**
- Turn on your headlamps to make it easier for others to see you.
- Driving too fast through large puddles can affect your brakes. If you must go through puddles, try to drive through them slowly.
- If you believe your brakes may be wet, apply them lightly while driving until normal braking operation returns.

### Hydroplaning

If the road is wet enough and you are going fast enough, your vehicle may have little or no contact with the road surface and actually ride on the water. The best advice is SLOW DOWN when the road is wet.

**The risk of hydroplaning increases as the depth of tire tread decreases, refer to "Tire Tread" in chapter 8.**

### Driving in Flooded Areas

Avoid driving through flooded areas unless you are sure the water is no higher than the bottom of the wheel hub. Drive through any water slowly. Allow adequate stopping distance because brake performance may be reduced.

After driving through water, dry the brakes by gently applying them several times while the vehicle is moving slowly.

### Highway Driving

#### **Tires**

Adjust the tire inflation, as specified. Under-inflation may overheat or damage the tires.

Do not install worn-out or damaged tires, which may reduce traction or adversely affect vehicle handling. This could lead to sudden tire failure that may cause loss of vehicle control resulting in an accident.

### Information

**Never over-inflate your tires above the maximum inflation pressure, as specified on your tires.**

#### ***Fuel, engine coolant and engine oil***

Driving at higher speeds on the highway consumes more fuel and is less efficient than driving at a slower, more moderate speed. Maintain a moderate speed in order to conserve fuel when driving on the highway.

Be sure to check both the engine coolant level and the engine oil before driving.

#### ***Drive belt***

A loose or damaged drive belt may overheat the engine.

## WINTER DRIVING

The severe weather conditions of winter quickly wear out tires and cause other problems. To minimize winter driving problems, you should take the following suggestions:

### Snow or Icy Conditions

You need to keep sufficient distance between your vehicle and the vehicle in front of you.

Apply the brakes gently. Speeding, rapid acceleration, sudden brake applications, and sharp turns are potentially very hazardous practices. During deceleration, use engine braking to the fullest extent. Sudden brake applications on snowy or icy roads may cause the vehicle to skid.

To drive your vehicle in deep snow, it may be necessary to use snow tires or to install tire chains on your tires.

Always carry emergency equipment. Some of the items you may want to carry include tire chains, tow straps or chains, a flashlight, emergency flares, sand, a shovel, jumper cables, a window scraper, gloves, ground cloth, coveralls, a blanket, etc.

### Snow tires



**Snow tires should be equivalent in size and type to the vehicle's standard tires. Otherwise, the safety and handling of your vehicle may be adversely affected.**

If you mount snow tires on your vehicle, make sure to use radial tires of the same size and load range as the original tires. Mount snow tires on all four wheels to balance your vehicle's handling in all weather conditions. The traction provided by snow tires on dry roads may not be as high as your vehicle's original equipment tires. Check with the tire dealer for maximum speed recommendations.



**Do not install studded tires without first checking local, state and municipal regulations for possible restrictions against their use.**

### Tire chains

Since the sidewalls of radial tires are thinner than other types of tires, they may be damaged by mounting some types of tire chains on them. Therefore the use of snow tires is preferred over the use of tire chains.

If the road and weather conditions require the use of tire chains, be sure to use tire chains that have been properly selected for the size of tire on your HYUNDAI vehicle.

Be sure to follow the guidelines and installation instructions provided from the tire chain manufacturer.

Damage to your vehicle caused by improper tire chain use is not covered by your vehicle manufacturer's warranty.





### WARNING

The use of tire chains may adversely affect vehicle handling:

- Drive less than 20 mph (30 km/h) or the chain manufacturer's recommended speed limit, whichever is lower.
- Drive carefully and avoid bumps, holes, sharp turns, and other road hazards, which may cause the vehicle to bounce.
- Avoid sharp turns or locked wheel braking.



### CAUTION

If your vehicle has 235/40R18 size tires, do not use tire chain; they can damage your vehicle (wheel, suspension and body).



### Information

- Install tire chains on both left and right front tires. It should be noted that installing tire chains on the tires will provide a greater driving force, but will not prevent side skids.
- Do not install studded tires without first checking local, state and municipal regulations for possible restrictions against their use.

### Chain installation

When installing tire chains, follow the manufacturer's instructions and mount them as tightly possible. Drive slowly (less than 20 mph (30 km/h)) with chains installed. If you hear the chains contacting the body or chassis, stop and tighten them. If they still make contact, slow down until the noise stops. Remove the tire chains as soon as you begin driving on cleared roads.

When mounting snow chains, park the vehicle on level ground away from traffic. Turn on the vehicle Hazard Warning Flasher and place a triangular emergency warning device behind the vehicle (if available). Always place the vehicle in P (Park), apply the parking brake and turn off the engine before installing snow chains.

### NOTICE

When using tire chains:

- Wrong size chains or improperly installed chains can damage your vehicle's brake lines, suspension, body and wheels.
- Use SAE "S" class or wire chains.
- If you hear noise caused by chains contacting the body, retighten the chain to prevent contact with the vehicle body.
- To prevent body damage, retighten the chains after driving 0.3–0.6 miles (0.5–1.0 km).
- Do not use tire chains on vehicles equipped with aluminum wheels. If unavoidable, use a wire type chain.
- Use wire chains less than 0.59 inch (15mm) wide to prevent damage to the chain's connection.

## Winter Precautions

### **Use high quality ethylene glycol coolant**

Your vehicle is delivered with high quality ethylene glycol coolant in the cooling system. It is the only type of coolant that should be used because it helps prevent corrosion in the cooling system, lubricates the water pump and prevents freezing. Be sure to replace or replenish your coolant in accordance with the maintenance schedule in chapter 8. Before winter, have your coolant tested to assure that its freezing point is sufficient for the temperatures anticipated during the winter.

### **Change to "winter weight" oil if necessary**

In some climates it is recommended that a lower viscosity "winter weight" oil be used during cold weather. See chapter 8 for recommendations. If you aren't sure what weight oil you should use, consult an authorized HYUNDAI dealer.

### **Check battery and cables**

Winter puts additional burdens on the battery system. Visually inspect the battery and cables as described in chapter 8. The level of charge in your battery can be checked by an authorized HYUNDAI dealer or a service station.

### **Check spark plugs and ignition system**

Inspect your spark plugs as described in chapter 8 and replace them if necessary. Also check all ignition wiring and components to be sure they are not cracked, worn or damaged in any way.

### **Use approved window washer anti-freeze in system**

To keep the water in the window washer system from freezing, add an approved window washer anti-freeze solution in accordance with instructions on the container.

Window washer anti-freeze is available from an authorized HYUNDAI dealer and most auto parts outlets. Do not use engine coolant or other types of antifreeze as these may damage the paint finish.

### **Do not let your parking brake freeze**

Under some conditions your parking brake can freeze in the engaged position. This is most likely to happen when there is an accumulation of snow or ice around or near the rear brakes or if the brakes are wet. If there is a risk the parking brake may freeze, apply it only temporarily while you put the gear selector lever in P and block the rear wheels so the car cannot roll. Then release the parking brake.

### **Do not let ice and snow accumulate underneath**

Under some conditions, snow and ice can build up under the fenders and interfere with the steering. When driving in severe winter conditions where this may happen, you should periodically check underneath the car to be sure the movement of the front wheels and the steering components is not obstructed.

### **Don't place foreign objects or materials in the engine compartment**

Placement of foreign object or materials which prevent cooling of the engine, in the engine compartment, may cause a failure or combustion. The manufacturer is not responsible for the damage caused by such placement.

### **To keep locks from freezing**

To keep the locks from freezing, squirt an approved de-icer fluid or glycerine into the key opening. If a lock is covered with ice, squirt it with an approved de-icing fluid to remove the ice. If the lock is frozen internally, you may be able to thaw it out by using a heated key. Handle the heated key with care to avoid injury.

## VEHICLE LOAD LIMIT

Two labels on your driver's door sill show how much weight your vehicle was designed to carry: the Tire and Loading Information Label and the Certification Label.

Before loading your vehicle, familiarize yourself with the following terms for determining your vehicle's weight ratings, from the vehicle's specifications and the Certification Label:

### Base Curb Weight

This is the weight of the vehicle including a full tank of fuel and all standard equipment. It does not include passengers, cargo, or optional equipment.

### Vehicle Curb Weight

This is the weight of your new vehicle when you picked it up from your dealer plus any aftermarket equipment.

### Cargo Weight

This figure includes all weight added to the Base Curb Weight, including cargo and optional equipment.

### GAW (Gross Axle Weight)

This is the total weight placed on each axle (front and rear) - including vehicle curb weight and all payload.

### GAWR (Gross Axle Weight Rating)

This is the maximum allowable weight that can be carried by a single axle (front or rear). These numbers are shown on the Certification Label. The total load on each axle must never exceed its GAWR.

### GVW (Gross Vehicle Weight)

This is the Base Curb Weight plus actual Cargo Weight plus passengers.

### GVWR (Gross Vehicle Weight Rating)

This is the maximum allowable weight of the fully loaded vehicle (including all options, equipment, passengers and cargo). The GVWR is shown on the Certification Label located on the driver's door sill.

## Tire Loading Information Label

### ■ Type A

TYRE AND LOADING INFORMATION RENSEIGNEMENTS SUR LES PNEUS ET LE CHARGEMENT			
SEATING CAPACITY NOMBRE DE PLACES		TOTAL 5	FRONT 2 ARRIÈRE 3
The combined weight of occupants and cargo should never exceed 865 kg or 849 lbs. Le poids total des occupants et du chargement ne doit jamais dépasser 865 kg ou 849 lbs.			
TYRE PNEU	SIZE DIMENSIONS	COLD TYRE PRESSURE PRESSION DES PNEUS À FROID	SEE OWNER'S MANUAL FOR ADDITIONAL INFORMATION VOIR LE MANUEL DE L'USAGER POUR PLUS DE RENSEIGNEMENTS
FRONT AVANT	195/65R15	235kPa, 34psi	
REAR ARRIÈRE	195/65R15	215kPa, 31psi	
SPARE DE SECOURS	T125/80D15	420kPa, 60psi	

OCN7060160N

### ■ Type B

TYRE AND LOADING INFORMATION RENSEIGNEMENTS SUR LES PNEUS ET LE CHARGEMENT			
SEATING CAPACITY NOMBRE DE PLACES		TOTAL 5	FRONT 2 ARRIÈRE 3
The combined weight of occupants and cargo should never exceed 865 kg or 849 lbs. Le poids total des occupants et du chargement ne doit jamais dépasser 865 kg ou 849 lbs.			
TYRE PNEU	SIZE DIMENSIONS	COLD TYRE PRESSURE PRESSION DES PNEUS À FROID	SEE OWNER'S MANUAL FOR ADDITIONAL INFORMATION VOIR LE MANUEL DE L'USAGER POUR PLUS DE RENSEIGNEMENTS
FRONT AVANT	205/55R16	235kPa, 34psi	
REAR ARRIÈRE	205/55R16	215kPa, 31psi	
SPARE DE SECOURS	T125/80D15	420kPa, 60psi	

OCN7060161N

### ■ Type C

TYRE AND LOADING INFORMATION RENSEIGNEMENTS SUR LES PNEUS ET LE CHARGEMENT			
SEATING CAPACITY NOMBRE DE PLACES		TOTAL 5	FRONT 2 ARRIÈRE 3
The combined weight of occupants and cargo should never exceed 865 kg or 849 lbs. Le poids total des occupants et du chargement ne doit jamais dépasser 865 kg ou 849 lbs.			
TYRE PNEU	SIZE DIMENSIONS	COLD TYRE PRESSURE PRESSION DES PNEUS À FROID	SEE OWNER'S MANUAL FOR ADDITIONAL INFORMATION VOIR LE MANUEL DE L'USAGER POUR PLUS DE RENSEIGNEMENTS
FRONT AVANT	225/45R17	230kPa, 34psi	
REAR ARRIÈRE	225/45R17	215kPa, 31psi	
SPARE DE SECOURS	T125/80D15	420kPa, 60psi	

OCN7060162N

### ■ Type D

TYRE AND LOADING INFORMATION RENSEIGNEMENTS SUR LES PNEUS ET LE CHARGEMENT			
SEATING CAPACITY NOMBRE DE PLACES		TOTAL 5	FRONT 2 ARRIÈRE 3
The combined weight of occupants and cargo should never exceed 865 kg or 849 lbs. Le poids total des occupants et du chargement ne doit jamais dépasser 865 kg ou 849 lbs.			
TYRE PNEU	SIZE DIMENSIONS	COLD TYRE PRESSURE PRESSION DES PNEUS À FROID	SEE OWNER'S MANUAL FOR ADDITIONAL INFORMATION VOIR LE MANUEL DE L'USAGER POUR PLUS DE RENSEIGNEMENTS
FRONT AVANT	235/40R18	230kPa, 33psi	
REAR ARRIÈRE	235/40R18	230kPa, 33psi	
SPARE DE SECOURS	T125/80D16	420kPa, 60psi	

OCN7060163N

The label located on the driver's door sill gives the original tire size, cold tire pressures recommended for your vehicle, the number of people that can be in your vehicle and vehicle capacity weight.

### **Vehicle capacity weight** **849 lbs. (385 kg)**

Vehicle capacity weight is the maximum combined weight of occupants and cargo. If your vehicle is equipped with a trailer, the combined weight includes the tongue load.

### **Seating capacity**

Total: 5 persons  
(Front seat : 2 persons,  
Rear seat : 3 persons)

Seating capacity is the maximum number of occupants including a driver, your vehicle may carry. However, the seating capacity may be reduced based upon the weight of all of the occupants, and the weight of the cargo being carried or towed. Do not overload the vehicle as there is a limit to the total weight, or load limit including occupants and cargo, the vehicle can carry.

### **Towing capacity**

We do not recommend using this vehicle for trailer towing.

### **Cargo capacity**

The cargo capacity of your vehicle will increase or decrease depending on the weight and the number of occupants and the tongue load, if your vehicle is equipped with a trailer.







**Steps for determining correct load limit**

1. Locate the statement "The combined weight of occupants and cargo should never exceed XXX kg or XXX lbs." on your vehicle's placard.
2. Determine the combined weight of the driver and passengers that will be riding in your vehicle.
3. Subtract the combined weight of the driver and passengers from XXX kg or XXX lbs.
4. The resulting figure equals the available amount of cargo and luggage load capacity. For example, if the "XXX" amount equals 1400 lbs. and there will be five 150 lb. passengers in your vehicle, the amount of available cargo and luggage load capacity is 650 lbs. (1400 - 750 (5 x 150) = 650 lbs.)
5. Determine the combined weight of luggage and cargo being loaded on the vehicle. That weight may not safely exceed the available cargo and luggage load capacity calculated in Step 4.
6. If your vehicle will be towing a trailer, load from your trailer will be transferred to your vehicle. Consult this manual to determine how this reduces the available cargo and luggage load capacity of your vehicle.



**WARNING**

**Do not overload the vehicle as there is a limit to the total weight, or load limit, including occupants and cargo, the vehicle can carry. Overloading can shorten the life of the vehicle. If the GVWR or the GAWR is exceeded, parts on the vehicle can break, and it can change the handling of your vehicle. These could cause you to lose control and result in an accident.**

<p><b>Example 1</b></p>	<p><b>Vehicle Capacity</b></p> <p>Maximum Load (1400 lbs.) (635 kg)</p>	$\geq$	 <p>Passenger Weight (150 lbs. <math>\times</math> 2 = 300 lbs.) (68 kg <math>\times</math> 2 = 136 kg)</p>	<p>+</p>	 <p>Cargo Weight (1100 lbs.) (499 kg)</p>
<p><b>Example 2</b></p>	<p><b>Vehicle Capacity</b></p> <p>Maximum Load (1400 lbs.) (635 kg)</p>	$\geq$	 <p>Passenger Weight (150 lbs. <math>\times</math> 5 = 750 lbs.) (68 kg <math>\times</math> 5 = 340 kg)</p>	<p>+</p>	 <p>Cargo Weight (650 lbs.) (295 kg)</p>
<p><b>Example 3</b></p>	<p><b>Vehicle Capacity</b></p> <p>Maximum Load (1400 lbs.) (635 kg)</p>	$\geq$	 <p>Passenger Weight (172 lbs. <math>\times</math> 5 = 860 lbs.) (78 kg <math>\times</math> 5 = 390 kg)</p>	<p>+</p>	 <p>Cargo Weight (540 lbs.) (245 kg)</p>

### Certification label



The certification label is located on the driver's door sill at the center pillar and shows the maximum allowable weight of the fully loaded vehicle. This is called the GVWR (Gross Vehicle Weight Rating). The GVWR includes the weight of the vehicle, all occupants, fuel and cargo.

This label also tells you the maximum weight that can be supported by the front and rear axles, called Gross Axle Weight Rating (GAWR).

The total weight of the vehicle, including all occupants, accessories, cargo, and trailer tongue load must not exceed the Gross Vehicle Weight Rating (GVWR) or the Gross Axle Weight Rating (GAWR). To find out the actual loads on your front and rear axles, you need to go to a weigh station and weigh your vehicle. Be sure to spread out your load equally on both sides of the centerline.

### WARNING

#### Overloading

- Never exceed the GVWR for your vehicle, the GAWR for either the front or rear axle and vehicle capacity weight. Exceeding these ratings can affect your vehicle's handling and braking ability, and cause an accident.
- Do not overload your vehicle. Overloading your vehicle can cause heat buildup in your vehicle's tires and possible tire failure, increased stopping distances and poor vehicle handling—all of which may result in a crash.

### **NOTICE**

Overloading your vehicle may cause damage. Repairs would not be covered by your warranty. Do not overload your vehicle.

### WARNING

If you carry items inside your vehicle (e.g., suitcases, tools, packages, or anything else), they are moving as fast as the vehicle. If you have to stop or turn quickly, or if there is a crash, the items will keep going and can cause an injury if they strike the driver or a passenger.

- Put items in the cargo area of your vehicle. Try to spread the weight evenly.
- Do not stack items, like suitcases, inside the vehicle above the tops of the seats.
- Do not leave an unsecured child restraint in your vehicle.
- When you carry something inside the vehicle, secure it.

---

**TRAILER TOWING**

We do not recommend using this vehicle for trailer towing.



# 7. Driver assistance system

---

Driving Safety	
Forward Collision-Avoidance Assist (FCA) (front view camera only) .....	7-2
Forward Collision-Avoidance Assist (FCA) (sensor fusion) .....	7-14
Lane Keeping Assist (LKA) .....	7-30
Blind-Spot Collision Warning (BCW) .....	7-37
Blind-Spot Collision-Avoidance Assist (BCA) .....	7-46
Safe Exit Warning (SEW) .....	7-60
Manual Speed Limit Assist (MSLA) .....	7-65
Driver Attention Warning (DAW).....	7-68
Driving Convenience	
Cruise Control (CC) .....	7-74
Smart Cruise Control (SCC) .....	7-78
Navigation-Based Smart Cruise Control (NSCC) .....	7-95
Lane Following Assist (LFA) .....	7-102
Highway Driving Assist (HDA) .....	7-106
Parking Safety	
Rear View Monitor (RVM).....	7-113
Rear Cross-Traffic Collision Warning (RCCW) .....	7-117
Rear Cross-Traffic Collision-Avoidance Assist (RCCA) .....	7-125
Reverse Parking Distance Warning (PDW) .....	7-135
Reverse Parking Collision-Avoidance Assist (PCA) .....	7-138
Declaration of conformity .....	7-146

## FORWARD COLLISION-AVOIDANCE ASSIST (FCA) (FRONT VIEW CAMERA ONLY) (IF EQUIPPED)

### Basic function

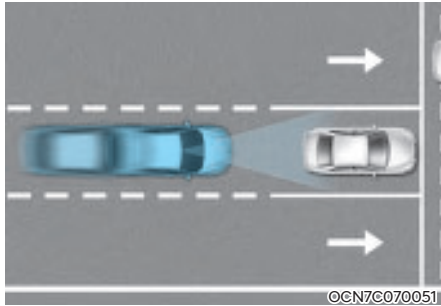

Forward Collision-Avoidance Assist is designed to help detect and monitor the vehicle ahead or detect a pedestrian in the roadway and warn the driver that a collision is imminent with a warning message and audible warning, and if necessary, apply emergency braking.

### Detecting sensor



[1] : Front view camera

Refer to the picture above for the detailed location of the detecting sensor.



### CAUTION

Take the following precautions to maintain optimal performance of the detecting sensor:

- **NEVER** disassemble the detecting sensor or sensor assembly, or apply any impact on it.
- If the detecting sensors have been replaced or repaired, we recommend that you have your vehicle inspected by an authorized HYUNDAI dealer.
- **NEVER** install any accessories or stickers on the front windshield, or tint the front windshield.
- **Pay extreme caution** to keep the front view camera dry.
- **NEVER** place any reflective objects (i.e. white paper, mirror) over the dashboard. Any light reflection may prevent the system from functioning properly.

## Function settings

### Setting

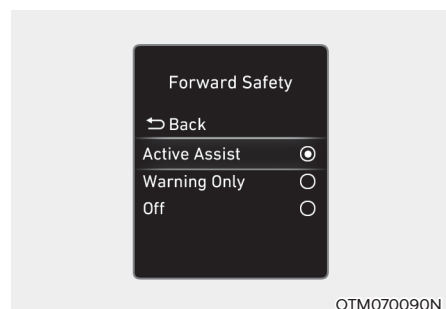

#### Forward Safety

With the engine on, select 'Driver Assistance → Forward Safety' from the Settings menu to set whether or not to use each function.

- If 'Active Assist' is selected, the function will warn the driver with a warning message and an audible warning depending on the collision risk levels. Braking assist will be applied depending on the collision risk.
- If 'Warning Only' is selected, the function will warn the driver with a warning message and an audible warning depending on the collision risk levels. Braking will not be assisted.
- If 'Off' is selected, the system will turn off. The  warning light will illuminate on the cluster.

The driver can monitor Forward Collision-Avoidance Assist ON/OFF status from the Settings menu. If the  warning light remains ON when the system is ON, we recommend that you have the function inspected by an authorized HYUNDAI dealer.

### WARNING

When the engine is restarted, Forward Collision-Avoidance Assist will always turn on. However, if 'Off' is selected after the engine is restarted, the driver should always be aware of the surroundings and drive safely.

### CAUTION

'If 'Warning Only' is selected, braking is not assisted.

### Information

Forward Collision-Avoidance Assist will turn off when ESC is turned off by pressing and holding the ESC OFF button for more than 3 seconds. The  warning light will illuminate on the cluster.



### Warning Timing

With the engine on, select 'Driver Assistance → Warning Timing' from the Settings menu to change the initial warning activation time for Forward Collision-Avoidance Assist.

When the vehicle is first delivered, Warning Timing is set to 'Normal'. If you change the Warning Timing, the warning time of other Driver Assistance systems may change.

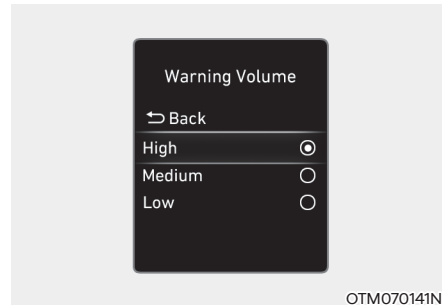

### Warning Volume

With the engine on, select 'Driver Assistance → Warning Volume' from the Settings menu to change the Warning Volume to 'High', 'Medium' or 'Low' for Forward Collision-Avoidance Assist.

If you change the warning volume, the Warning Volume of other Driver Assistance systems may change.



### CAUTION

- Even though, 'Normal' is selected for Warning Timing if the front vehicle suddenly stops the initial warning activation time may seem late.
- Select 'Late' for Warning Timing when traffic is light and when driving speed is slow.



### Information

If the engine is restarted, Warning Timing and Warning Volume will maintain the last setting.

## Function operation

### Basic function

#### Function warning and control

The basic feature of Forward Collision-Avoidance Assist is to help warn and control the vehicle depending on collision risk level : 'Collision Warning', 'Emergency Braking' and 'Stopping vehicle and ending brake control'.

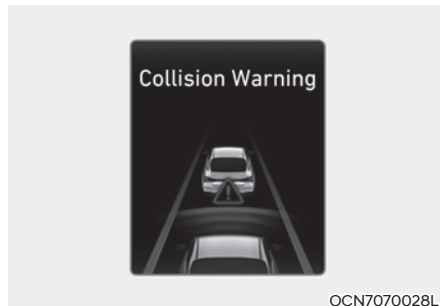

#### Collision warning

- To warn the driver of a collision, the 'Collision Warning' warning message will appear on the cluster and an audible warning will sound.
- If a vehicle is detected in front, the function will operate when your vehicle speed is between approximately 6~112 mph (10~180 km/h).
- If a pedestrian is detected in front, the function will operate when your vehicle speed is between approximately 6~53 mph (10~85 km/h).
- If 'Active Assist' is selected, braking may be assisted.

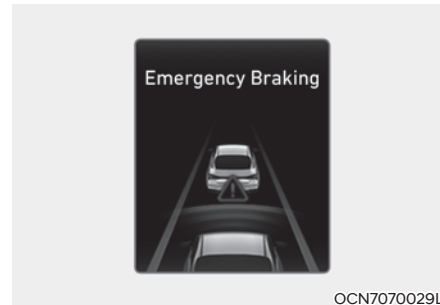

#### Emergency braking

- To warn the driver that emergency braking will occur, the 'Emergency Braking' warning message will appear on the cluster and an audible warning will sound.
- If a vehicle is detected in front, the function will operate when your vehicle speed is between approximately 6~47 mph (10~75 km/h).
- If a pedestrian is detected in front, the function will operate when your vehicle speed is between approximately 6~47 mph (10~75 km/h).
- In emergency braking situation, braking is assisted with strong braking power by the function to help prevent collision with the vehicle or pedestrian ahead.



**Stopping vehicle and ending brake control**

- When the vehicle is stopped due to emergency braking, 'Drive carefully' warning message will appear on the cluster.  
For your safety, the driver should depress the brake pedal immediately and check the surroundings.
- Brake control will end after the vehicle is stopped by emergency braking for approximately 2 seconds.

 **WARNING**

Take the following precautions when using Forward Collision-Avoidance Assist:

- For your safety, change the Settings after parking the vehicle at a safe location.
  - With 'Active Assist' or 'Warning Only' selected, when ESC is turned off by pressing and holding the ESC OFF button for more than 3 seconds, Forward Collision-Avoidance Assist will turn off automatically. In this case, the function cannot be set from the Settings menu and the  warning light will illuminate on the cluster which is normal. If ESC is turned on by pressing the ESC OFF button, Forward Collision-Avoidance Assist will maintain the last setting.
- Forward Collision-Avoidance Assist does not operate in all situations or cannot avoid all collisions.
  - The driver should hold the responsibility to control the vehicle. Do not solely depend on Forward Collision-Avoidance Assist. Rather, maintain a safe braking distance, and, if necessary, depress the brake pedal to reduce driving speed or to stop the vehicle.
  - Never deliberately operate Forward Collision-Avoidance Assist on people, animal, objects, etc. It may cause serious injury or death.
  - Forward Collision-Avoidance Assist may not operate if the driver depresses the brake pedal to avoid collision.
  - Depending on the road and driving conditions, Forward Collision-Avoidance Assist may warn the driver late or may not warn the driver.
  - During Forward Collision-Avoidance Assist operation the vehicle may stop suddenly injuring passengers and shifting loose objects. Always have the seat belt on and keep loose objects secured.
  - If any other system's warning message is displayed or audible warning is generated, Forward Collision-Avoidance Assist warning message may not be displayed and audible warning may not be generated.
  - You may not hear the warning sound of Forward Collision-Avoidance Assist if the surrounding is noisy.
  - Forward Collision-Avoidance Assist may turn off or may not operate properly or may operate unnecessarily depending on the road conditions and the surroundings.

**⚠ WARNING**

- Even if there is a problem with Forward Collision-Avoidance Assist, the vehicle's basic braking performance will operate normally.
- During emergency braking, braking control by the function will automatically cancel when the driver excessively depresses the accelerator pedal or sharply steers the vehicle.



**⚠ CAUTION**

Forward Collision-Avoidance Assist operating speed range may reduce due to the conditions of the vehicle or pedestrian in front or surroundings. Depending on the speed, the function may only warn the driver, or the function may not operate.

***i* Information**

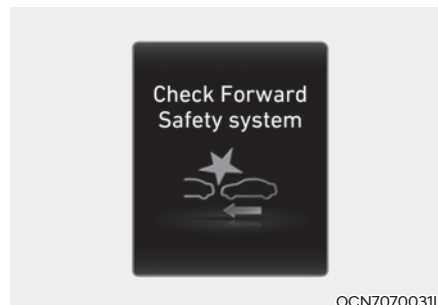
In a situation where collision is imminent, braking may be assisted by Forward Collision-Avoidance Assist when braking is insufficient by the driver.



**Function malfunction and limitations*****Function malfunction***

When Forward Collision-Avoidance Assist system is not working properly, the 'Check Forward Safety system(s)' warning message will appear, and the  and  warning lights will illuminate on the cluster. We recommend that the function be inspected by an authorized HYUNDAI dealer.

### Function disabled



When the front windshield where the front view camera is located or the sensor is covered with foreign material, such as snow or rain, it can reduce the detecting performance and temporarily limit or disable Forward Collision-Avoidance Assist.

If this occurs the 'Forward Safety system disabled. Camera obscured' warning message, and the  and  warning lights will illuminate on the cluster.

The system will operate normally when such snow, rain or foreign material is removed.

If the system does not operate normally after obstruction (snow, rain, or foreign material) is removed, we recommend that the system be inspected by an authorized HYUNDAI dealer.

### WARNING

- **Even though the warning message or warning light does not appear on the cluster, Forward Collision-Avoidance Assist may not properly operate.**
- **Forward Collision-Avoidance Assist may not properly operate in an area (e.g. open terrain), where any objects are not detected after turning ON the engine.**

### Limitations of the function

Forward Collision-Avoidance Assist may not operate normally, OR the function may operate unexpectedly under the following circumstances:

- The detecting sensor or the surroundings are contaminated or damaged
- The temperature around the front view camera is high or low
- The camera lens is contaminated due to tinted, filmed or coated windshield, damaged glass, or foreign material (sticker, bug, etc.) on the glass
- Moisture is not removed or frozen on the windshield
- Washer fluid is continuously sprayed, or the wiper is on
- Driving in heavy rain or snow, or thick fog
- The field of view of the front view camera is obstructed by sun glare
- Street light or light from an oncoming vehicle is reflected on the wet road surface, such as a puddle on the road
- An object is placed on the dashboard
- Your vehicle is being towed
- The surrounding is very bright
- The surrounding is very dark, such as in a tunnel, etc.
- The brightness changes suddenly, for example when entering or exiting a tunnel
- The brightness outside is low, and the headlamps are not on or are not bright



- Driving through steam, smoke or shadow
- Only part of the vehicle, pedestrian or cyclist is detected
- The vehicle in front is a bus, heavy truck, truck with a unusually shaped luggage, trailer, etc.
- The vehicle in front has no tail lights, tail lights are located unusually, etc.
- The brightness outside is low, and the tail lamps are not on or are not bright
- The rear of the front vehicle is small or the vehicle does not look normal, such as when the vehicle is tilted, overturned, or the side of the vehicle is visible, etc.
- The front vehicle's ground clearance is low or high
- A vehicle or pedestrian suddenly cuts in front
- The vehicle in front is detected late
- The vehicle in front is suddenly blocked by an obstacle
- The vehicle in front suddenly changes lane or suddenly reduces speed
- The vehicle in front is bent out of shape
- The front vehicle's speed is fast or slow
- The vehicle in front steers in the opposite direction of your vehicle to avoid a collision
- With a vehicle in front, your vehicle changes lane at low speed
- The vehicle in front is covered with snow
- You are departing or returning to the lane
- Unstable driving
- You are on a roundabout and the vehicle in front is not detected
- You are continuously driving in a circle
- The vehicle in front has an unusual shape
- The vehicle in front is driving uphill or downhill
- The pedestrian is not fully detected, for example, if the pedestrian is leaning over or is not fully walking upright
- The pedestrian is wearing clothing or equipment that makes it difficult to detect as a pedestrian



The illustration above shows the image the front view camera will detect as a vehicle and pedestrian.

- The pedestrian in front is moving very quickly
- The pedestrian in front is short or is posing a low posture
- The pedestrian in front has impaired mobility
- The pedestrian in front is moving intersected with the driving direction

- There is a group of pedestrians or a large crowd in front
- The pedestrian is wearing clothing that easily blends into the background, making it difficult to detect
- The pedestrian is difficult to distinguish from the similar shaped structure in the surroundings
- You are driving by a pedestrian, traffic sign, structure, etc. near the intersection
- Driving in a parking lot
- Driving through a tollgate, construction area, unpaved road, partial paved road, uneven road, speed bumps, etc.
- Driving on an incline road, curved road, etc.
- Driving through a roadside with trees or streetlights
- The adverse road conditions cause excessive vehicle vibrations while driving
- Your vehicle height is low or high due to heavy loads, abnormal tire pressure, etc.
- Driving through a narrow road where trees or grass or overgrown
- There is interference by electromagnetic waves such as driving in an area with strong radio waves or electrical noise

### **WARNING**

- **Driving on a curve**

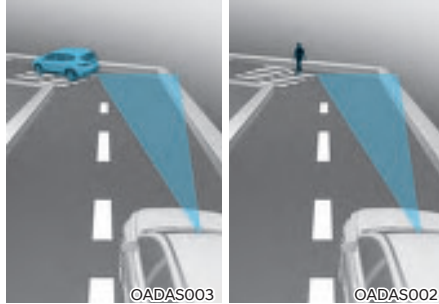

**Forward Collision-Avoidance Assist may not detect other vehicles or pedestrians in front of you on curved roads adversely affecting the performance of the sensors. This may result in no warning or braking assist when necessary.**

**When driving on a curve, you must maintain a safe braking distance, and if necessary, steer the vehicle and depress the brake pedal to reduce your driving speed in order to maintain a safe distance.**

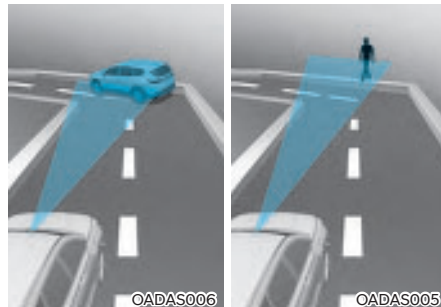

**Forward Collision-Avoidance Assist may detect a vehicle or pedestrian in the next lane or outside the lane when driving on a curved road.**

**If this occurs, the system may unnecessarily warn the driver and control the brake. Always check the traffic conditions around the vehicle.**

- **Driving on a slope**

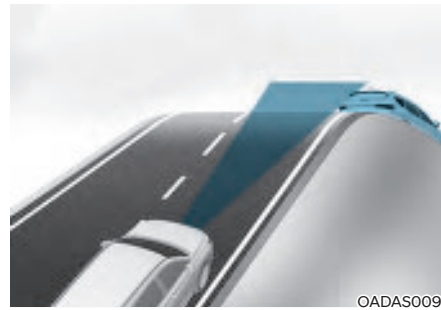

**Forward Collision-Avoidance Assist may not detect other vehicles or pedestrians in front of you while driving uphill or downhill adversely affecting the performance of the sensors.**

**This may result in unnecessary warning or braking assist, or no warning or braking assist when necessary.**

**Also, vehicle speed may rapidly decrease when a vehicle or pedestrian ahead is suddenly detected.**

**Always have your eyes on the road while driving uphill or downhill and if necessary, steer the vehicle and depress the brake pedal to reduce your driving speed in order to maintain a safe distance.**

• Changing lanes

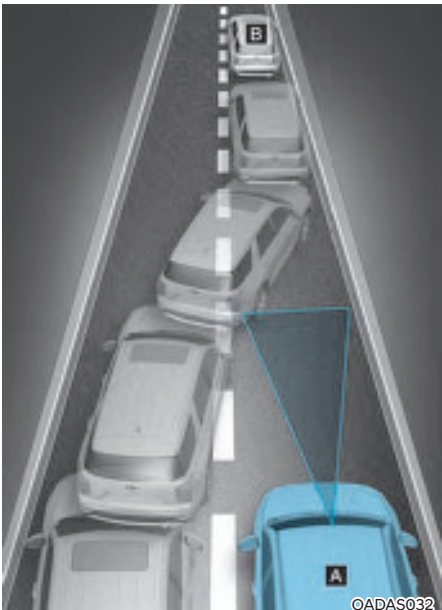

[A] : Your vehicle,  
[B] : Lane changing vehicle

**When a vehicle moves into your lane from an adjacent lane, it cannot be detected by the sensor until it is in the sensor's detection range. Forward Collision-Avoidance Assist may not immediately detect the vehicle when the vehicle changes lanes abruptly. In this case, you must maintain a safe braking distance, and if necessary, steer the vehicle and depress the brake pedal to reduce your driving speed in order to maintain a safe distance.**

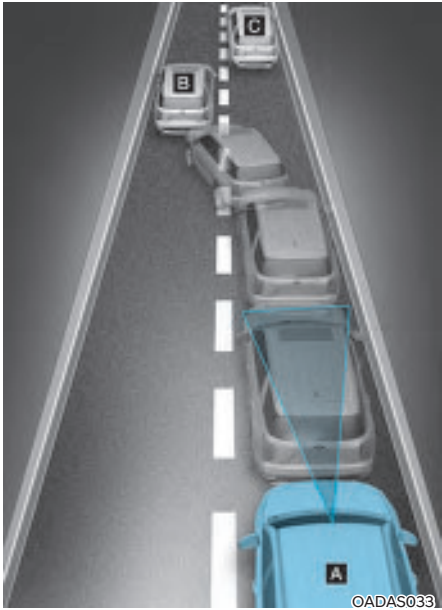

[A] : Your vehicle,  
[B] : Lane changing vehicle,  
[C] : Same lane vehicle

**When a vehicle in front of you merges out of the lane, Forward Collision-Avoidance Assist may not immediately detect the vehicle that is now in front of you.**

**In this case, you must maintain a safe braking distance, and if necessary, steer the vehicle and depress the brake pedal to reduce your driving speed in order to maintain a safe distance.**

- Detecting vehicle

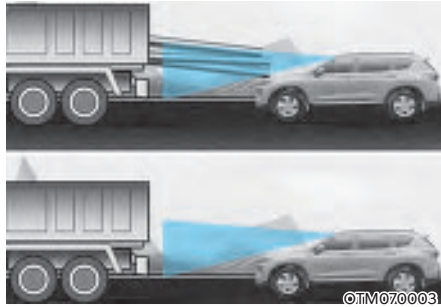

If the vehicle in front of you has cargo that extends rearward from the cab, or when the vehicle in front of you has higher ground clearance, additional special attention is required. Forward Collision-Avoidance Assist may not be able to detect the cargo extending from the vehicle. In these instances, you must maintain a safe braking distance from the rearmost object, and if necessary, steer the vehicle and depress the brake pedal to reduce your driving speed in order to maintain distance.

### WARNING

- When you are towing a trailer or another vehicle, we recommend that Forward Collision-Avoidance Assist is turned off due to safety reasons.
- Forward Collision-Avoidance Assist may operate if objects that are similar in shape or characteristics to vehicles and pedestrians are detected.
- Forward Collision-Avoidance Assist does not operate on bicycles, motorcycles, or smaller wheeled objects, such as luggage bags, shopping carts, or strollers.

- Forward Collision-Avoidance Assist may not operate normally if interfered by strong electromagnetic waves.
- Forward Collision-Avoidance Assist may not operate for 15 seconds after the vehicle is started, or the front view camera is initialized.

### Information

This device complies with Part 15 of the FCC rules.

Operation is subject to the following three conditions:

1. This device may not cause harmful interference, and
2. This device must accept any interference received, including interference that may cause undesired operation.
3. Changes or modifications not expressly approved by the party responsible for compliance could void the user's authority to operate the device.

### Information

Radio frequency radiation exposure information:

This equipment complies with FCC radiation exposure limits set forth for an uncontrolled environment.

This equipment should be installed and operated with minimum distance of 8 in. (20 cm) between the radiator (antenna) and your body.

This transmitter must not be co-located or operating in conjunction with any other antenna or transmitter.

## FORWARD COLLISION-AVOIDANCE ASSIST (FCA) (SENSOR FUSION) (IF EQUIPPED)

### Basic function

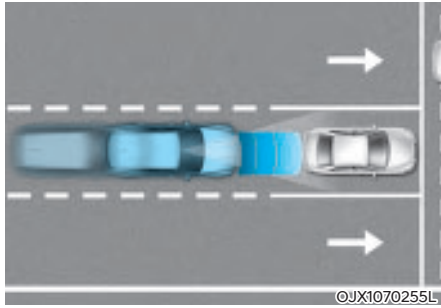

Forward Collision-Avoidance Assist is designed to help detect and monitor the vehicle ahead or help detect a pedestrian or cyclist in the roadway and warn the driver that a collision is imminent with a warning message and an audible warning, and if necessary, apply emergency braking.

### Junction Turning function (if equipped)

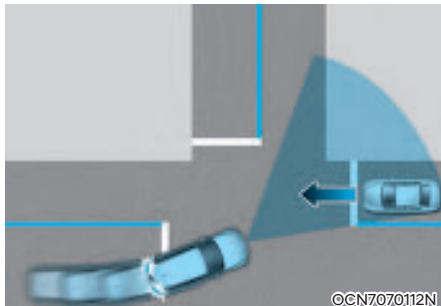

Junction Turning function will help avoid a collision with an oncoming vehicle in an adjacent lane when turning left at a crossroad with the turn signal on by applying emergency braking.

### Detecting sensor



[1] : Front view camera,  
[2] : Front radar

Refer to the picture above for the detailed location of the detecting sensors.

**CAUTION**

Take the following precautions to maintain optimal performance of the detecting sensor:

- Never disassemble the detecting sensor or sensor assembly, or apply any impact on it.
- If the detecting sensors have been replaced or repaired, we recommend that you have your vehicle inspected by an authorized HYUNDAI dealer.
- Never install any accessories or stickers on the front windshield, or tint the front windshield.
- Pay extreme caution to keep the front view camera dry.
- Never place any reflective objects (i.e. white paper, mirror) over the dashboard. Any light reflection may prevent the system from functioning properly.
- Do not apply license plate frame or objects, such as a bumper sticker, film or a bumper guard, near the front radar cover.
- Always keep the front radar and cover clean and free of dirt and debris.

Use only a soft cloth to wash the vehicle. Do not spray pressurized water directly on the sensor or sensor cover.

- If excessive force has been applied to the radar or around the radar, Forward Collision-Avoidance Assist may not properly operate even though a warning message does not appear on the cluster. We recommend that the vehicle be inspected by an authorized HYUNDAI dealer.
- Use only genuine parts to repair or replace a damaged front radar cover. Do not apply paint to the front radar cover.

## Function settings

### Setting



#### Forward Safety

With the engine on, select 'Driver Assistance → Forward Safety' from the Settings menu to set whether or not to use each function.

- If 'Active Assist' is selected, the function will warn the driver with a warning message and an audible warning depending on the collision risk levels. Braking assist will be applied depending on the collision risk.
- If 'Warning Only' is selected, the function will warn the driver with a warning message and an audible warning depending on the collision risk levels. Braking will not be assisted.
- If 'Off' is selected, the function will turn off. The  warning light will illuminate on the cluster.

The driver can monitor Forward Collision-Avoidance Assist ON/OFF status from the Settings menu. If the  warning light remains ON when the system is ON, we recommend that the system be inspected by an authorized HYUNDAI dealer.

### WARNING

When the engine is restarted, Forward Collision-Avoidance Assist will always turn on. However, if 'Off' is selected after the engine is restarted, the driver should always be aware of the surroundings and drive safely.

### CAUTION

- If 'Warning Only' is selected, braking is not assisted.
- The settings for Forward Safety include 'Basic function' and 'Junction Turning' (if equipped).

### Information

Forward Collision-Avoidance Assist will turn off when ESC is turned off by pressing and holding the ESC OFF button for more than 3 seconds. The  warning light will illuminate on the cluster.



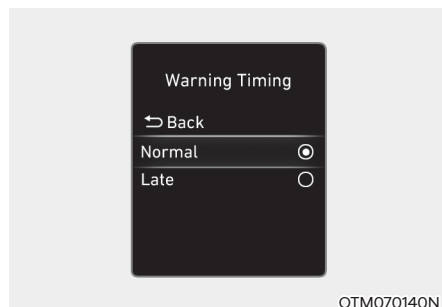

### Warning Timing

With the engine on, select 'Driver Assistance → Warning Timing' from the Settings menu to change the initial warning activation time for Forward Collision-Avoidance Assist.

When the vehicle is first delivered, Warning Timing is set to 'Normal'. If you change the Warning Timing, the warning time of other Driver Assistance systems may change.

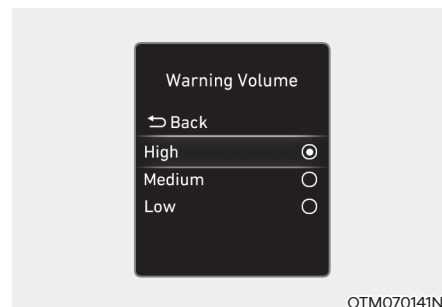

### Warning Volume

With the engine on, select 'Driver Assistance → Warning Volume' from the Settings menu to change the Warning Volume to 'High', 'Medium' or 'Low' for Forward Collision-Avoidance Assist.

If you change the warning volume, the Warning Volume of other Driver Assistance systems may change.



### CAUTION

- The setting of the Warning Timing and Warning Volume applies to all functions of Forward Collision-Avoidance Assist.
- Even though 'Normal' is selected for Warning Timing, if the front vehicle suddenly stops, the initial warning activation time may seem late.
- Select 'Late' for Warning Timing when traffic is light and when driving speed is slow.



### Information

If the engine is restarted, Warning Timing and Warning Volume will maintain the last setting.

## Function operation

### Basic function

#### Function warning and control

The basic function for Forward Collision-Avoidance Assist is to help warn and control the vehicle depending on the collision risk level : 'Collision Warning', 'Emergency Braking' and 'Stopping vehicle and ending brake control'.

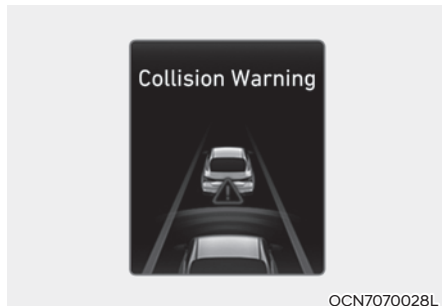

#### Collision Warning

- To warn the driver of a collision, the 'Collision Warning' warning message will appear on the cluster and an audible warning will sound.
- If a vehicle is detected in front, the system will operate when your vehicle speed is between approximately 6~112 mph (10~180 km/h).
- If a pedestrian or cyclist is detected in front, the system will operate when your vehicle speed is between approximately 6~53 mph (10~85 km/h).
- If 'Active Assist' is selected, braking may be assisted.

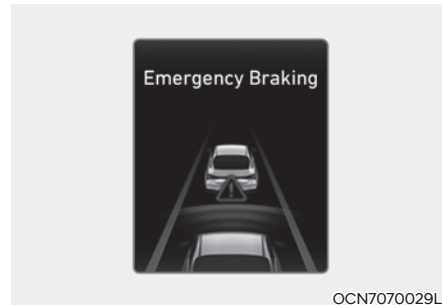

#### Emergency Braking

- To warn the driver that emergency braking will be assisted, the 'Emergency Braking' warning message will appear on the cluster and an audible warning will sound.
- If a vehicle is detected in front, the system will operate when your vehicle speed is between approximately 6~47 mph (10~75 km/h).
- If a pedestrian or cyclist is detected in front, the system will operate when your vehicle speed is between approximately 6~40 mph (10~65 km/h).
- In emergency braking situation, braking is assisted with strong braking power by the system to help prevent collision with the vehicle, pedestrian or cyclist ahead.



#### Stopping vehicle and ending brake control

- When the vehicle is stopped due to emergency braking, the 'Drive carefully' warning message will appear on the cluster.  
For your safety, the driver should depress the brake pedal immediately and check the surroundings.
- Brake control will end after the vehicle is stopped by emergency braking for approximately 2 seconds.

#### Junction Turning function (if equipped)

##### Function warning and control

Junction Turning function will help warn and control the vehicle depending on the collision risk level : 'Collision Warning', 'Emergency Braking' and 'Stopping vehicle and ending brake control'



#### Collision Warning

- To warn the driver of a collision, the 'Collision Warning' warning message will appear on the cluster and an audible warning will sound.
- The function will operate when your vehicle speed is between approximately 6~19 mph (10~30 km/h) and the oncoming vehicle speed is between approximately 19~44 mph (30~70 km/h).
- If 'Active Assist' is selected, braking may be assisted.



#### Emergency Braking

- To warn the driver that emergency braking will be assisted, the 'Emergency Braking' warning message will appear on the cluster and an audible warning will sound.
- The system will operate when your vehicle speed is between approximately 6~19 mph (10~30 km/h) and the oncoming vehicle speed is between approximately 19~44 mph (30~70 km/h).
- In emergency braking situation, braking is assisted with strong braking power by the system to help prevent collision with the oncoming vehicle.



#### Stopping vehicle and ending brake control

- When the vehicle is stopped due to emergency braking, the 'Drive carefully' warning message will appear on the cluster.  
For your safety, the driver should depress the brake pedal immediately and check the surroundings.
- Brake control will end after the vehicle is stopped by emergency braking for approximately 2 seconds.

#### **i** Information

**If the driver's seat is on the left side, Junction Turning function will operate only when the driver turns left. If the driver's seat position is on right side, the function will operate only when you turn right.**

**WARNING**

Take the following precautions when using Forward Collision-Avoidance Assist:

- For your safety, change the Settings after parking the vehicle at a safe location.
- With 'Active Assist' or 'Warning Only' selected, when ESC is turned off by pressing and holding the ESC OFF button for more than 3 seconds, Forward Collision-Avoidance Assist will turn off automatically. In this case, the function cannot be set from the Settings menu and the warning light will illuminate on the cluster which is normal. If ESC is turned on by pressing the ESC OFF button, Forward Collision-Avoidance Assist will maintain the last setting.
- Forward Collision-Avoidance Assist does not operate in all situations or cannot avoid all collisions.
- The driver should hold the responsibility to control the vehicle. Do not solely depend on Forward Collision-Avoidance Assist. Rather, maintain a safe braking distance, and if necessary, depress the brake pedal to reduce driving speed or to stop the vehicle.
- Never deliberately operate Forward Collision-Avoidance Assist on people, animal, objects, etc. It may cause serious injury or death.
- Forward Collision-Avoidance Assist may not operate if the driver depresses the brake pedal to avoid collision.
- Depending on the road and driving conditions, Forward Collision-Avoidance Assist may warn the driver late or may not warn the driver.
- During Forward Collision-Avoidance Assist operation, the vehicle may stop suddenly injuring passengers and shifting loose objects. Always have the seat belt on and keep loose objects secured.
- If any other function's warning message is displayed or audible warning is generated, Forward Collision-Avoidance Assist warning message may not be displayed and audible warning may not be generated.
- You may not hear the warning sound of Forward Collision-Avoidance Assist if the surrounding is noisy.
- Forward Collision-Avoidance Assist may turn off or may not operate properly or may operate unnecessarily depending on the road conditions and the surroundings.

**WARNING**

- Even if there is a problem with Forward Collision-Avoidance Assist, the vehicle's basic braking performance will operate normally.
- During emergency braking, braking control by the function will automatically cancel when the driver excessively depresses the accelerator pedal or sharply steers the vehicle.

 **CAUTION**

- Forward Collision-Avoidance Assist operating speed range may reduce due to the conditions of the vehicle or pedestrian in front or surroundings. Depending on the speed, the system may only warn the driver, or the system may not operate.
- Forward Collision-Avoidance Assist will operate under certain conditions by judging the risk level based on the condition of the oncoming vehicle, driving direction, speed and surroundings.



 **Information**

In a situation where collision is imminent, braking may be assisted by Forward Collision-Avoidance Assist when braking is insufficient by the driver.

## Function malfunction and limitations



### *Function malfunction*

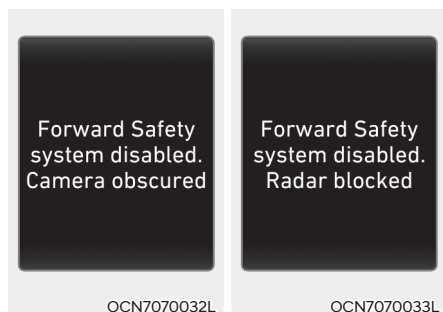

When Forward Collision-Avoidance Assist is not working properly, the 'Check Forward Safety system(s)' warning message will appear, and the  and  warning lights will illuminate on the cluster. We recommend that the function be inspected by an authorized HYUNDAI dealer.

**System disabled**

When the front windshield where the front view camera is located, front radar cover, bumper or sensor is covered with foreign material, such as snow or rain, it can reduce the detecting performance and temporarily limit or disable Forward Collision-Avoidance Assist.

If this occurs the 'Forward Safety system(s) disabled. Camera obscured' or the 'Forward Safety system(s) disabled. Radar blocked' warning message, and the  and  warning lights will illuminate on the cluster.

The function will operate normally when such snow, rain or foreign material is removed.

If the function does not operate normally after obstruction (snow, rain, or foreign material) is removed, we recommend that the function be inspected by an authorized HYUNDAI dealer.

** WARNING**

- Even though the warning message or warning light does not appear on the cluster, Forward Collision-Avoidance Assist may not properly operate.
- Forward Collision-Avoidance Assist may not properly operate in an area (e.g. open terrain), where any objects are not detected after turning ON the engine.

**Limitations of the function**

Forward Collision-Avoidance Assist may not operate normally, or the function may operate unexpectedly under the following circumstances:

- The detecting sensor or the surroundings are contaminated or damaged
- The temperature around the front view camera is high or low
- The camera lens is contaminated due to tinted, filmed or coated windshield, damaged glass, or stuck of foreign material (sticker, bug, etc.) on the glass
- Moisture is not removed or frozen on the windshield
- Washer fluid is continuously sprayed, or the wiper is on
- Driving in heavy rain or snow, or thick fog
- The field of view of the front view camera is obstructed by sun glare
- Street light or light from an oncoming vehicle is reflected on the wet road surface, such as a puddle on the road
- An object is placed on the dashboard

- Your vehicle is being towed
- The surrounding is very bright
- The surrounding is very dark, such as in a tunnel, etc.
- The brightness changes suddenly, for example when entering or exiting a tunnel
- The brightness outside is low, and the headlamps are not on or are not bright
- Driving through steam, smoke or shadow
- Only part of the vehicle, pedestrian or cyclist is detected
- The vehicle in front is a bus, heavy truck, truck with a unusually shaped luggage, trailer, etc.
- The vehicle in front has no tail lights, tail lights are located unusually, etc.
- The brightness outside is low, and the tail lamps are not on or are not bright
- The rear of the front vehicle is small or the vehicle does not look normal, such as when the vehicle is tilted, overturned, or the side of the vehicle is visible, etc.
- The front vehicle's ground clearance is low or high
- A vehicle, pedestrian or cyclist suddenly cuts in front
- The bumper around the front radar is impacted, damaged or the front radar is out of position
- The temperature around the front radar is high or low
- Driving through a tunnel or iron bridge
- Driving in large areas where there are few vehicles or structures (i.e. desert, meadow, suburb, etc.)
- Driving near areas containing metal substances, such as a construction zone, railroad, etc.
- A material is near that reflects very well on the front radar, such as a guardrail, nearby vehicle, etc.
- The cyclist in front is on a bicycle made of material that does not reflect on the front radar
- The vehicle in front is detected late
- The vehicle in front is suddenly blocked by an obstacle
- The vehicle in front suddenly changes lane or suddenly reduces speed
- The vehicle in front is bent out of shape
- The front vehicle's speed is fast or slow
- The vehicle in front steers in the opposite direction of your vehicle to avoid a collision
- With a vehicle in front, your vehicle changes lane at low speed
- The vehicle in front is covered with snow
- You are departing or returning to the lane
- Unstable driving
- You are on a roundabout and the vehicle in front is not detected
- You are continuously driving in a circle
- The vehicle in front has an unusual shape
- The vehicle in front is driving uphill or downhill



- The pedestrian or cyclist is not fully detected, for example, if the pedestrian is leaning over or is not fully walking upright
- The pedestrian or cyclist is wearing clothing or equipment that makes it difficult to detect as a pedestrian or cyclist



The illustration above shows the image the front view camera will detect as a vehicle, pedestrian and cyclist.

- The pedestrian or cyclist in front is moving very quickly
- The pedestrian or cyclist in front is short or is posing a low posture
- The pedestrian or cyclist in front has impaired mobility
- The pedestrian or cyclist in front is moving intersected with the driving direction
- There is a group of pedestrians, cyclists or a large crowd in front
- The pedestrian or cyclist is wearing clothing that easily blends into the background, making it difficult to detect
- The pedestrian or cyclist is difficult to distinguish from the similar shaped structure in the surroundings
- You are driving by a pedestrian, cyclist, traffic sign, structure, etc. near the intersection
- Driving in a parking lot
- Driving through a tollgate, construction area, unpaved road, partial paved road, uneven road, speed bumps, etc.
- Driving on an incline road, curved road, etc.
- Driving through a roadside with trees or streetlights
- The adverse road conditions cause excessive vehicle vibrations while driving
- Your vehicle height is low or high due to heavy loads, abnormal tire pressure, etc.
- Driving through a narrow road where trees or grass are overgrown
- There is interference by electromagnetic waves, such as driving in an area with strong radio waves or electrical noise

 **WARNING**

- Driving on a curve

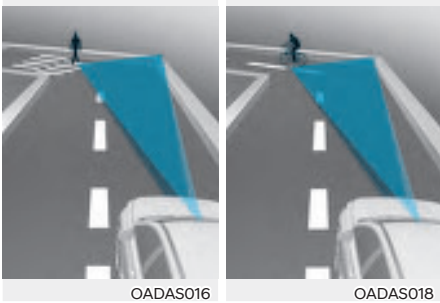
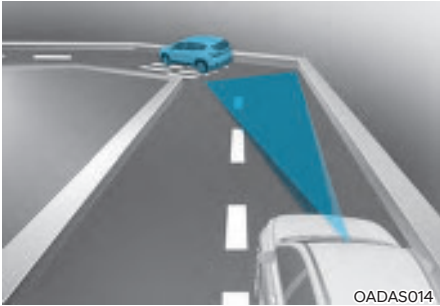

Forward Collision-Avoidance Assist may not detect other vehicles, pedestrians or cyclists in front of you on curved roads adversely affecting the performance of the sensors. This may result in no warning or braking assist when necessary.

When driving on a curve, you must maintain a safe braking distance, and if necessary, steer the vehicle and depress the brake pedal to reduce your driving speed in order to maintain a safe distance.



Forward Collision-Avoidance Assist may detect a vehicle, pedestrian or cyclist in the next lane or outside the lane when driving on a curved road.

If this occurs, the system may unnecessarily warn the driver and control the brake. Always check the traffic conditions around the vehicle.

- Driving on a slope

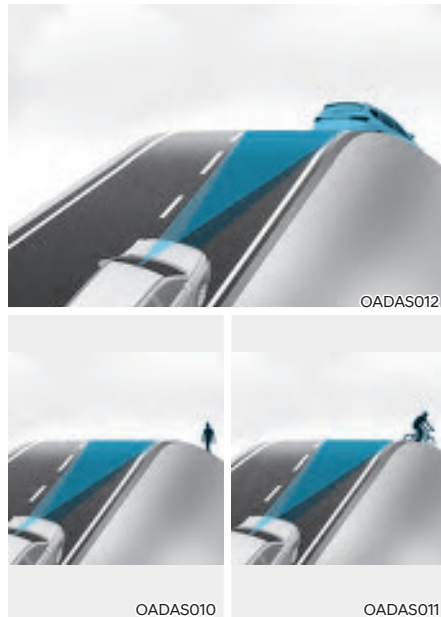

**Forward Collision-Avoidance Assist may not detect other vehicles, pedestrians or cyclists in front of you while driving uphill or downhill adversely affecting the performance of the sensors.**

**This may result in unnecessary warning or braking assist, or no warning or braking assist when necessary.**

**Also, vehicle speed may rapidly decrease when a vehicle, pedestrian or cyclist ahead is suddenly detected.**

**Always have your eyes on the road while driving uphill or downhill and if necessary, steer your vehicle and depress the brake pedal to reduce your driving speed in order to maintain a safe distance.**

- Changing lanes



[A] : Your vehicle,  
[B] : Lane changing vehicle

**When a vehicle moves into your lane from an adjacent lane, it cannot be detected by the sensor until it is in the sensor's detection range. Forward Collision-Avoidance Assist may not immediately detect the vehicle when the vehicle changes lanes abruptly. In this case, you must maintain a safe braking distance, and if necessary, steer your vehicle and depress the brake pedal to reduce your driving speed in order to maintain a safe distance.**

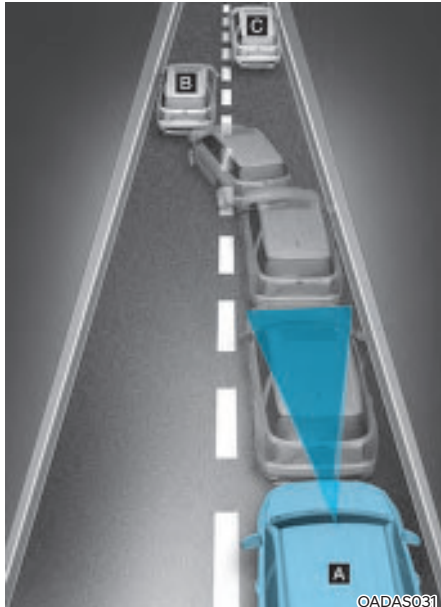

[A] : Your vehicle, [B] : Lane changing vehicle,  
[C] : Same lane vehicle

**When a vehicle in front of you merges out of the lane, Forward Collision-Avoidance Assist may not immediately detect the vehicle that is now in front of you. In this case, you must maintain a safe braking distance, and if necessary, steer your vehicle and depress the brake pedal to reduce your driving speed in order to maintain a safe distance.**

- **Detecting vehicle**

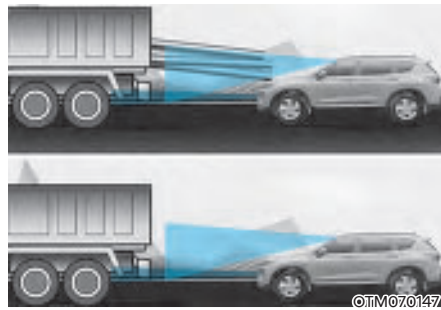

**If the vehicle in front of you has cargo that extends rearward from the cab, or when the vehicle in front of you has higher ground clearance, additional special attention is required. Forward Collision-Avoidance Assist may not be able to detect the cargo extending from the vehicle. In these instances, you must maintain a safe braking distance from the rearmost object, and if necessary, steer your vehicle and depress the brake pedal to reduce your driving speed in order to maintain distance.**

 **WARNING**

- When you are towing a trailer or another vehicle, we recommend that Forward Collision-Avoidance Assist is turned off due to safety reasons.
- Forward Collision-Avoidance Assist may operate if objects that are similar in shape or characteristics to vehicles, pedestrians and cyclists are detected.
- Forward Collision-Avoidance Assist does not operate on bicycles, motorcycles, or smaller wheeled objects, such as luggage bags, shopping carts, or strollers.
- Forward Collision-Avoidance Assist may not operate normally if interfered by strong electromagnetic waves.
- Forward Collision-Avoidance Assist may not operate for 15 seconds after the vehicle is started, or the front view camera is initialized.

 **Information**

This device complies with Part 15 of the FCC rules.

Operation is subject to the following three conditions:

1. This device may not cause harmful interference, and
2. This device must accept any interference received, including interference that may cause undesired operation.
3. Changes or modifications not expressly approved by the party responsible for compliance could void the user's authority to operate the device.

 **Information**

Radio frequency radiation exposure information:

This equipment complies with FCC radiation exposure limits set forth for an uncontrolled environment.

This equipment should be installed and operated with minimum distance of 8 in. (20 cm) between the radiator (antenna) and your body.

This transmitter must not be co-located or operating in conjunction with any other antenna or transmitter.

## LANE KEEPING ASSIST (LKA)

Lane Keeping Assist is designed to help detect lane markings (or road edges) while driving over a certain speed. The system will warn the driver if the vehicle leaves the lane without using the turn signal, or will automatically assist the driver's steering to help prevent the vehicle from departing the lane.

### Detecting sensor



[1] : Front view camera

The front view camera is used as a detecting sensor to detect lane markings (or road edges).

Refer to the picture above for the detailed location of the detecting sensor.



### CAUTION

For more details on the precautions of the front view camera, refer to “Forward Collision-Avoidance Assist (FCA)” section in chapter 7.

## Function settings

### Setting

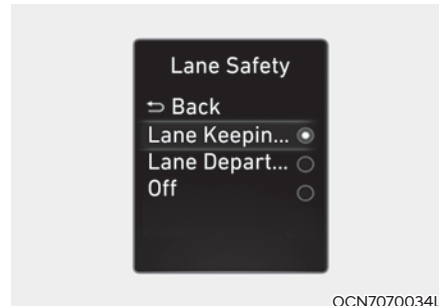

### Lane Safety

With the Engine Start/Stop button in the ON position, select or deselect 'Driver Assistance → Lane Safety' from the Settings menu to set whether or not to use each function.

- If 'Lane Keeping Assist' is selected, the function will automatically assist the driver's steering when lane departure is detected to help prevent the vehicle from moving out of its lane.
- If 'Lane Departure Warning' is selected, the function will warn the driver with an audible warning and steering wheel vibration when lane departure is detected. The driver must steer the vehicle.
- If 'Off' is selected, the function will turn off. The  indicator light will turn off on the cluster.



### WARNING

- If 'Lane Departure Warning' is selected, steering is not assisted.
- Lane Keeping Assist does not control the steering wheel when the vehicle is driven in the middle of the lane.
- The driver should always be aware of the surroundings and steer the vehicle if 'Off' is selected.

#### Turning the function On/Off (Lane Safety button)



With the engine on, press and hold the Lane Safety button located on the instrument panel to turn on Lane Keeping Assist. The white  indicator light will illuminate on the cluster.

Press the button again to turn off the system.

If the engine is restarted, Lane Keeping Assist will maintain the last setting.

#### Information

When Lane Keeping Assist is turned off with the Lane Safety button, Lane Safety settings will turn off.

#### Turning the Function On/Off (Lane Driving Assist button)

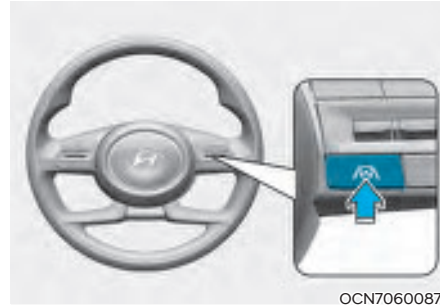

With the engine on, press and hold the Lane Driving Assist button located on the steering wheel to turn on Lane Keeping Assist. The white  indicator light will illuminate on the cluster.

Press the button again to turn off the system.

If the engine is restarted, Lane Keeping Assist will maintain the last setting.

#### CAUTION

When the Lane Driving Assist button is pressed shortly, Lane Following Assist will turn on and off.

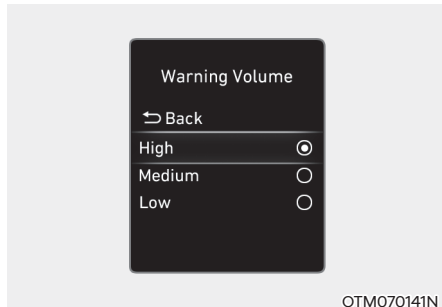

### Warning Volume

With the engine on, select 'Driver Assistance → Warning Volume' from the Settings menu to change the Warning Volume to 'High', 'Medium' or 'Low' for Lane Keeping Assist.

If you change the Warning Volume, the Warning Volume of other Driver Assistance systems may be changed.

## Function operation

### Function warning and control

Lane Keeping Assist will help warn and control the vehicle with Lane Departure Warning and Lane Keeping Assist.

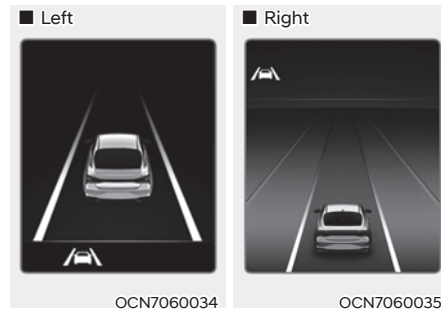

### Lane Departure Warning

- To warn the driver that the vehicle is departing from the projected lane in front, the green  indicator light will blink on the cluster, the lane line will blink on the cluster depending on which direction the vehicle is veering, and an audible warning will sound.
- The system will operate when your vehicle speed is between approximately 40~120 mph (60~200 km/h).



### Lane Keeping Assist

- To warn the driver that the vehicle is departing from the projected lane in front, the green  indicator light will blink on the cluster, and the steering wheel will make adjustments to help keep the vehicle inside the lane.
- The function will operate when your vehicle speed is between approximately 40–120 mph (60–200 km/h).

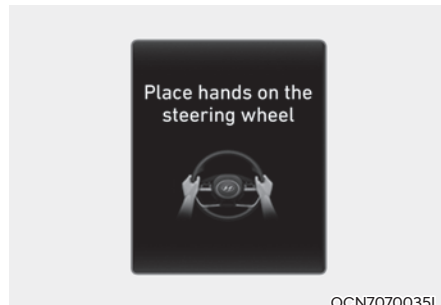

### Hands-off warning

If the driver takes their hands off the steering wheel for several seconds, the 'Place hands on the steering wheel' warning message will appear on the cluster, and an audible warning will sound in stages.

### WARNING

- The steering wheel may not be assisted if the steering wheel is held very tight or the steering wheel is steered over a certain degree.
- Lane Keeping Assist does not operate at all times. It is the responsibility of the driver to safely steer the vehicle and to maintain the vehicle in its lane.
- The hands-off warning message may appear late depending on road conditions. Always have your hands on the steering wheel while driving.
- If the steering wheel is held very lightly, the hands-off warning message may appear because the system may not recognize that the driver has their hands on the steering wheel.
- If you attach objects to the steering wheel, the hands-off warning may not work properly.

**i** Information

- For more details on setting the functions in the infotainment system, refer to “Vehicle Settings” section in chapter 4.
- When lane markings (or road edges) are detected, the lane lines on the cluster will change from grey to white and the green  indicator light will illuminate.

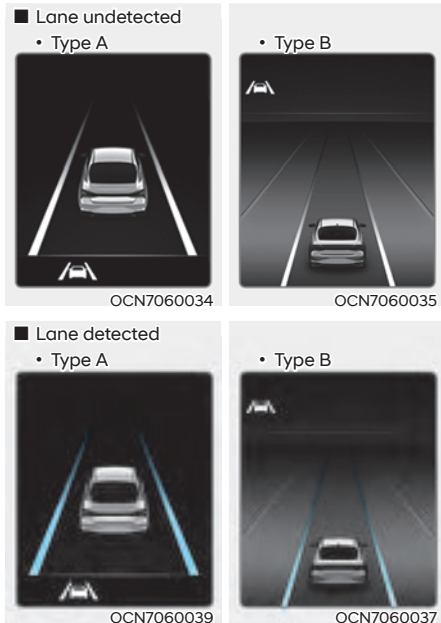

- Even though the steering is assisted by Lane Keeping Assist, the driver may control the steering wheel.
- The steering wheel may feel heavier or lighter when the steering wheel is assisted by Lane Keeping Assist than when it is not.

**Function malfunction and limitations**

**Function malfunction**



When Lane Keeping Assist is not working properly, the ‘Check Lane Keeping Assist (LKA) system’ warning message will appear and the yellow  indicator light will illuminate on the cluster. If this occurs, we recommend that the system be inspected by an authorized HYUNDAI dealer.

**Limitations of the function**

Lane Keeping Assist may not operate normally or may operate unexpectedly under the following circumstances:

- The lane is contaminated or difficult to distinguish because,
  - The lane markings (or road edges) is covered with rain, snow, dirt, oil, etc.
  - The color of the lane marking (or road edges) is not distinguishable from the road
  - There are markings (or road edges) on the road near the lane or the markings (or road edges) on the road looks similar to the lane markings (or road edges)
  - The lane marking (or road edges) is indistinct or damaged
  - The shadow is on the lane marking (or road edges) by a median strip, trees, guardrail, noise barriers, etc.

- There are more than two lane markings (or road edges) on the road
- The lane number increases or decreases, or the lane markings (or road edges) are crossing
- The lane markings (or road edges) are complicated or a structure substitutes for the lines, such as a construction area
- There are road markings, such as zigzag lanes, crosswalk markings and road signs
- The lane suddenly disappears, such as at the intersection
- The lane (or road width) is very wide or narrow
- There is a boundary structure in the roadway, such as a tollgate, sidewalk, curb, etc.
- The distance to the front vehicle is extremely short or the vehicle in front is covering the lane marking

**For more details on the limitations of the front view camera, refer to “Forward Collision-Avoidance Assist (FCA)” section in chapter 7.**



## **WARNING**

**Take the following precautions when using Lane Keeping Assist:**

- **The driver should hold the responsibility to safely drive and control the vehicle. Do not solely rely on the system and drive dangerously.**
- **The operation of Lane Keeping Assist can be cancelled or not work properly depending on road conditions and surroundings. Always be cautious while driving.**
- **Refer to “Limitations of the System” if the lane is not detected properly.**
- **When you are towing a trailer or another vehicle, we recommend that Lane Keeping Assist is turned off due to safety reasons.**
- **If the vehicle is driven at high speed, the steering wheel will not be controlled. The driver must always follow the speed limit when using the system.**
- **If any other system’s warning message is displayed or audible warning is generated, Lane Keeping Assist warning message may not be displayed and audible warning may not be generated.**
- **You may not hear the warning sound of Lane Keeping Assist if the surrounding is noisy.**
- **If you attach objects to the steering wheel, steering may not be assisted properly.**
- **Lane Keeping Assist may not operate for 15 seconds after the vehicle is started, or the front view camera is initialized.**

- **Lane Keeping Assist will not operate when:**
  - **The turn signal or hazard warning flasher is turned on**
  - **The vehicle is not driven in the center of the lane when the system is turned on or right after changing a lane**
  - **ESC (Electronic Stability Control) or VSM (Vehicle Stability Management) is activated**
  - **The vehicle is driven on a sharp curve**
  - **Vehicle speed is below 35 mph (55 km/h) or above 130 mph (210 km/h)**
  - **The vehicle makes sharp lane changes**
  - **The vehicle brakes suddenly**

## BLIND-SPOT COLLISION WARNING (BCW) (IF EQUIPPED)

Blind-Spot Collision Warning is designed to help detect and monitor approaching vehicles in the driver's blind spot area and warn the driver of a possible collision with a warning message and audible warning.

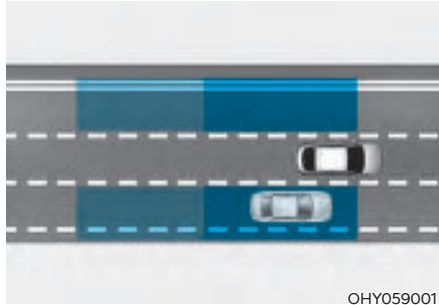

OHY059001

Blind-Spot Collision Warning helps detect and inform the driver that a vehicle is in the blind spot.



### CAUTION

The detecting range may vary depending on the speed of your vehicle. However, even if there is a vehicle in the blind spot, the system may not warn you when you pass by at high speed.

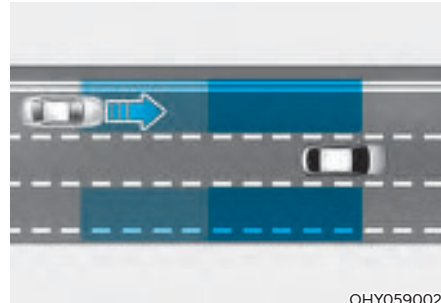

OHY059002

Blind-Spot Collision Warning helps detect and informs the driver that a vehicle is approaching at high speed from the blind spot area.



### CAUTION

Warning timing may vary depending on the speed of the vehicle approaching at high speed.



### Information

In the following text, Blind-Spot Collision Warning system will be referred as Blind-Spot Safety system.

### Detecting sensor



[1] : Rear corner radar

Refer to the picture above for the detailed location of the detecting sensor.



### CAUTION

Take the following precautions to maintain optimal performance of the detecting sensor:

- Never disassemble the rear corner radar or radar assembly, or apply any impact on it.
- If the rear corner radars have been replaced or repaired, we recommend that the vehicle be inspected by an authorized HYUNDAI dealer.
- If there is impact on the rear corner radar or near the radar, even though the warning message does not appear on the cluster, Blind-Spot Safety system may not operate properly. We recommend that the system be inspected by an authorized HYUNDAI dealer.
- Use only genuine parts to repair the rear bumper where the rear corner radar is located.
- Do not apply license plate frame or objects, such as a bumper sticker, film or a bumper guard near the rear corner radar.

- The system may not work properly if the bumper has been replaced, or the surroundings of the rear corner radar has been damaged or paint has been applied.
- If a trailer, carrier, etc. is installed, it may adversely affect the performance of the rear corner radar or the system may not operate.

### Function settings

#### Setting



#### Blind-Spot Safety

With the engine on, select or deselect 'Driver Assistance → Blind-Spot Safety' from the Settings menu to set whether or not to use each function.

- If 'Warning Only' is selected, the system will warn the driver with a warning message and an audible warning depending on the collision risk levels. Braking will not be assisted.
- If 'Off' is selected, the system will turn off.

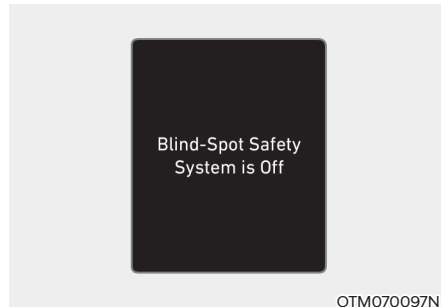

When the engine is restarted with the system off, the 'Blind-Spot Safety System is Off' message will appear on the cluster.

If you change the setting from 'Off' to 'Warning Only', the warning light on the outside rearview mirror will blink for three seconds.

In addition, if the engine is turned on, when the system is set to 'Warning Only', the warning light on the outside rearview mirror will blink for three seconds.



#### WARNING

- If 'Warning Only' is selected, braking is not assisted.
- If 'Off' is selected, the driver should always be aware of the surroundings and drive safely.



#### Information

If the engine is restarted, Blind-Spot Safety system will maintain the last setting.

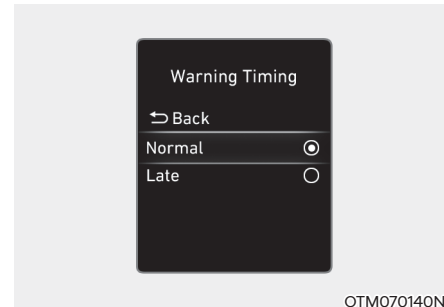

#### Warning Timing

With the engine on, select 'Driver Assistance → Warning Timing' from the Settings menu to change the initial warning activation time for Blind-Spot Safety system.

When the vehicle is first delivered, Warning Timing is set to 'Normal'. If you change the Warning Timing, the warning time of other Driver Assistance systems may change.

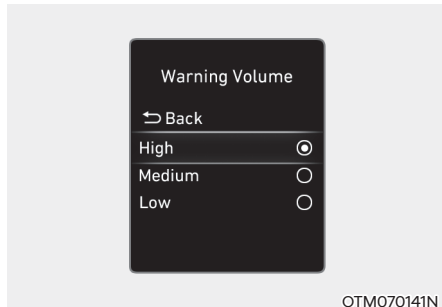

### Warning Volume

With the engine on, select 'Driver Assistance → Warning Volume' from the Settings menu to change the Warning Volume to 'High', 'Medium' or 'Low' for Blind-Spot Safety system.

If you change the Warning Volume, the warning volume of other Driver Assistance systems may change.



### CAUTION

- **The setting of the Warning Timing and Warning Volume applies to all functions of the Blind-Spot Safety system.**
- **Even though 'Normal' is selected for Warning Timing, if the vehicle approaches at high speed, the initial warning activation time may seem late.**
- **Select 'Late' for Warning Timing when traffic is light and when driving speed is slow.**

## Function operation

### Function warning



### Vehicle detection

- To warn the driver a vehicle is detected, the warning light on the outside rearview mirror will illuminate.
- The system will operate when your vehicle speed is above 12 mph (20 km/h) and the speed of the vehicle in the blind spot area is above 7 mph (10 km/h).

### Collision warning

- Collision warning will operate when the turn signal is turned on in the direction of the detected vehicle.
- If 'Warning Only' is selected from the Settings menu, the collision warning will operate when your vehicle approaches the lane the blind spot vehicle is detected.
- To warn the driver of a collision, the warning light on the outside rearview mirror will blink. At the same time, an audible warning will sound.
- When the turn signal is turned off or you move away from the lane, the collision warning will be canceled and the system will return to vehicle detection state.



 **WARNING**

- The detecting range of the rear corner radar is determined by the standard road width, therefore, on a narrow road, the system may detect other vehicles in the next next lane and warn you. In contrast, on a wide road, the system may not be able to detect a vehicle driving in the next lane and may not warn you.
- When the hazard warning light is on, the collision warning by the turn signal will not operate.

 **Information**

If the driver's seat is on the left side, the collision warning may occur when you turn left. Maintain a proper distance with the vehicles in the left lane. If the driver's seat is on the right side, the collision warning may occur when you turn right. Maintain a proper distance with the vehicles in the right lane.

 **WARNING**

Take the following precautions when using Blind-Spot Safety system:

- For your safety, change the Settings after parking the vehicle at a safe location.
- If any other system's warning message is displayed or audible warning is generated, Blind-Spot Safety system's warning message may not be displayed and audible warning may not be generated.
- You may not hear the warning sound of Blind-Spot Safety system if the surrounding is noisy.
- Blind-Spot Safety system may warn the driver late or may not warn the driver depending on the road and driving conditions.
- Driver should maintain control of the vehicle at all times. Do not depend on Blind-Spot Safety system. Maintain a safe braking distance, and if necessary, depress the brake pedal to reduce driving speed or to stop the vehicle.

## Function malfunction and limitations

### Function malfunction



When Blind-Spot Safety system is not working properly, the 'Check Blind-Spot Safety system(s)' warning message will appear on the cluster, and the system will turn off automatically, or the system will be limited. We recommend that the system be inspected by an authorized HYUNDAI dealer.

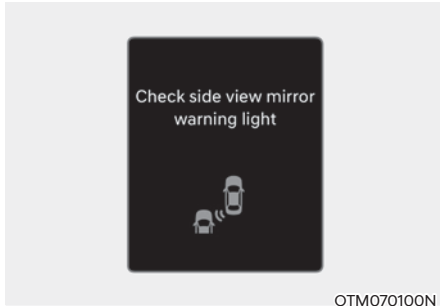

When the outside rearview mirror warning light is not working properly, the 'Check side view mirror warning light' warning message will appear on the cluster. We recommend that the system be inspected by an authorized HYUNDAI dealer.

### System disabled



When the rear bumper around the rear corner radar or sensor is covered with foreign material, such as snow or rain, or installing a trailer or carrier, it can reduce the detecting performance and temporarily limit or disable Blind-Spot Safety system.

If this occurs, the 'Blind-Spot Safety system(s) disabled. Radar blocked' warning message will appear on the cluster.

The system will operate normally when such foreign material or trailer, etc. is removed, and then the engine is restarted.

If the system does not operate normally after it is removed, we recommend that the system be inspected by an authorized HYUNDAI dealer.

**WARNING**

- Even though the warning message does not appear on the cluster, Blind-Spot Safety system may not properly operate.
- Blind-Spot Safety system may not properly operate in an area (e.g. open terrain), where any substance are not detected right after the engine is turned on, or when the detecting sensor is blocked with foreign material right after the engine is turned on.

**CAUTION**

Turn off Blind-Spot Safety system to install a trailer, carrier, etc., or remove the trailer, carrier, etc. to use Blind-Spot Safety system.

***Limitations of the function***

Blind-Spot Safety system may not operate normally, or the system may operate unexpectedly under the following circumstances:

- There is inclement weather, such as heavy snow, heavy rain, etc.
- The rear corner radar is covered with snow, rain, dirt, etc.
- The temperature around the rear corner radar is high or low
- Driving on a highway (or motorway) ramp
- The road pavement (or the peripheral ground) abnormally contains metallic components (i.e. possibly due to subway construction)
- There is a fixed object near the vehicle, such as sound barriers, guardrails, central dividers, entry barriers, street lamps, signs, tunnels, walls, etc. (including double structures)
- Driving in large areas where there are few vehicles or structures (i.e. desert, meadow, suburb, etc.)
- Driving through a narrow road where trees or grass are overgrown
- Driving on a wet road surface, such as a puddle on the road
- The other vehicle drives very close behind your vehicle, or the other vehicle passes by your vehicle in close proximity
- The speed of the other vehicle is very fast that it passes by your vehicle in a short time
- Your vehicle passes by the other vehicle
- Your vehicle changes lane
- Your vehicle has started at the same time as the vehicle next to you and has accelerated
- The vehicle in the next lane moves two lanes away from you, or when the vehicle two lanes away moves to the next lane from you
- A trailer or carrier is installed around the rear corner radar
- The bumper around the rear corner radar is covered with objects, such as a bumper sticker, bumper guard, bike rack, etc.
- The bumper around the rear corner radar is impacted, damaged or the radar is out of position
- Your vehicle height is low or high due to heavy loads, abnormal tire pressure, etc.

Blind-Spot Safety system may not operate normally, or the system may operate unexpectedly when the following objects are detected:

- A motorcycle or bicycle is detected
- A vehicle such as a flat trailer is detected
- A big vehicle such as a bus or truck is detected
- A moving obstacle such as a pedestrian, animal, shopping cart or a baby stroller is detected
- A vehicle with low height such as a sports car is detected

 **WARNING**

- **Driving on a curve**

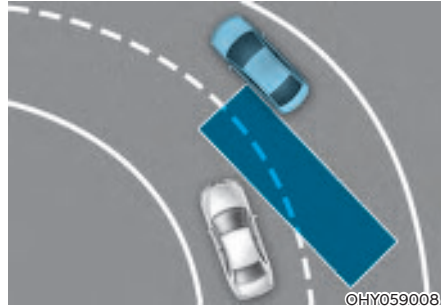

**Blind-Spot Safety system may not operate properly when driving on a curved road. The system may not detect the vehicle in the next lane.**

**Always pay attention to road and driving conditions while driving.**



**Blind-Spot Safety system may not operate properly when driving on the curved road. The system may recognize the vehicle in the same lane.**

**Always pay attention to road and driving conditions while driving.**

- Driving where the road is merging/dividing

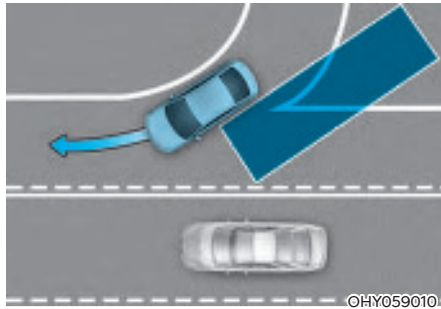

Blind-Spot Safety system may not operate properly when driving where the road merges or divides. The system may not detect the vehicle in the next lane.

Always pay attention to road and driving conditions while driving.

- Driving on a slope

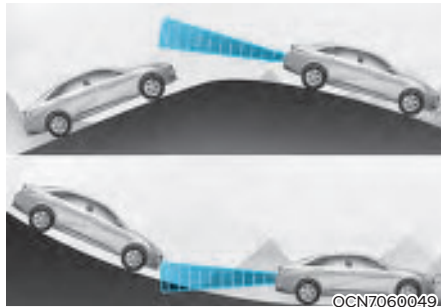

Blind-Spot Safety system may not operate properly when driving on a slope. The system may not detect the vehicle in the next lane or may incorrectly detect the ground or structure.

Always pay attention to road and driving conditions while driving.

- Driving where the heights of the lanes are different

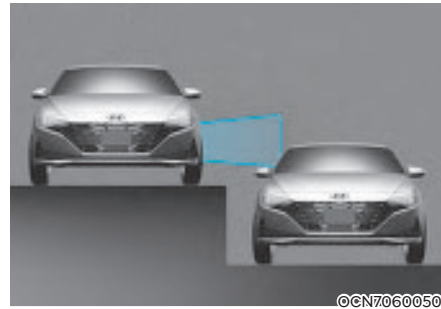

Blind-Spot Safety system may not operate properly when driving where the heights of the lanes are different. The system may not detect the vehicle on a road with different lane heights (underpass joining section, grade separated intersections, etc.).

Always pay attention to road and driving conditions while driving.

#### WARNING

- When you are towing a trailer or another vehicle, make sure that you turn off Blind-Spot Safety system.
- Blind-Spot Safety system may not operate normally if interfered by strong electromagnetic waves.
- Blind-Spot Safety system may not operate for 15 seconds after the vehicle is started, or the rear corner radars are initialized.

## BLIND-SPOT COLLISION-AVOIDANCE ASSIST (BCA) (IF EQUIPPED)

Blind-Spot Collision-Avoidance Assist is designed to help detect and monitor approaching vehicles in the driver's blind spot area and warn the driver of a possible collision with a warning message and audible warning.

In addition, if there is a risk of collision when changing lanes or driving forward out of a parking space, the system will help avoid a collision by applying the brake.

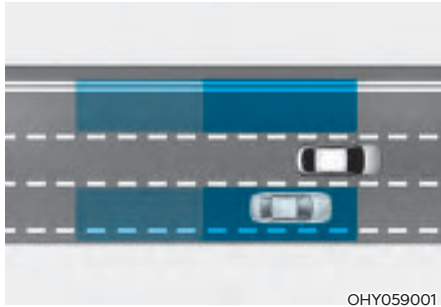

Blind-Spot Collision-Avoidance Assist helps detect and inform the driver that a vehicle is in the blind spot.

### CAUTION

The detecting range may vary depending on the speed of your vehicle. However, even if there is a vehicle in the blind spot area, the function may not warn you when you pass by at high speeds.

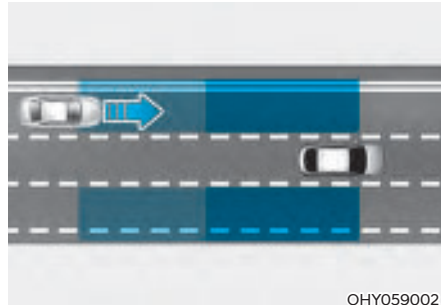

Blind-Spot Collision Assist helps detect and informs the driver that a vehicle is approaching at high speed from the blind spot area.

### CAUTION

Warning timing may vary depending on the speed of the vehicle approaching at high speed.

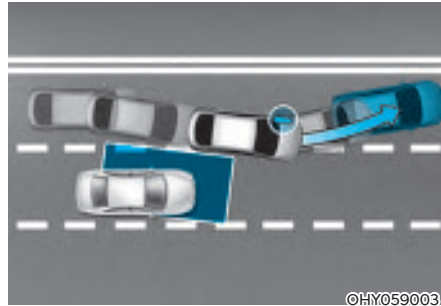

When changing lanes by detecting the lane ahead, if the system judges that there is a collision risk with an approaching vehicle in the blind spot, the function will help avoid a collision by applying the brake.

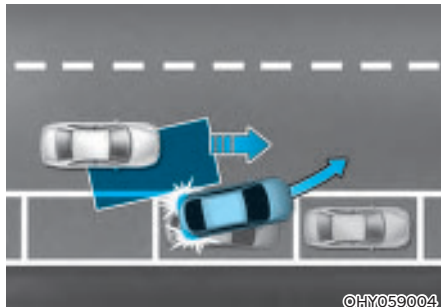

When you are driving forward out of a parking space, if the system detects that there is a collision risk with an approaching vehicle in the blind spot, the function will help avoid a collision by applying the brake.

### **i** Information

In the following text, Blind-Spot Collision-Avoidance Assist will be referred as Blind-Spot Safety system.

### **Detecting sensor**



[1] : Front view camera,  
[2] : Rear corner radar

Refer to the picture above for the detailed location of the detecting sensors.

### **⚠ CAUTION**

Take the following precautions to maintain optimal performance of the detecting sensor:

- Never disassemble the rear corner radar or radar assembly, or apply any impact on it.
- If there is impact on the rear corner radar or near the radar, even though the warning message does not appear on the cluster, Blind-Spot Safety system may not operate properly. We recommend that the system be inspected by an authorized HYUNDAI dealer.

- If the rear corner radars have been replaced or repaired, we recommend that the vehicle be inspected by an authorized HYUNDAI dealer.
- Use only genuine parts to repair the rear bumper where the rear corner radar is located.
- Do not apply license plate frame or objects, such as a bumper sticker, film or a bumper guard near the rear corner radar.
- The function may not work properly if the bumper has been replaced, or the surroundings of the rear corner radar has been damaged or paint has been applied.
- If a trailer, carrier, etc. is installed, it may adversely affect the performance of the rear corner radar or the system may not operate.

For more details on the precautions of the front view camera, refer to “Forward Collision-Avoidance Assist (FCA)” section in chapter 7.

## Function settings

### Setting



### Blind-Spot Safety

With the engine on, select ‘Driver Assistance → Blind-Spot Safety’ from the Settings menu to set whether or not to use each function.

- If ‘Active Assist’ is selected, the system will warn the driver with a warning message, an audible warning and braking assist will be applied depending on the collision risk levels.
- If ‘Warning Only’ is selected, the system will warn the driver with a warning message and an audible warning depending on the collision risk levels. Braking will not be assisted.
- If ‘Off’ is selected, the function will turn off.





When the engine is restarted with the system off, the 'Blind-Spot Safety System is Off' message will appear on the cluster.

If you change the setting from 'Off' to 'Active Assist' or 'Warning Only', the warning light on the outside rearview mirror will blink for three seconds.

In addition, if the engine is turned on, when the system is set to 'Active Assist' or 'Warning Only', the warning light on the outside rearview mirror will blink for three seconds.



#### WARNING

- If 'Warning Only' is selected, braking is not assisted.
- If 'Off' is selected, the driver should always be aware of the surroundings and drive safely.



#### Information

If the engine is restarted, Blind-Spot Safety system will maintain the last setting.

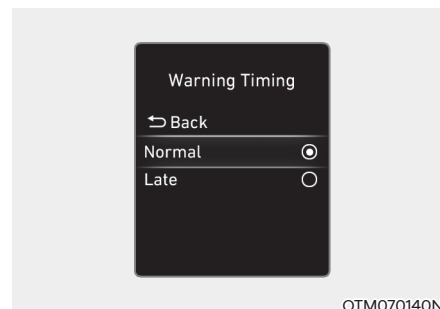

#### Warning Timing

With the engine on, select 'Driver Assistance → Warning Timing' from the Settings menu to change the initial warning activation time for Blind-Spot Safety system.

When the vehicle is first delivered, Warning Timing is set to 'Normal'. If you change the Warning Timing, the warning time of other Driver Assistance systems may change.

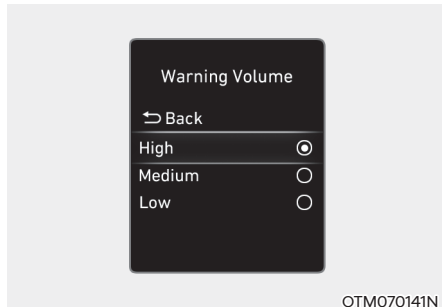

### Warning Volume

With the engine on, select 'Driver Assistance → Warning Volume' from the Settings menu to change the Warning Volume to 'High', 'Medium' or 'Low' for Blind-Spot Safety system.

If you change the Warning Volume, the warning volume of other Driver Assistance systems may change.



### CAUTION

- **The setting of the Warning Timing and Warning Volume applies to all functions of the Blind-Spot Safety system.**
- **Even though 'Normal' is selected for Warning Timing, if the vehicles approaches at high speed, the initial warning activation time may seem late.**
- **Select 'Late' for Warning Timing when traffic is light and when driving speed is slow.**

## Function operation

### Function warning and control



### Vehicle detection

- To warn the driver a vehicle is detected, the warning light on the outside rearview mirror will illuminate.
- The system will operate when your vehicle speed is above 12 mph (20 km/h) and the speed of the vehicle in the blind spot area is above 7 mph (10 km/h).

### Collision Warning

- Collision warning will operate when the turn signal is turned on in the direction of the detected vehicle.
- If 'Warning Only' is selected from the Settings menu, the collision warning will operate when your vehicle approaches the lane the blind spot vehicle is detected.
- To warn the driver of a collision, the warning light on the outside rearview mirror and head-up display (if equipped) will blink. At the same time, an audible warning will sound.
- When the turn signal is turned off or you move away from the lane, the collision warning will be canceled and the system will return to vehicle detection state.



### WARNING

- **The detecting range of the rear corner radar is determined by a standard road width, therefore, on a narrow road, the system may detect other vehicles in the next next lane and warn you. In contrast, on a wide road, the system may not be able to detect a vehicle driving in the next lane and may not warn you.**
- **When the hazard warning flasher is on, the collision warning by the turn signal will not operate.**



### Information

**If the driver's seat is on the left side, the collision warning may occur when you turn left. Maintain a proper distance with the vehicles in the left lane. If the driver's seat is on the right side, the collision warning may occur when you turn right. Maintain a proper distance with the vehicles in the right lane.**

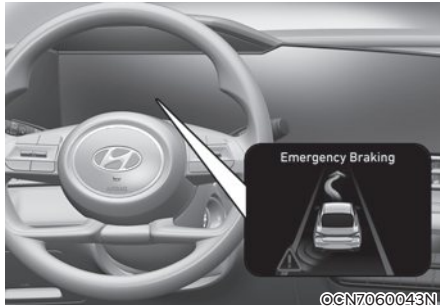

**Collision-Avoidance Assist (while driving)**

- To warn the driver of a collision, the warning light on the outside rearview mirror will blink and a warning message will appear on the cluster. At the same time, an audible warning will sound and warning light on the head-up display (if equipped) will blink.
- The function will operate when your vehicle speed is between 40~120 mph (60~200 km/h) and both lane markings of the driving lane are detected.
- Emergency braking will be assisted to help prevent collision with the vehicle in the blind spot area.

 **WARNING**

- **Collision-Avoidance Assist will be canceled under the following circumstances:**
  - Your vehicle enters the next lane by a certain distance
  - Your vehicle is away from the collision risk
  - The steering wheel is sharply steered
  - The brake pedal is depressed
  - Forward Collision-Avoidance Assist is operating
- **After function operation or lane change, you must drive to the center of the lane. The function will not operate if the vehicle is not driven in the center of the lane.**



#### Collision-Avoidance Assist (while departing)

- To warn the driver of a collision, the warning light on the outside rearview mirror will blink and a warning message will appear on the cluster. At the same time, an audible warning will sound and warning light on the head-up display (if equipped) will blink.
- The function will operate when your vehicle speed is below 2 mph (3 km/h) and the speed of the vehicle in the blind spot area is above 3 mph (5 km/h).
- Emergency braking will be assisted to help prevent collision with the vehicle in the blind spot area.



#### Stopping vehicle and ending brake control

- When the vehicle is stopped due to emergency braking, the 'Drive carefully' warning message will appear on the cluster.  
For your safety, the driver should depress the brake pedal immediately and check the surroundings.
- Brake control will end after the vehicle is stopped by emergency braking for approximately 2 seconds.



### WARNING

Take the following precautions when using Blind-Spot Safety system:

- For your safety, change the Settings after parking the vehicle at a safe location.
- If any other system's warning message is displayed or audible warning is generated, Blind-Spot Safety system's warning message may not be displayed and audible warning may not be generated.
- You may not hear the warning sound of Blind-Spot Safety system if the surrounding is noisy.
- Blind-Spot Safety system may not operate if the driver applies the brake pedal to avoid collision.
- When Blind-Spot Safety system is operating, braking control by the system will automatically cancel when the driver excessively depresses the accelerator pedal or sharply steers the vehicle.
- During Blind-Spot Safety system operation, the vehicle may stop suddenly injuring passengers and shifting loose objects. Always have the seat belt on and keep loose objects secured.
- Even if there is a problem with Blind-Spot Safety system, the vehicle's basic braking performance will operate normally.
- Blind-Spot Safety system does not operate in all situations or cannot avoid all collisions.

- Blind-Spot Safety system may warn the driver late or may not warn the driver depending on the road and driving conditions.
- Driver should maintain control of the vehicle at all times. Do not depend on Blind-Spot Safety system. Maintain a safe braking distance, and if necessary, depress the brake pedal to reduce driving speed or to stop the vehicle.
- Never operate Blind-Spot Safety system on people, animal, objects, etc. It may cause serious injury or death.



### WARNING

The brake control may not operate properly depending on the status of ESC (Electronic Stability Control).

There will only be a warning when:

- The ESC (Electronic Stability Control) warning light is on
- ESC (Electronic Stability Control) is engaged in a different function

## Function malfunction and limitations

### Function malfunction

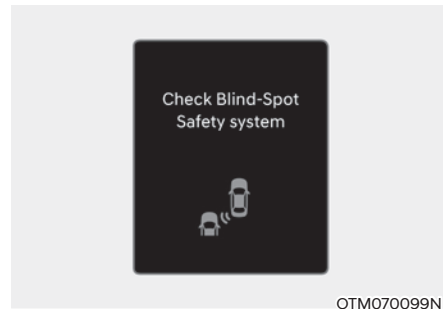

When Blind-Spot Safety system is not working properly, the 'Check Blind-Spot Safety system(s)' warning message will appear on the cluster, and the system will turn off automatically or the system will be limited. We recommend that the system be inspected by an authorized HYUNDAI dealer.

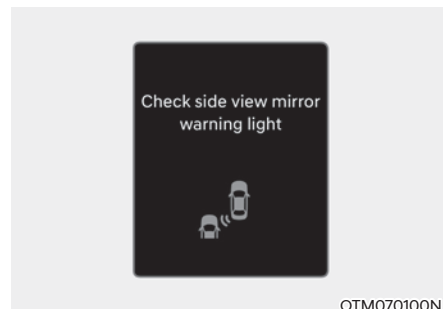

When the outside rearview mirror warning light is not working properly, the 'Check side view mirror warning light' warning message will appear on the cluster. We recommend that the system be inspected by an authorized HYUNDAI dealer.

### Function disabled

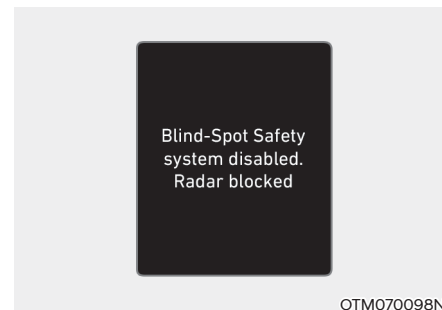

When the rear bumper around the rear corner radar or sensor is covered with foreign material, such as snow or rain, or installing a trailer or carrier, it can reduce the detecting performance and temporarily limit or disable Blind-Spot Safety system.

If this occurs, the 'Blind-Spot Safety system(s) disabled. Radar blocked' warning message will appear on the cluster.

The function will operate normally when such foreign material or trailer, etc. is removed, and then the engine is restarted.

If the function does not operate normally after it is removed, we recommend that the system be inspected by an authorized HYUNDAI dealer.

### WARNING

- **Even though the warning message does not appear on the cluster, Blind-Spot Safety system may not properly operate.**
- **Blind-Spot Safety system may not properly operate in an area (e.g. open terrain) where any substance are not detected right after the engine is turned on, or when the detecting sensor is blocked with foreign material right after the engine is turned on.**



### CAUTION

**Turn off Blind-Spot Safety system to install a trailer, carrier, etc., or remove the trailer, carrier, etc. to use Blind-Spot Safety system.**

#### ***Limitations of the system***

Blind-Spot Safety system may not operate normally, or the system may operate unexpectedly under the following circumstances:

- There is inclement weather, such as heavy snow, heavy rain, etc.
- The rear corner radar is covered with snow, rain, dirt, etc.
- The temperature around the rear corner radar is high or low
- Driving on a highway (or motorway) ramp
- The road pavement (or the peripheral ground) abnormally contains metallic components (i.e. possibly due to subway construction)
- There is a fixed object near the vehicle, such as sound barriers, guardrails, central dividers, entry barriers, street lamps, signs, tunnels, walls, etc. (including double structures)
- Driving in large areas where there are few vehicles or structures (i.e. desert, meadow, suburb, etc.)
- Driving through a narrow road where trees or grass are overgrown
- Driving on a wet road surface, such as a puddle on the road
- The other vehicle drives very close behind your vehicle, or the other vehicle passes by your vehicle in close proximity

- The speed of the other vehicle is very fast that it passes by your vehicle in a short time
- Your vehicle passes by the other vehicle
- Your vehicle changes lane
- Your vehicle has started at the same time as the vehicle next to you and has accelerated
- The vehicle in the next lane moves two lanes away from you, or when the vehicle two lanes away moves to the next lane from you
- A trailer or carrier is installed around the rear corner radar
- The bumper around the rear corner radar is covered with objects, such as a bumper sticker, bumper guard, bike rack, etc.
- The bumper around the rear corner radar is impacted, damaged or the radar is out of position
- Your vehicle height is low or high due to heavy loads, abnormal tire pressure, etc.

Blind-Spot Safety system may not operate normally, or the system may operate unexpectedly when the following objects are detected:

- A motorcycle or bicycle is detected
- A vehicle such as a flat trailer is detected
- A big vehicle such as a bus or truck is detected
- A moving obstacle such as a pedestrian, animal, shopping cart or a baby stroller is detected
- A vehicle with low height such as a sports car is detected



Braking control may not work, driver's attention is required in the following circumstances:

- The vehicle severely vibrates while driving over a bumpy road, uneven road or concrete patch
- Driving on a slippery surface due to snow, water puddle, ice, etc.
- The tire pressure is low or a tire is damaged
- The brake is reworked
- The vehicle makes abrupt lane changes

**For more details on the limitations of the front view camera, refer to "Forward Collision-Avoidance Assist (FCA)" and "Lane Keeping Assist (LKA)" section in chapter 7.**

 **WARNING**

- **Driving on a curve**



**Blind-Spot Safety system may not operate properly when driving on a curved road. The system may not detect the vehicle in the next lane.**

**Always pay attention to road and driving conditions while driving.**



**Blind-Spot Safety system may not operate properly when driving on a curved road. The system may recognize a vehicle in the same lane.**

**Always pay attention to road and driving conditions while driving.**

- Driving where the road is merging/dividing

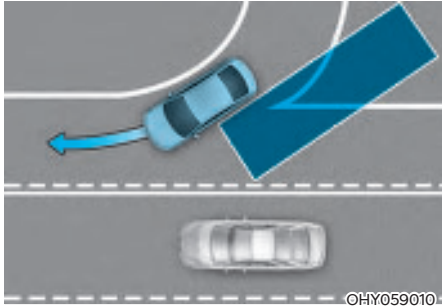

Blind-Spot Safety system may not operate properly when driving where the road merges or divides. The system may not detect the vehicle in the next lane.

Always pay attention to road and driving conditions while driving.

- Driving on a slope

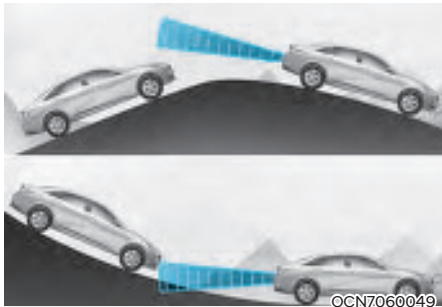

Blind-Spot Safety system may not operate properly when driving on a slope. The system may not detect the vehicle in the next lane or may incorrectly detect the ground or structure.

Always pay attention to road and driving conditions while driving.

- Driving where the heights of the lanes are different

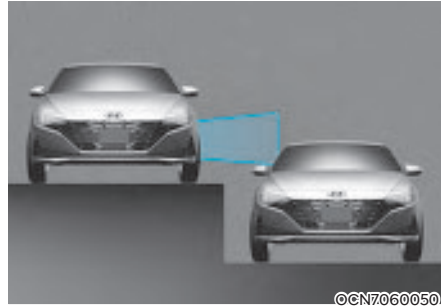

Blind-Spot Safety system may not operate properly when driving where the heights of the lanes are different. The system may not detect the vehicle on a road with different lane heights (underpass joining section, grade separated intersections, etc.).

Always pay attention to road and driving conditions while driving.

 **WARNING**

- When you are towing a trailer or another vehicle, make sure that you turn off Blind-Spot Safety system.
- Blind-Spot Safety system may not operate normally if interfered by strong electromagnetic waves.
- Blind-Spot Safety system may not operate for 15 seconds after the vehicle is started, or the front view camera or rear corner radars are initialized.

***i* Information**

This device complies with Part 15 of the FCC rules.

Operation is subject to the following three conditions:

1. This device may not cause harmful interference, and
2. This device must accept any interference received, including interference that may cause undesired operation.
3. Changes or modifications not expressly approved by the party responsible for compliance could void the user's authority to operate the device.

***i* Information**

Radio frequency radiation exposure information:

This equipment complies with FCC radiation exposure limits set forth for an uncontrolled environment.

This equipment should be installed and operated with minimum distance of 8 in. (20 cm) between the radiator (antenna) and your body.

This transmitter must not be co-located or operating in conjunction with any other antenna or transmitter.

## SAFE EXIT WARNING (SEW) (IF EQUIPPED)

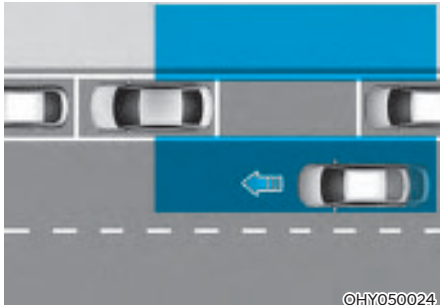

After the vehicle stops, when an approaching vehicle from the rear area is detected as soon as a passenger opens a door, Safe Exit Warning will warn the driver with a warning message and an audible warning to help prevent a collision.



### CAUTION

Warning timing may vary depending on the speed of the approaching vehicle.

### Detecting sensor



The rear corner radars are sensors located inside the rear bumper to help detect the side and rear areas. Always keep the rear bumper clean for proper operation of Safe Exit Warning.

### NOTICE

For more details on the precautions of the rear corner radars, refer to “Blind-Spot Collision Warning (BCW)” or “Blind-Spot Collision-Avoidance Assist (BCA)” section in chapter 7.

## Function settings

### Setting



#### Safe Exit Warning

With the engine on, select 'Driver Assistance → Blind-Spot Safety → Safe Exit Warning (SEW)' from the Settings menu to turn on Safe Exit Warning and deselect to turn off the function.



#### **WARNING**

The driver should always be aware of unexpected and sudden situations from occurring. If 'Safe Exit Warning' is deselected, the function cannot assist you.



#### **Information**

If the engine is restarted, Safe Exit Warning will maintain the last setting.

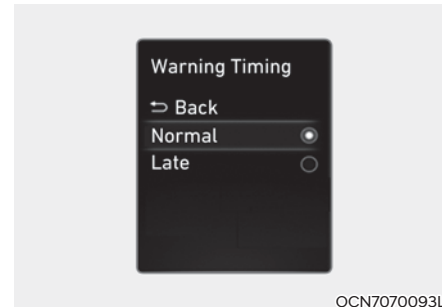

#### Warning Timing

With the engine on, select 'Driver Assistance → Warning Timing' from the Settings menu to change the initial warning activation time for Blind-Spot Safety system.

When the vehicle is first delivered, Warning Timing is set to 'Normal'. If you change the Warning Timing, the warning time of other Driver Assistance systems may change.



### Warning Volume

With the engine on, select 'Driver Assistance → Warning Volume' from the Settings menu to change the Warning Volume to 'High', 'Medium', or 'Low' for Blind-Spot Safety system.

If you change the warning volume, the Warning Volume of other Driver Assistance systems may change.



### CAUTION

- The setting of the Warning Timing and Warning Volume applies to all functions of the Safe Exit Warning.
- Even though 'Normal' is selected for Warning Timing, if the vehicle approaches at high speed from the rear, the initial warning activation time may seem late.
- Select 'Late' for Warning Timing when traffic is light and when driving speed is slow.



### Information

If the engine is restarted, Warning Timing and Warning Volume will maintain the last setting.

## Function operation

### Warning and control

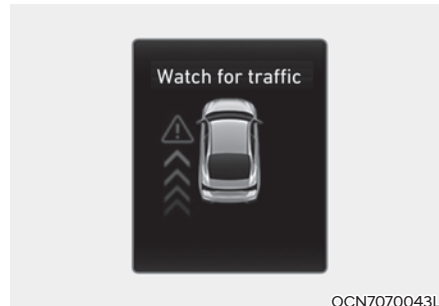

### Collision warning when exiting vehicle

- When an approaching vehicle from the rear is detected, the 'Watch for traffic' warning message will appear on the cluster, and an audible warning will sound.
- Safe Exit Warning will warn the driver when your vehicle speed is below 2 mph (3 km/h), and the speed of the approaching vehicle from the rear is above 3 mph (5 km/h).



## WARNING

Take the following precautions when using Safe Exit Warning:

- For your safety, change the Settings after parking the vehicle at a safe location.
- If any other function's warning message is displayed or audible warning is generated, Safe Exit Warning warning message may not be displayed and audible warning may not be generated.
- You may not hear the warning sound of Safe Exit Warning if the surrounding is noisy.
- Safe Exit Warning does not operate in all situations or cannot prevent all collisions.
- Safe Exit Warning may warn the driver late or may not warn the driver depending on the road and driving conditions. Always check vehicle surroundings.
- The driver and passengers are responsible for accidents that occurs while exiting the vehicle. Always check the surroundings before you exit the vehicle.
- Never deliberately operate Safe Exit Warning. Doing so may lead to serious injury or death.
- Safe Exit Warning does not operate if there is a problem with Blind-Spot Safety system. The warning message of Blind-Spot Safety system will appear when:
  - Blind-Spot Safety system sensor or the sensor surrounding is polluted or covered
  - Blind-Spot Safety system fails to warn passengers or falsely warn passengers



## Information

After the engine is turned off, Safe Exit Warning operates approximately for 10 minutes, but turns off immediately if the doors are locked.

### Function malfunction and limitations

#### Function malfunction

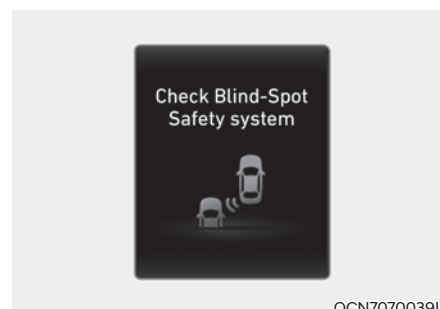

OCN7070039L

When Safe Exit Warning is not working properly, the 'Check Blind-Spot Safety system' warning message will appear on the cluster, and the system will turn off automatically or the system will be limited. We recommend that the system be inspected by an authorized HYUNDAI dealer.

### Function disabled

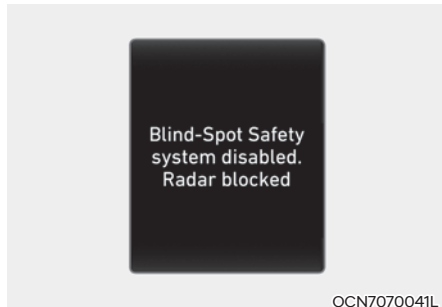

When the rear bumper around the rear corner radar or sensor is covered with foreign material, such as snow or rain, or installing a trailer or carrier, it can reduce the detecting performance and temporarily limit or disable Safe Exit Warning.

If this occurs, the 'Blind-Spot Safety function disabled. Radar blocked' warning message will appear on the cluster.

The function will operate normally when such foreign material or trailer, etc. is removed, and then the engine is restarted.

If the function does not operate normally after it is removed, we recommend that the system be inspected by an authorized HYUNDAI dealer.

### WARNING

- Even though the warning message does not appear on the cluster, Safe Exit Warning may not properly operate.
- Safe Exit Warning may not properly operate in an area (e.g. open terrain) where any substance are not detected right after the engine is turned on, or when the detecting sensor is blocked with foreign material right after the engine is turned on.

### CAUTION

Turn off Safe Exit Warning to install a trailer, carrier, etc., or remove the trailer, carrier, etc. to use Safe Exit Warning.

### Limitations of the function

Safe Exit Warning may not operate normally, or the function may operate unexpectedly under the following circumstances:

- Getting off the vehicle where trees or grass are overgrown
- Getting off the vehicle where the road is wet
- The approaching vehicle is very fast or very slow

### WARNING

- Safe Exit Warning may not operate normally if interfered by strong electromagnetic waves.
- Safe Exit Warning may not operate for 3 seconds after the vehicle is started, or rear corner radars are initialized.



## MANUAL SPEED LIMIT ASSIST (MSLA) (IF EQUIPPED)

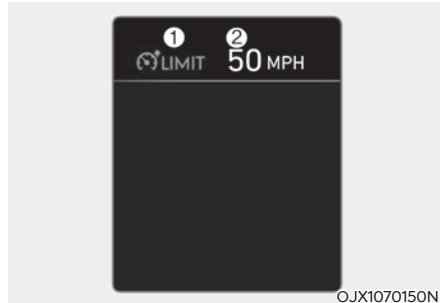

(1) Manual Speed Limit Assist enabled indicator

(2) Set speed

You can set the speed limit when you do not want to drive over a specific speed.

If you drive over the preset speed limit, Manual Speed Limit Assist will operate (set speed limit will blink and chime will sound) until the vehicle speed returns within the speed limit.

### System operation

#### To set speed limit

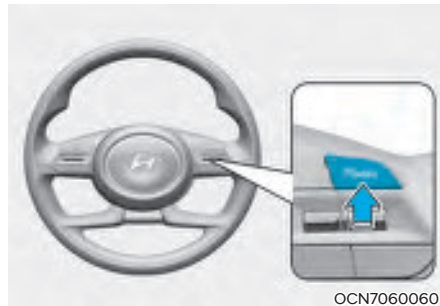

1. Press and hold Driving Assist (MODE) button at the desired speed. The Manual Speed Limit Assist enabled (LIMIT) indicator will illuminate on the cluster.



2. Push the + switch up or - switch down, and release it at the desired speed.

Push the + switch up or - switch down and hold it. The speed will increase or decrease to the nearest multiple of ten (multiple of five in mph) at first, and then increase or decrease by 10 km/h (5 mph).

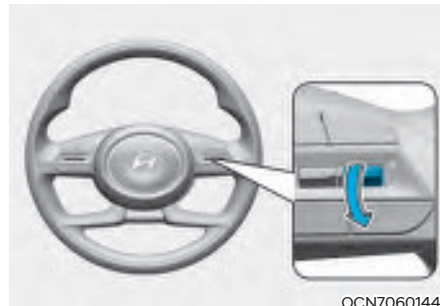

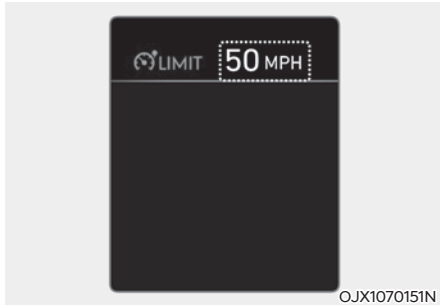

3. The set speed limit will be displayed on the cluster.

If you would like to drive over the preset speed limit, depress the accelerator pedal beyond the pressure point to activate the kickdown mechanism.

The set speed limit will blink and chime will sound until you return the vehicle speed within the speed limit.

### **i** Information

- **When the accelerator pedal is not depressed beyond the pressure point, vehicle speed will maintain within the speed limit.**
- **A clicking sound may be heard from the kickdown mechanism when the accelerator pedal is depressed beyond the pressure point.**

### **To temporarily pause the system**

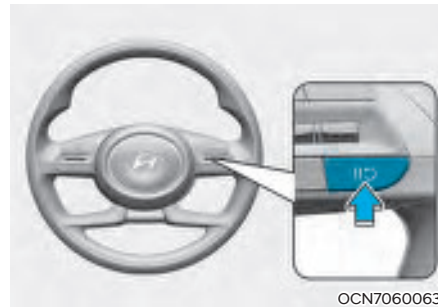

[A] : Type A, [B] : Type B

Push the **LIMIT** switch to temporarily pause the set speed limit. The set speed limit will turn off but the Manual Speed Limit Assist enabled (**LIMIT**) indicator will stay on.

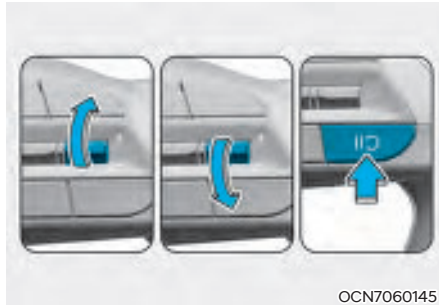
**To resume the system**

OCN7060145

To resume Manual Speed Limit Assist after the system was paused, push the +, -, II switch.

If you push the + switch up or - switch down, vehicle speed will be set to the current speed on the cluster.

If you push the II switch, vehicle speed will resume to the preset speed.

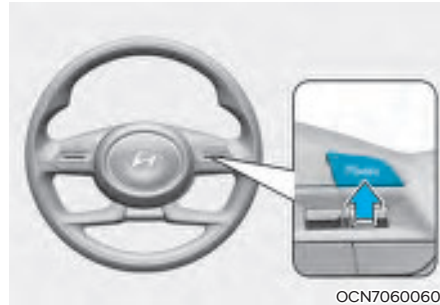
**To turn off the system**

OCN7060060

Press the Driving Assist (MODE) button to turn Manual Speed Limit Assist off. The Manual Speed Limit Assist enabled (LIMIT) indicator will go off.

Always press the Driving Assist (MODE) button to turn Manual Speed Limit Assist off when not in use.

**⚠ WARNING**

Take the following precautions when using Manual Speed Limit Assist:

- Always set the vehicle speed to the speed limit in your country.
- Keep Manual Speed Limit Assist off when the system is not in use, to avoid inadvertently setting a speed. Check that the Manual Speed Limit Assist enabled (LIMIT) indicator is off.
- Manual Speed Limit Assist does not substitute for proper and safe driving. It is the responsibility of the driver to always drive safely and should always be aware of unexpected and sudden situations from occurring. Pay attention to the road conditions at all times.

## DRIVER ATTENTION WARNING (DAW) (IF EQUIPPED)

### Basic function

Driver Attention Warning can help determine the driver's attention level by analyzing driving pattern, driving time, etc. while vehicle is being driven. The system can recommend a break when the driver's attention level falls below a certain level.

### Leading Vehicle Departure Alert function

Leading Vehicle Departure Alert function can inform the driver when the front vehicle departs from a stop.

### Detecting sensor



[1] : Front view camera

The front view camera is used to help detect driving patterns and front vehicle departure while vehicle is being driven.

Refer to the picture above for the detailed location of the detecting sensor.



### CAUTION

**Always keep the front view camera in good condition to maintain optimal performance of Driver Attention Warning.**

**For more details on the precautions of the front view camera, refer to "Forward Collision-Avoidance Assist (FCA)" section in chapter 7.**

### Function settings

#### Setting

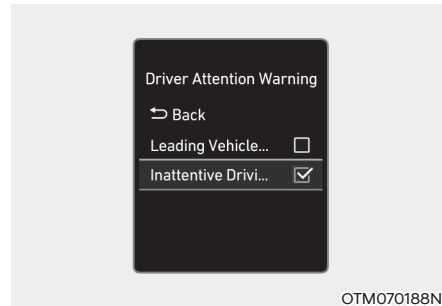

#### Driver Attention Warning

With the engine on, select 'Driver Assistance → Driver Attention Warning' from the Settings menu to set whether or not to use each function.

- If 'Inattentive Driving Warning' is selected, the system can inform the driver the driver's attention level and can recommend taking a break when the level falls below a certain level.

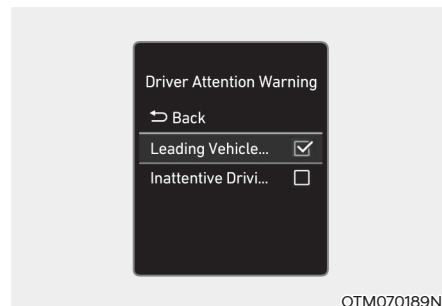

#### Leading Vehicle Departure Alert

- If 'Leading Vehicle Departure Alert' is selected, the function can inform the driver when the front vehicle departs from a stop.



### Warning Timing

With the engine on, select 'Driver Assistance → Warning Timing' from the Settings menu to change the initial warning activation time for Driver Attention Warning.

When the vehicle is first delivered, Warning Timing is set to 'Normal'. If you change the Warning Timing, the warning time of other Driver Assistance systems may change.

### **i** Information

If the engine is restarted, Driver Attention Warning will maintain the last setting.

## System operation

### Basic function

#### System display and warning

The basic function of Driver Attention Warning is to inform the driver of their 'Attention Level' and to warn the driver to 'Consider taking a break'.

#### Attention level



- The driver can monitor his/her driving conditions on the cluster.
  - When the 'Inattentive Driving Warning' is deselected from the Settings menu, 'System Off' is displayed.
  - The function will operate when vehicle speed is between 0-110 mph (0-180 km/h).
  - When vehicle speed is not within the operating speed, the message 'Standby' will be displayed.

- The driver's attention level is displayed on the scale of 1 to 5. The lower the level is, the more inattentive the driver is.
- The level decreases when the driver does not take a break for a certain period of time.

### Taking a break

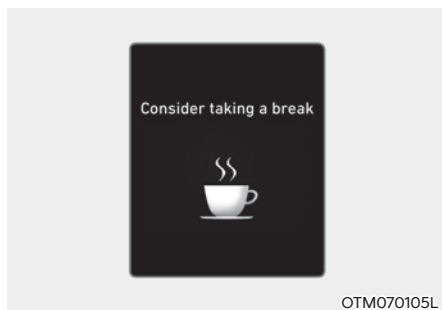

- The 'Consider taking a break' message will appear on the cluster and an audible warning will sound to suggest that the driver take a break, when the driver's attention level is below 1.
- Driver Attention Warning will not suggest a break when the total driving time is shorter than 10 minutes or 10 minutes has not passed after the last break was suggested.

### **WARNING**

**For your safety, change the Settings after parking the vehicle at a safe location.**

### **CAUTION**

- **Driver Attention Warning may suggest a break depending on the driver's driving pattern or habits, even if the driver doesn't feel fatigued.**
- **Driver Attention Warning is a supplemental system and may not be able to determine whether the driver is inattentive.**
- **The driver who feels fatigued should take a break at a safe location, even though there is no break suggestion by Driver Attention Warning.**

### **Information**

- **For more details on setting the functions in the infotainment system, refer to "Vehicle Settings" section in chapter 4.**
- **Driver Attention Warning will reset the last break time to 00:00 in the following situations:**
  - **The engine is turned off**
  - **The driver unfastens the seat belt and opens the driver's door**
  - **The vehicle is stopped for more than 10 minutes**
- **When the driver resets Driver Attention Warning, the last break time is set to 00:00 and the driver's attention level is set to High.**

### Leading Vehicle Departure Alert function



When a detected front vehicle departs from a stop, Leading Vehicle Departure Alert will inform the driver by displaying the 'Leading vehicle is driving away' message on the cluster and an audible warning will sound.

#### WARNING

- If any other system's warning message is displayed or audible warning is generated, Leading Vehicle Departure Alert's warning message may not be displayed and audible warning may not be generated.
- The driver should hold the responsibility to safely drive and control the vehicle.

#### CAUTION

- Leading Vehicle Departure Alert is a supplemental function and may not alert the driver whenever the front vehicle departs from a stop.
- Always check the front of the vehicle and road conditions before departure.

### Function malfunction and limitations

#### Function malfunction

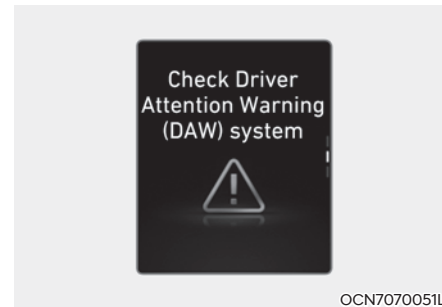

When Driver Attention Warning is not working properly, the 'Check Driver Attention Warning (DAW) system' warning message will appear on the cluster. If this occurs, we recommend that the system be inspected by an authorized HYUNDAI dealer.

#### Limitations of the system

Driver Attention Warning may not work properly in the following situations:

- The vehicle is driven violently
- The vehicle intentionally crosses over lanes frequently
- The vehicle is controlled by Driver Assistance system, such as Lane Keeping Assist

**Leading Vehicle Departure Alert feature**

- When the vehicle cuts in

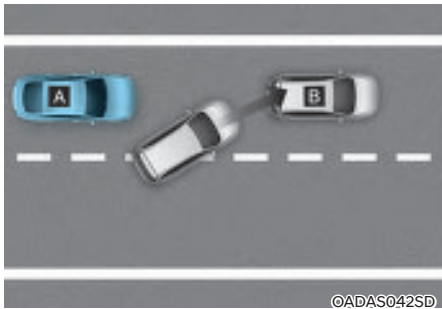
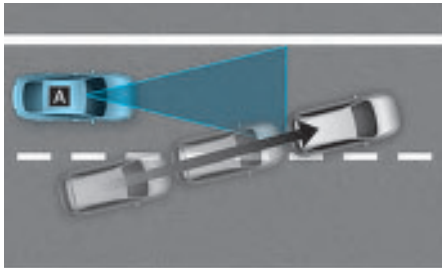

[A] : Your vehicle, [B] : Front vehicle

If a vehicle cuts in front of your vehicle, Leading Departure Alert may not operate properly.

- When the vehicle ahead sharply steers

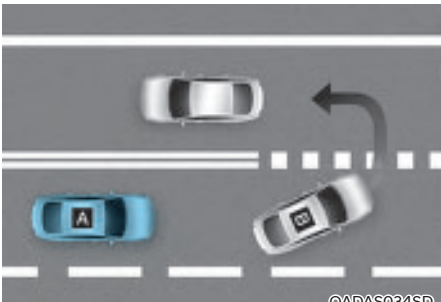

[A] : Your vehicle, [B] : Front vehicle

If the vehicle in front makes a sharp turn, such as to turn left or right or make a U-turn, etc., Leading Vehicle Departure Alert may not operate properly.

- When the vehicle ahead abruptly departs

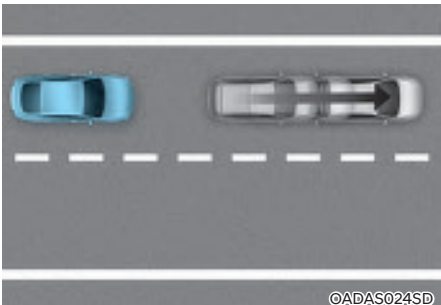

If the vehicle in front abruptly departs, Leading Vehicle Departure Alert may not operate properly.



- When a pedestrian or bicycle is between you and the vehicle ahead

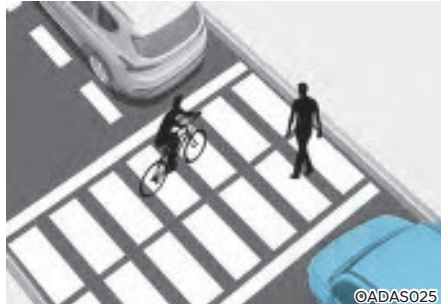

If there is a pedestrian(s) or bicycle(s) in between you and the vehicle in front, Leading Vehicle Departure Alert may not operate properly.

- When in a parking lot

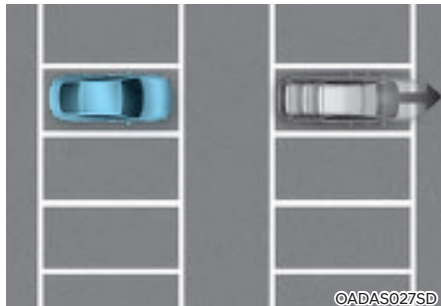

If a vehicle parked in front drives away from you, Leading Vehicle Departure Alert may alert you that the parked vehicle is driving away.

- When driving at a tollgate or intersection, etc.

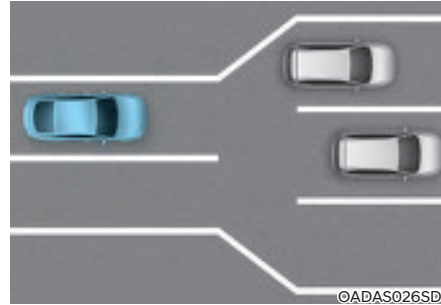

If you pass a tollgate or intersection with lots of vehicles or you drive where lanes are merged or divided frequently, Leading Vehicle Departure Alert may not operate properly.

#### CAUTION

For more details on the precautions of the front view camera, refer to “Forward Collision-Avoidance Assist (FCA)” section in chapter 7.

## CRUISE CONTROL (CC) (IF EQUIPPED)

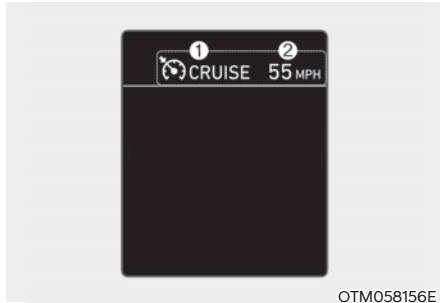

- (1) Cruise indicator
- (2) Set speed

Cruise Control will allow you to drive at speeds above 20 mph (30 km/h) without depressing the accelerator pedal.

### Function operation

#### To set speed

1. Accelerate to the desired speed, which must be more than 20 mph (30 km/h).

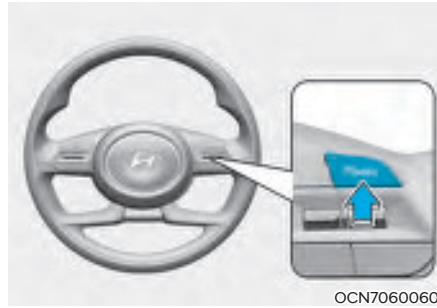

2. Press the Driving Assist button at the desired speed. The set speed and Cruise (CRUISE) indicator will illuminate on the cluster.
3. Release the accelerator pedal. Vehicle speed will maintain the set speed even when the accelerator pedal is not depressed.

### **i** Information

**On a steep slope, the vehicle may slightly slow down or speed up while driving uphill or downhill.**

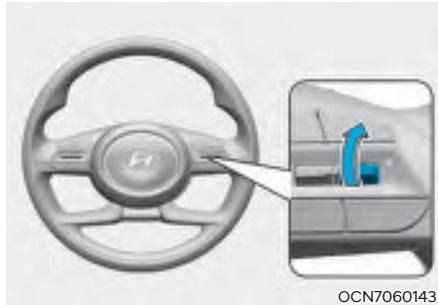
**To increase speed**

- Push the + switch up and release it immediately. The cruising speed will increase by 1 mph (1 km/h) each time the switch is operated in this manner.
- Push the + switch up and hold it while monitoring the set speed on the cluster. The cruising speed will increase to the nearest multiple of ten (multiple of five in mph) at first, and then increase by 5 mph (10 km/h) each time the switch is operated in this manner.

Release the switch when the desired speed is shown and the vehicle will accelerate to that speed.

**To decrease speed**

- Push the - switch down and release it immediately. The cruising speed will decrease by 1 mph (1 km/h) each time the switch is operated in this manner.
- Push the - switch down and hold it while monitoring the set speed on the cluster. The cruising speed will decrease to the nearest multiple of ten (multiple of five in mph) at first, and then decrease by 5 mph (10 km/h) each time the switch is operated in this manner.

Release the switch at the speed you want to maintain.

**To temporarily pause the function**

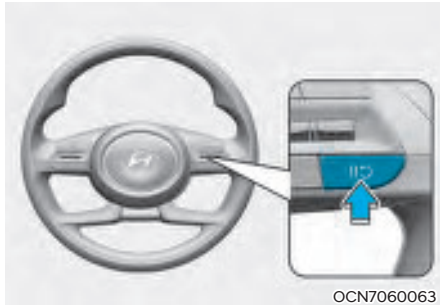

Cruise Control will be paused when:

- Depressing the brake pedal.
- Pushing the **||** button.
- Shifting the gear to N (Neutral).
- Decreasing vehicle speed to less than approximately 20 mph (30 km/h).
- ESC (Electronic Stability Control) is operating.
- Downshifting to 2nd gear when in Manual Shift mode.

The set speed will turn off but the Cruise (**||** CRUISE) indicator will stay on.

**To resume the function**

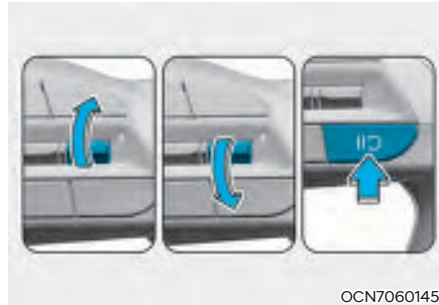

Push the +, - switch or **||** button.

If you push the + switch up or - switch down, vehicle speed will be set to the current speed on the cluster.

If you push the **||** button, vehicle speed will resume to the preset speed. Vehicle speed must be above 20 mph (30 km/h) for the function to resume.

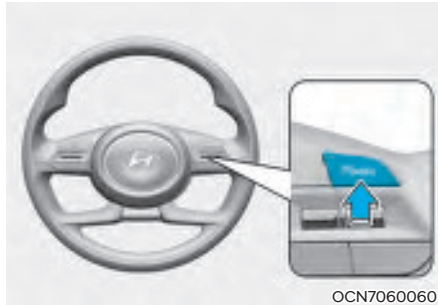
**To turn off the function**

Press the Driving Assist button to turn Cruise Control off. The Cruise (CRUISE) indicator will go off.

Always press the Driving Assist button to turn Cruise Control off when not in use.

**i Information**

If your vehicle is equipped with Manual Speed Limit Assist, press and hold the Driving Assist button to turn off Cruise Control. However, Manual Speed Limit Assist will turn on.

**⚠ WARNING**

Take the following precautions when using Cruise Control:

- Always set the vehicle speed to the speed limit in your region.
- Keep Cruise Control off when the system is not in use, to avoid inadvertently setting a speed. Check that the Cruise (CRUISE) indicator is off.
- Cruise Control does not substitute for proper and safe driving. It is the responsibility of the driver to always drive safely and should always be aware of unexpected and sudden situations from occurring.
- Always drive cautiously to prevent unexpected and sudden situations from occurring. Pay attention to the road conditions at all times.
- Do not use Cruise Control when it may be unsafe to keep the vehicle at a constant speed:
  - When driving in heavy traffic, or when traffic conditions make it difficult to drive at a constant speed
  - When driving on rainy, icy, or snow-covered roads
  - When driving on hilly or windy roads
  - When driving in windy areas
  - When driving with limited view (possibly due to bad weather, such as fog, snow, rain and sandstorm)
  - When gear state is N (Neutral) for manual transmission.
- Do not shift the gear to N (Neutral) while the cruise control is activating without clutch pedal depressed.

## SMART CRUISE CONTROL (SCC) (IF EQUIPPED)

Smart Cruise Control is designed to detect the vehicle ahead and help maintain the desired speed and minimum distance between the vehicle ahead.

### Overtaking Acceleration Assist

While Smart Cruise Control is operating, if the system judges that the driver is determined to overtake the vehicle in front, acceleration will be assisted.

### Detecting sensor



[1] : Front view camera,

[2] : Front radar

The front view camera and front radar are used as a detecting sensor to help detect the vehicles in front.

Refer to the picture above for the detailed location of the detecting sensor.



### CAUTION

**Always keep the front view camera and front radar in good and clean condition to maintain optimal performance of Smart Cruise Control.**

**For more details on the precautions of the front view camera and front radar, refer to “Forward Collision-Avoidance Assist (FCA)” section in chapter 7.**

## Function settings

### Setting

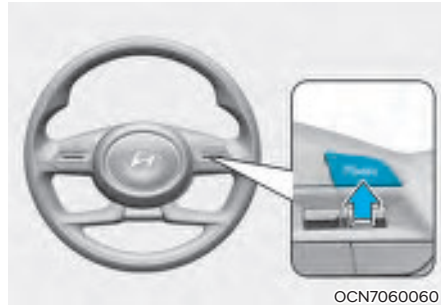

[A] : Type A, [B] : Type B

#### To turn on the function

- Press the Driving Assist button to turn on the system. The speed will be set to the current speed on the cluster.
- If there is no vehicle in front of you, the set speed will be maintained, but if there is a vehicle in front of you, the speed may decrease to maintain the distance to the vehicle ahead. If the vehicle ahead accelerates, your vehicle will travel at a steady cruising speed after accelerating to the set speed.

#### **i** Information

- If your vehicle speed is between 0~20 mph (0~30 km/h) when you press the Driving Assist button, the Smart Cruise Control speed will be set to 20 mph (30 km/h).
- The Driving Assist button symbol (MODE) may vary depending on your vehicle option.

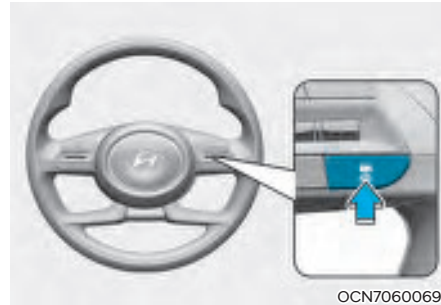

[A] : Type A, [B] : Type B

#### To set vehicle distance

Each time the button is pressed, the vehicle distance changes as follows:

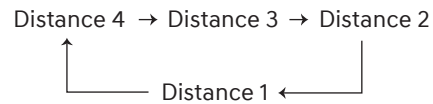

#### **i** Information

- If you drive at 56 mph (90 km/h), the distance is maintained as follows:
  - Distance 4 - approximately 172 ft. (53 m)
  - Distance 3 - approximately 130 ft. (40 m)
  - Distance 2 - approximately 106 ft. (30 m)
  - Distance 1 - approximately 82 ft. (25 m)
- The distance is set to the last set distance when the engine is restarted, or when the system was temporarily canceled.

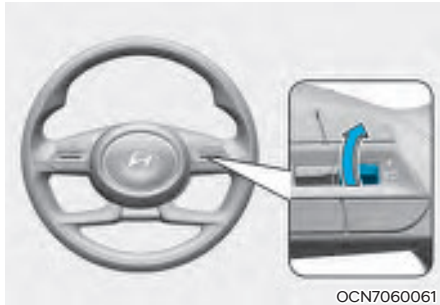

**To increase speed**

- Push the + switch up and release it immediately. The cruising speed will increase by 1 mph (1 km/h) each time the switch is operated in this manner.
- Push the + switch up and hold it while monitoring the set speed on the cluster. The cruising speed will increase by 5 mph or 10 km/h each time the switch is operated in this manner. Release the switch when the desired speed is shown, and the vehicle will accelerate to that speed. You can set the speed to 122 mph (180 km/h).



**To decrease speed**

- Push the - switch down and release it immediately. The cruising speed will decrease by 1 mph (1 km/h) each time the switch is operated in this manner.
- Push the - switch down and hold it while monitoring the set speed on the cluster. The cruising speed will decrease by 5 mph or 10 km/h each time the switch is operated in this manner. Release the switch at the speed you want to maintain. You can set the speed to 20 mph (30 km/h).

 **WARNING**

**Check the driving condition before using the + switch. Driving speed may sharply increase when you push up and hold the + switch.**



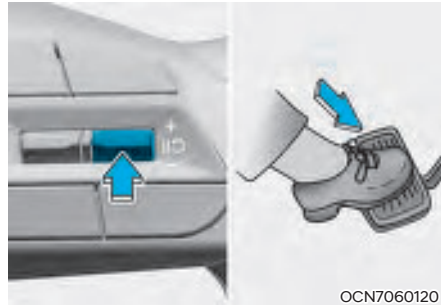

[A] : Type A, [B] : Type B

#### To temporarily cancel the function

Press the  switch or depress the brake pedal to temporarily cancel Smart Cruise Control.

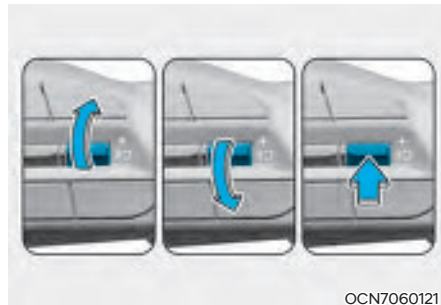

[A] : Type A, [B] : Type B



#### To resume the function

To resume Smart Cruise Control after the system was canceled, push the +, - or  switch.

If you push the + switch up or - switch down, vehicle speed will be set to the current speed on the cluster.

If you push the  switch, vehicle speed will resume to the preset speed.

#### WARNING

Check the driving condition before using the  switch. Driving speed may sharply increase or decrease when you press the  switch.

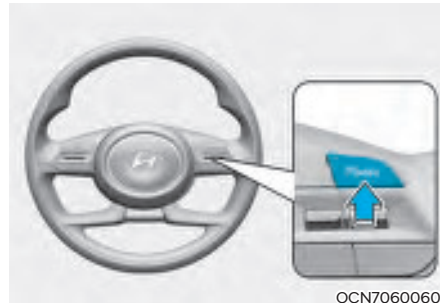

[A] : Type A, [B] : Type B

#### To turn off the function

Press the Driving Assist button to turn Smart Cruise Control system off.

#### Information

If your vehicle is equipped with Manual Speed Limit Assist, press and hold the Driving Assist button to turn off Smart Cruise Control. However, Manual Speed Limit Assist will turn on.

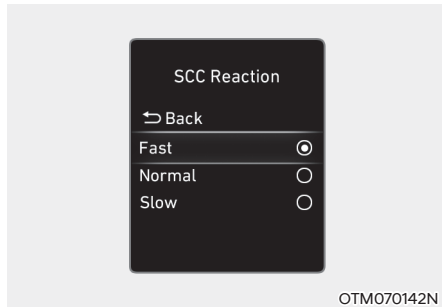

### Smart Cruise Reaction

With the engine on, select 'Driver Assistance → SCC Reaction' from the settings menu to select the sensitivity of vehicle speed when following the front vehicle to maintain the set distance.

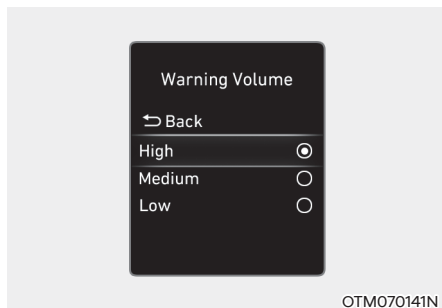

### Warning Volume

With the engine on, select 'Driver Assistance → Warning Volume' from the Settings menu to change the Warning Volume 'High', 'Medium' or 'Low' for Smart Cruise Control.

If you change the Warning Volume, the Warning Volume of other Driver Assistance systems may change.

### **i** Information

**If the engine is restarted, Warning Volume will maintain the last setting.**

## Function operation

### **Operating conditions**

Smart Cruise Control will operate when the following conditions are satisfied.

### **Basic function**

- The gear is in D (Drive)
- The driver's door is closed
- EPB (Electronic Parking Brake) is not applied
- Your vehicle speed is within the operating speed range
  - 5~110 mph (10~180 km/h): when there is no vehicle in front
  - 0~110 mph (0~180 km/h): when there is a vehicle in front
- ESC (Electronic Stability Control), TCS (Traction Control System) or ABS is on
- ESC (Electronic Stability Control), TCS (Traction Control System) or ABS is not controlling the vehicle
- Engine rpm is not in the red zone
- Forward Collision-Avoidance Assist brake control is not operating

### **i** Information

**At a stop, if there is no vehicle in front of your vehicle, the system will turn on when the brake pedal is depressed.**

### Overtaking Acceleration Assist

Overtaking Acceleration Assist will operate when the turn signal indicator is turned on to the left while Smart Cruise Control is operating, and the following conditions are satisfied:

- Your vehicle speed is above 40 mph (60 km/h)
- The hazard warning flasher is off
- A vehicle is detected in front of your vehicle
- Deceleration is not needed to maintain distance with the vehicle in front



### WARNING

- **When the turn signal indicator is turned on to the left (left-hand drive) or turned on to the right (right-hand drive) while there is a vehicle ahead, the vehicle may accelerate temporarily. Pay attention to the road conditions at all times.**
- **Regardless of your country's driving direction, Overtaking Acceleration Assist will operate when the conditions are satisfied. When using the function in countries with different driving direction, always check the road conditions at all times.**

### Function display and control

#### Basic function

You can see the status of the Smart Cruise Control operation in the Driving Assist mode on the cluster. Refer to "LCD Display Modes" section in chapter 4.

Smart Cruise Control will be displayed as below depending on the status of the system.



- When operating
  - (1) Whether there is a vehicle ahead and the selected distance level are displayed.
  - (2) Set speed is displayed.
  - (3) Whether there is a vehicle ahead and the target vehicle distance are displayed.

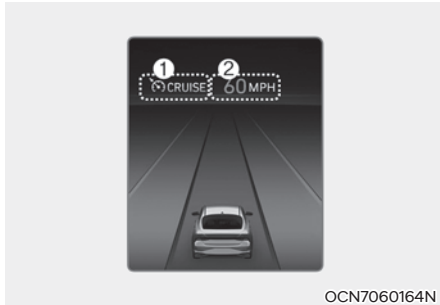

- When temporarily canceled  
(1) CRUISE indicator is displayed.  
(2) The previous set speed is shaded.

**i** Information

- The distance of the front vehicle on the cluster is displayed according to the actual distance between your vehicle and the vehicle ahead.
- The target distance may vary according to the vehicle speed and the set distance level. If vehicle speed is low, even though the vehicle distance have changed, the change of the target vehicle distance may be small.

**To temporarily accelerate**



If you want to speed up temporarily when Smart Cruise Control is on, depress the accelerator pedal. While the speed is increasing, the set speed, distance level and target distance will blink on the cluster.

**⚠ WARNING**

Be careful when accelerating temporarily, because the speed and distance is not controlled automatically even if there is a vehicle in front of you.

**Function temporarily canceled**

OCN7070052L

Smart Cruise Control will be temporarily canceled automatically when:

- The vehicle speed is above 130 mph (210 km/h)
- The vehicle is stopped for a certain period of time
- The accelerator pedal is continuously depressed for a certain period of time
- The conditions for the Smart Cruise Control to operate is not satisfied

If the function is temporarily canceled automatically, the 'Smart Cruise Control canceled' warning message will appear on the cluster, and an audible warning will sound to warn the driver.

If the Smart Cruise Control is temporarily canceled while the vehicle is at a standstill with the system operating, EPB (Electronic Parking Brake) maybe applied.

**WARNING**

When the function is temporarily canceled, distance with the front vehicle will not be maintained. Always have your eyes on the road while driving, and if necessary, depress the brake pedal to reduce your driving speed in order to maintain a safe distance.

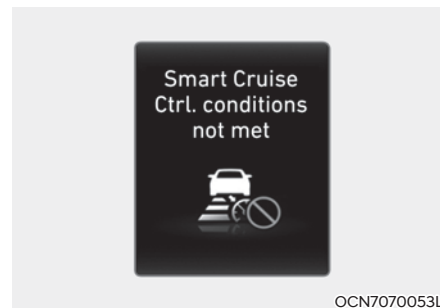
**Function conditions not satisfied**

OCN7070053L

If the Driving Assist button, + switch, - switch or  switch is pushed when the system's operating conditions are not satisfied, the 'Smart Cruise Control conditions not met' will appear on the cluster, and an audible warning will sound.

### In traffic situation



In traffic, your vehicle will stop if the vehicle ahead of you stops. Also, if the vehicle ahead of you starts moving, your vehicle will start as well. In addition, after the vehicle has stopped and a certain time have passed, the 'Use switch or pedal to accelerate' message will appear on the cluster. Depress the accelerator pedal or push the + switch, - switch or II switch to start driving.

#### **WARNING**

While the message is displayed on the cluster, if there is no vehicle in front or the vehicle is far away from you, and the + switch, - switch or II switch is pushed, Smart Cruise Control will automatically cancel and EPB will be applied. However, if the accelerator pedal is depressed, EPB will not be applied even though the system is canceled. Always pay attention to the road condition ahead.

### Warning road conditions ahead

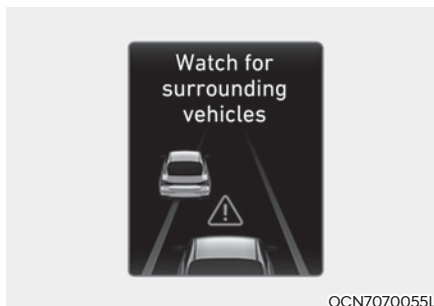

In the following situation, the 'Watch for surrounding vehicles' warning message will appear on the cluster, and an audible warning will sound to warn the driver of road conditions ahead.

- The vehicle in front disappears when Smart Cruise Control is maintaining the distance with the vehicle ahead while driving below a certain speed.
- While the 'Use switch or pedal to accelerate' message is displayed on the cluster, if there is no vehicle in front or the vehicle is far away from you, and the + switch, - switch or II switch is pushed.

#### **WARNING**

Always pay attention to vehicles or objects that may suddenly appear in front of you, and if necessary, depress the brake pedal to reduce your driving speed in order to maintain a safe distance.

### Collision Warning



While Smart Cruise Control is operating, when the collision risk with the vehicle ahead is high, the 'Collision Warning' warning message will appear on the cluster, and an audible warning will sound to warn the driver. Always have your eyes on the road while driving, and if necessary, depress the brake pedal to reduce your driving speed in order to maintain a safe distance.

### WARNING

In the following situations, Smart Cruise Control may not warn the driver of a collision.

- The distance from the front vehicle is near, or the vehicle speed of the front vehicle is faster or similar with your vehicle
- The speed of the front vehicle is very slow or is at a standstill
- The accelerator pedal is depressed right after Smart Cruise Control is turned on

### WARNING

Take the following precautions when using Smart Cruise Control:

- Smart Cruise Control does not substitute for proper and safe driving. It is the responsibility of the driver to always check the speed and distance to the vehicle ahead.
- Smart Cruise Control may not recognize unexpected and sudden situations or complex driving situations, so always pay attention to driving conditions and control your vehicle speed.
- Keep Smart Cruise Control off when the system is not in use to avoid inadvertently setting a speed.
- Do not open the door or leave the vehicle when Smart Cruise Control is operating, even if the vehicle is stopped.
- Always be aware of the selected speed and vehicle distance.
- Keep a safe distance according to road conditions and vehicle speed. If the vehicle distance is too close during high-speed driving, a serious collision may result.
- When maintaining distance with the vehicle ahead, if the front vehicle disappears, the system may suddenly accelerate to the set speed. Always be aware of unexpected and sudden situations from occurring.
- Vehicle speed may decrease on an upward slope and increase on a downward slope.
- Always be aware of situations such as when a vehicle cuts in suddenly.

- When you are towing a trailer or another vehicle, we recommend that Smart Cruise Control is turned off due to safety reasons.
- Turn off Smart Cruise Control when your vehicle is being towed.
- Smart Cruise Control may not operate normally if interfered by strong electromagnetic waves.
- Smart Cruise Control may not detect an obstacle in front and lead to a collision. Always look ahead cautiously to prevent unexpected and sudden situations from occurring.
- Vehicles moving in front of you with a frequent lane change may cause a delay in the system's reaction or may cause the system to react to a vehicle actually in an adjacent lane. Always drive cautiously to prevent unexpected and sudden situations from occurring.
- Always be aware of the surroundings and drive safely, even though a warning message does not appear or an audible warning does not sound.
- If any other system's warning message is displayed or warning sound is generated, Smart Cruise Control warning message may not be displayed and warning sound may not be generated.
- You may not hear the warning sound of Forward Collision-Avoidance Assist if the surrounding is noisy.
- The vehicle manufacturer is not responsible for any traffic violation or accidents caused by the driver.
- Always set the vehicle speed to the speed limit in your locality.

### **i** Information

- Smart Cruise Control may not operate for 15 seconds after the vehicle is started or the front view camera or front radar is initialized.
- You may hear a sound when the brake is controlled by Smart Cruise Control.

### Function malfunction and limitations

#### *Function malfunction*

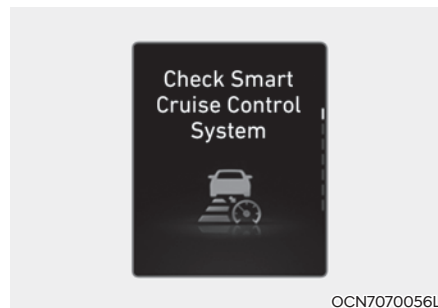

When Smart Cruise Control is not working properly, the 'Check Smart Cruise Control system' warning message will appear, and the  warning light will illuminate on the cluster. We recommend that the function be inspected by an authorized HYUNDAI dealer.



### Function disabled

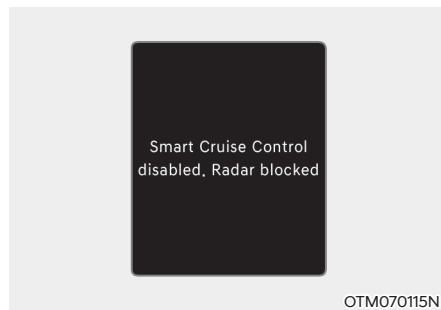

When the front radar cover or sensor is covered with snow, rain, or foreign material, it can reduce the detecting performance and temporarily limit or disable Smart Cruise Control.

If this occurs the 'Smart Cruise Control disabled. Radar blocked' warning message will appear for a certain period of time on the cluster.

The system will operate normally when snow, rain or foreign material is removed.



### WARNING

- **Even though the warning message does not appear on the cluster, Smart Cruise Control may not properly operate.**
- **Smart Cruise Control may not properly operate in an area (e.g. open terrain), where there is nothing to detect after turning ON the engine.**

### Limitations of the function

Smart Cruise Control may not operate normally, or the system may operate unexpectedly under the following circumstances:

- The detecting sensor or the surroundings are contaminated or damaged
- Washer fluid is continuously sprayed, or the wiper is on
- The camera lens is contaminated due to tinted, filmed or coated windshield, damaged glass, or stuck of foreign material (sticker, bug, etc.) on the glass
- Moisture is not removed or frozen on the windshield
- The field of view of the front view camera is obstructed by sun glare
- Street light or light from an oncoming vehicle is reflected on the wet road surface, such as a puddle on the road
- The temperature around the front view camera is high or low
- An object is placed on the dashboard
- The surrounding is very bright
- The surrounding is very dark, such as in a tunnel, etc.
- The brightness changes suddenly, for example when entering or exiting a tunnel
- The brightness outside is low, and the headlamps are not on or are not bright
- Driving in heavy rain or snow, or thick fog
- Driving through steam, smoke or shadow

- Only part of the vehicle is detected
- The vehicle in front has no tail lights, tail lights are located unusually, etc.
- The brightness outside is low, and the tail lamps are not on or are not bright
- The rear of the front vehicle is small or does not look normal (i.e. tilted, overturned, etc.)
- The front vehicle's ground clearance is low or high
- A vehicle suddenly cuts in front
- Your vehicle is being towed
- Driving through a tunnel or iron bridge
- Driving near areas containing metal substances, such as a construction zone, railroad, etc.
- A material is near that reflects very well on the front radar, such as a guardrail, nearby vehicle, etc.
- The bumper around the front radar is impacted, damaged or the front radar is out of position
- The temperature around the front radar is high or low
- Driving in large areas where there are few vehicles or structures (i.e. desert, meadow, suburb, etc.)
- The vehicle in front is made of material that does not reflect on the front radar
- Driving near a highway (or motorway) interchange or tollgate
- Driving on a slippery surface due to snow, water puddle, ice, etc.
- Driving on a curved road
- The vehicle in front is detected late
- The vehicle in front is suddenly blocked by an obstacle
- The vehicle in front suddenly changes lane or suddenly reduces speed
- The vehicle in front is bent out of shape
- The front vehicle's speed is fast or slow
- With a vehicle in front, your vehicle changes lane at low speed
- The vehicle in front is covered with snow
- Unstable driving
- You are on a roundabout and the vehicle in front is not detected
- You are continuously driving in a circle
- Driving in a parking lot
- Driving through a construction area, unpaved road, partial paved road, uneven road, speed bumps, etc.
- Driving on an incline road, curved road, etc.
- Driving through a roadside with trees or streetlights
- The adverse road conditions cause excessive vehicle vibrations while driving
- Your vehicle height is low or high due to heavy loads, abnormal tire pressure, etc.
- Driving through a narrow road where trees or grass are overgrown
- There is interference by electromagnetic waves, such as driving in an area with strong radio waves or electrical noise

- Driving on a curve

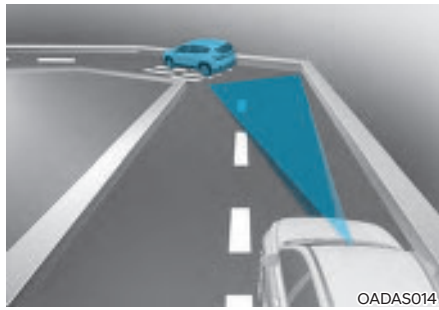

On curves, Smart Cruise Control may not detect a vehicle in the same lane, and may accelerate to the set speed. Also, vehicle speed may rapidly decrease when the vehicle ahead is detected suddenly.

Select the appropriate set speed on curves and apply the brake pedal or accelerator pedal according to the road and driving conditions ahead.



Your vehicle speed can be reduced due to a vehicle in the adjacent lane.

Apply the accelerator pedal and select the appropriate set speed. Check to be sure that the road conditions permit safe operation of the Smart Cruise Control.

- Driving on a slope



During uphill or downhill driving, the Smart Cruise Control may not detect a moving vehicle in your lane, and cause your vehicle to accelerate to the set speed. Also, vehicle speed will rapidly decrease when the vehicle ahead is detected suddenly.

Select the appropriate set speed on inclines and apply the brake pedal or accelerator pedal according to the road and driving conditions ahead.

- Changing lanes

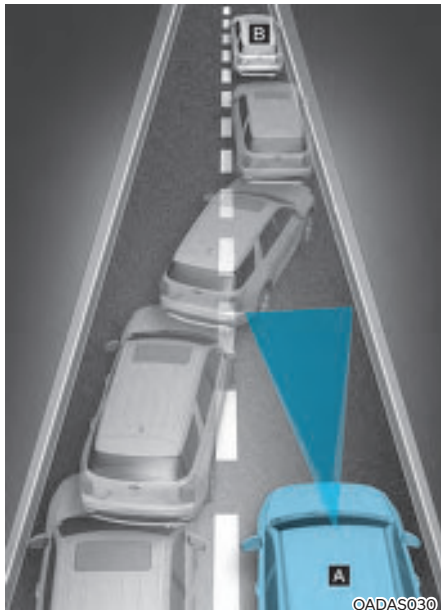

[A] : Your vehicle, [B] : Lane changing vehicle

When a vehicle moves into your lane from an adjacent lane, it cannot be detected by the sensor until it is in the sensor's detection range. Smart Cruise Control may not immediately detect the vehicle when the vehicle changes lanes abruptly. In this case, you must maintain a safe braking distance, and if necessary, depress the brake pedal to reduce your driving speed in order to maintain a safe distance.

- Detecting vehicle

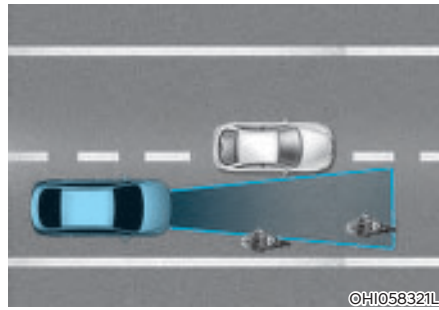

In the following cases, some vehicles in your lane cannot be detected by the sensor:

- Vehicles offset to one side
- Slow-moving vehicles or sudden-decelerating vehicles
- Oncoming vehicles
- Stopped vehicles
- Vehicles with small rear profile, such as trailers
- Narrow vehicles, such as motorcycles or bicycles
- Special vehicles
- Animals and pedestrians

Adjust your vehicle speed by depressing the brake pedal according to the road and driving conditions ahead.

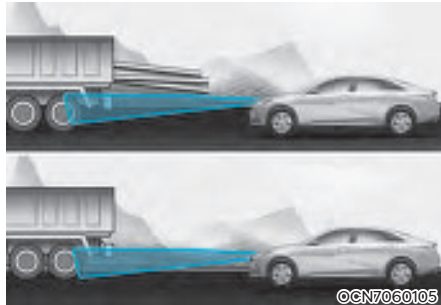

In the following cases, the vehicle in front cannot be detected by the sensor:

- Vehicles with higher ground clearance or vehicles carrying loads that stick out of the back of the vehicle
- Vehicles that has the front lifted due to heavy loads
- You are steering your vehicle
- Driving on narrow or sharply curved roads

Adjust your vehicle speed by depressing the brake pedal according to the road and driving conditions ahead.

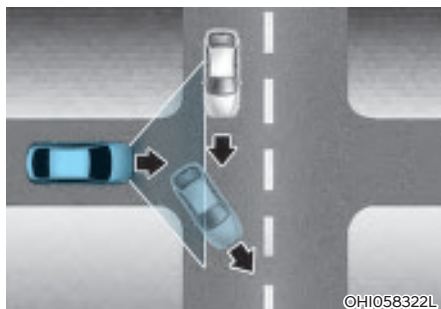

- When a vehicle ahead disappears at an intersection, your vehicle may accelerate.

Always pay attention to road and driving conditions while driving.

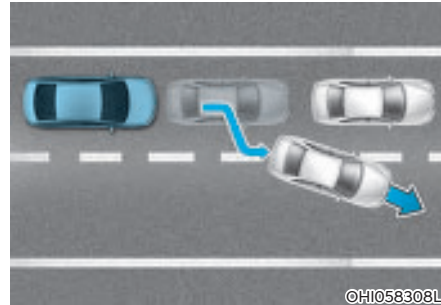

- When a vehicle in front of you merges out of the lane, Smart Cruise Control may not immediately detect the new vehicle that is now in front of you. Always pay attention to road and driving conditions while driving.

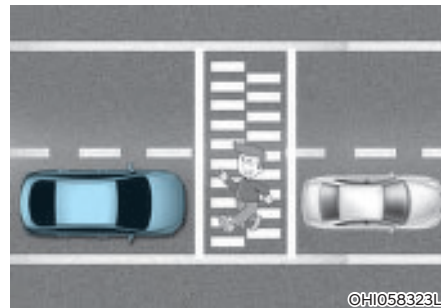

- Always look out for pedestrians when your vehicle is maintaining a distance with the vehicle ahead.

**i** Information

This device complies with Part 15 of the FCC rules.

Operation is subject to the following three conditions:

1. This device may not cause harmful interference, and
2. This device must accept any interference received, including interference that may cause undesired operation.
3. Changes or modifications not expressly approved by the party responsible for compliance could void the user's authority to operate the device.

**i** Information

Radio frequency radiation exposure information:

This equipment complies with FCC radiation exposure limits set forth for an uncontrolled environment.

This equipment should be installed and operated with minimum distance of 8 in. (20 cm) between the radiator (antenna) and your body.

This transmitter must not be co-located or operating in conjunction with any other antenna or transmitter.

## NAVIGATION-BASED SMART CRUISE CONTROL (NSCC) (IF EQUIPPED)

Navigation-based Smart Cruise Control can help automatically adjust vehicle speed when driving on highways (or motorways) by using road information from the navigation system while Smart Cruise Control is operating.

### **i** Information

- **Navigation-based Smart Cruise Control is available only on controlled access road of certain highways.**
  - \* **Controlled access road indicates roads with limited entrances and exits that allow uninterrupted high speed traffic flow. Only passenger cars and motorcycles are allowed on controlled access roads.**
- **Additional highways may be expanded by future navigation updates.**

### **i** Information

Navigation-based Smart Cruise Control operates on main roads of highways (or motorways), and does not operate on interchanges or junctions.

#### Highway Curve Zone Auto Slowdown

If vehicle speed is high, Highway Curve Zone Auto Slowdown function can temporarily decelerate your vehicle or limit acceleration to help you drive on a curve based on the curve information from the navigation.

#### Highway Set Speed Auto Change

Highway Set Speed Auto Change function automatically changes Smart Cruise Control set speed based on the speed limit information from the navigation.

### Function settings

#### Setting

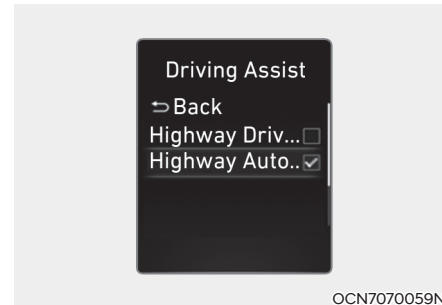

With the engine on, select 'Driver Assistance → Driving Assist → Highway Auto Speed Change' from the Settings menu to turn on Navigation-based Smart Cruise Control and deselect to turn off the system.

### **i** Information

**When there is a problem with Navigation-based Smart Cruise Control, the function cannot be set from the Settings menu.**

## Function operation

### Operating conditions

Navigation-based Smart Cruise Control is ready to operate if all of the following conditions are satisfied:

- Smart Cruise Control is operating
- Driving on main roads of highways (or motorways)

### Information

For more details on how to operate Smart Cruise Control, refer to “Smart Cruise Control (SCC)” section in chapter 7.

### Function display and control

When Navigation-based Smart Cruise Control operates, it will be displayed on the cluster as follows:

- Function standby



If the operating conditions are satisfied, the white **AUTO** indicator will illuminate.

- Function operating



If temporary deceleration is required in the standby state and Navigation-based Smart Cruise Control is operating, the green **AUTO** symbol will illuminate on the cluster.

If the Highway Set Speed Auto Change function operates, the green **AUTO** symbol and set speed will illuminate on the cluster, and an audible warning will sound.

### WARNING



**'Drive carefully' warning message will appear in the following circumstances:**

- Navigation-based Smart Cruise Control is not able to slow down your vehicle to a safe speed



### **i** Information



**Highway Curve Zone Auto Slowdown and Highway Set Speed Auto Change function uses the same **AUTO** symbol.**

#### **Highway Curve Zone Auto Slowdown**

- Depending on the curve ahead on the highway (or motorway), the vehicle will decelerate, and after passing the curve, the vehicle will accelerate to Smart Cruise Control set speed.
- Vehicle deceleration time may differ depending on the vehicle speed and the degree of the curve on the road. The higher the driving speed, deceleration will start faster.

#### **Highway Set Speed Auto Change**

- Highway Set Speed Auto Change function will operate when Smart Cruise Control set speed and the highway (or motorway) speed limit is matched.
- While Highway Set Speed Auto Change function is operating, when the highway (or motorway) speed limit changes, Smart Cruise Control set speed automatically changes to the changed speed limit.
- If Smart Cruise Control set speed is adjusted different from the speed limit, Highway Set Speed Auto Change function will be in the standby state.
- If Highway Set Speed Auto Change function has changed to the standby state by driving on a road other than the highway (or motorway) main road, Highway Set Speed Auto Change function will operate again when you drive on the main road again without setting the set speed.

- If Highway Set Speed Auto Change function has changed to the standby state by depressing the brake pedal or pressing the **||**  switch on the steering wheel, press the **||**  switch to restart the function.
- Highway Set Speed Auto Change function does not operate on highway interchanges or junctions.

### **i** Information

- **Highway Set Speed Auto Change function only operates based on the speed limits of the highway (or motorway), it does not work with speed cameras.**
- **When Highway Set Speed Auto Change function is operating, the vehicle automatically accelerates or decelerates when the highway (or motorway) speed limit changes.**
- **The maximum set speed for Highway Set Speed Auto Change function is 86 mph (140 km/h).**
- **If the speed limit of a new road is not updated in the navigation, Highway Set Speed Auto Change function may not operate properly.**
- **If the speed unit is set to a unit other than the speed unit used in your country, Highway Set Speed Auto Change function may not operate properly.**

### Limitations of the function

Navigation-based Smart Cruise Control may not operate normally under the following circumstances:

- The navigation is not working properly
- Speed limit and road information in the navigation is not updated
- The map information and the actual road is different because of real-time GPS data or map information error
- The navigation searches for a route while driving
- GPS signals are blocked in areas such as a tunnel
- The navigation is updated while driving
- Map information is not transmitted due to infotainment system's abnormal operation
- A road that divides into two or more roads and joins again
- The driver goes off course the route set in the navigation
- The route to the destination is changed or canceled by resetting the navigation
- The vehicle enters a service station or rest area
- The speed limit of some sections changes according to the road situations
- Android Auto or Car Play is operating
- The navigation cannot detect the current vehicle position (ex: elevated roads including overpass adjacent to general roads or nearby roads exist in a parallel way)
- The navigation is being updated while driving
- The navigation is being restarted while driving
- There is bad weather, such as heavy rain, heavy snow, etc.
- Driving on a road under construction
- Driving on a road that is controlled
- Driving on a road that is sharply curved
- Driving on roads with intersections, roundabouts, straight entrances and exits, etc.

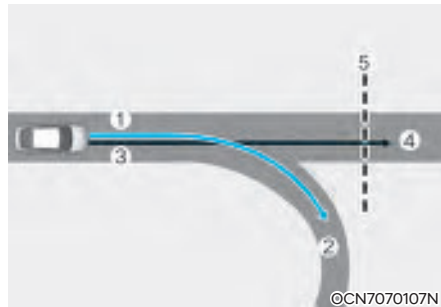

[1] : Set route, [2] : Branch line, [3] : Driving route,  
[4] : Main road, [5] : Curved road section

- When there is a difference between the navigation set route (branch line) and the driving route (main road), Highway Curve Zone Auto Slowdown function may not operate until the driving route is recognized as the main road.
- When the vehicle's driving route is recognized as the main road by maintaining the main road instead of the navigation set route, Highway Curve Zone Auto Slowdown function will operate. Depending on the distance to the curve and the current vehicle speed, vehicle deceleration may not be sufficient or may decelerate rapidly.

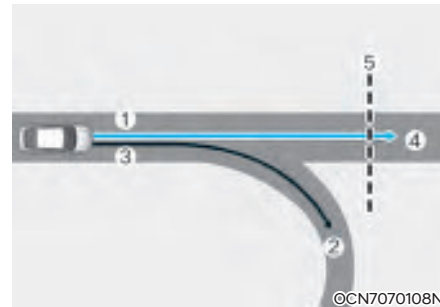

[1] : Set route, [2] : Branch line, [3] : Driving route,  
[4] : Main road, [5] : Curved road section

- When there is a difference between the navigation route (main road) and the driving route (branch line), Highway Curve Zone Auto Slowdown function will operate based on the curve information on the main road.
- When it is judged that you are driving out of the route by entering the highway interchange or junction, Highway Curve Zone Auto Slowdown function will not operate.

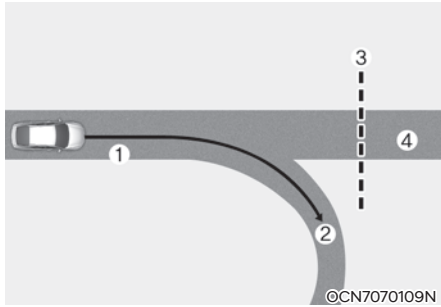

[1] : Driving route, [2] : Branch line,  
[3] : Curved road section, [4] : Main road

- If there is no destination set on the navigation, Highway Curve Zone Auto Slowdown function will operate based on the curve information on the main road.
- Even if you depart from the main road, Highway Curve Zone Auto Slowdown function may temporarily operate due to navigation information of the highway curve section.

#### **WARNING**

- **Navigation-based Smart Cruise Control is not a substitute for safe driving practices, but a convenience function. Always have your eyes on the road, and it is the responsibility of the driver to avoid violating traffic laws.**
- **The navigation's speed limit information may differ from the actual speed limit information on the road. It is the driver's responsibility to check the speed limit on the actual driving road or lane.**
- **Navigation-based Smart Cruise Control will automatically be cancelled when you leave the highway (or motorway) main road. Always pay attention to road and driving conditions while driving.**
- **Navigation-based Smart Cruise Control may not operate due to the existence of leading vehicles and the driving conditions of the vehicle. Always pay attention to road and driving conditions while driving.**
- **When you are towing a trailer or another vehicle, we recommend that Navigation-based Smart Cruise Control is turned off due to safety reasons.**

- After you pass through a tollgate on a highway (or motorway), Navigation-based Smart Cruise Control will operate based on the first lane. If you enter one of the other lanes, the system may not operate properly.
- The vehicle will accelerate if the driver depresses the accelerator pedal while Navigation-based Smart Cruise Control is operating, and the system will not decelerate the vehicle.
- If the driver accelerates and releases the accelerator pedal while Navigation-based Smart Cruise Control is operating, the vehicle may not decelerate sufficiently or may rapidly decelerate to a safe speed.
- If the curve is too large or too small, Navigation-based Smart Cruise Control may not operate.

### **i** Information

- The time gap could occur between the navigation's guidance and when Navigation-based Smart Cruise Control operation starts and ends.
- The speed information on the cluster and navigation may differ.
- Even if you are driving at a speed lower than Smart Cruise Control set speed, acceleration may be limited by the curve sections ahead.
- If Navigation-based Smart Cruise Control is operating while leaving the main road to enter an interchange, junction, rest area, etc., the system may operate for a certain period of time.
- Deceleration by Navigation-based Smart Cruise Control may feel it is not sufficient due to road conditions such as uneven road surfaces, narrow lanes, etc.

### **i** Information

This device complies with Part 15 of the FCC rules.

Operation is subject to the following three conditions:

1. This device may not cause harmful interference, and
2. This device must accept any interference received, including interference that may cause undesired operation.
3. Changes or modifications not expressly approved by the party responsible for compliance could void the user's authority to operate the device.

### **i** Information

Radio frequency radiation exposure information:

This equipment complies with FCC radiation exposure limits set forth for an uncontrolled environment.

This equipment should be installed and operated with minimum distance of 8 in. (20 cm) between the radiator (antenna) and your body.

This transmitter must not be co-located or operating in conjunction with any other antenna or transmitter.

## LANE FOLLOWING ASSIST (LFA) (IF EQUIPPED)

Lane Following Assist is designed to help detect lane markings and/or vehicles on the road, and assists the driver's steering to help center the vehicle in the lane.

### Detecting sensor



[1] : Front view camera

The front view camera is used as a detecting sensor to help detect lane markings and vehicles in front.

Refer to the picture above for the detailed location of the detecting sensor.



### CAUTION

For more details on the precautions of the front view camera, refer to "Forward Collision-Avoidance Assist (FCA)" section in chapter 7.

### Function settings

#### Setting

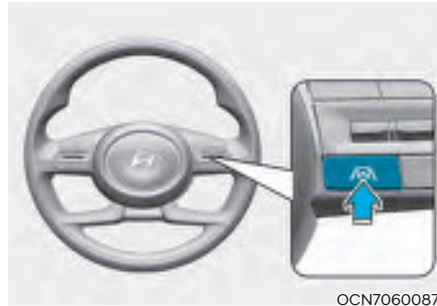

#### Turning the function ON/OFF

With the engine on, shortly press the Lane Driving Assist button located on the steering wheel to turn on Lane Following Assist. The white or green  indicator light will illuminate on the cluster.

Press the button again to turn off the system.

If the engine is restarted, Lane Following Assist will maintain the last setting.

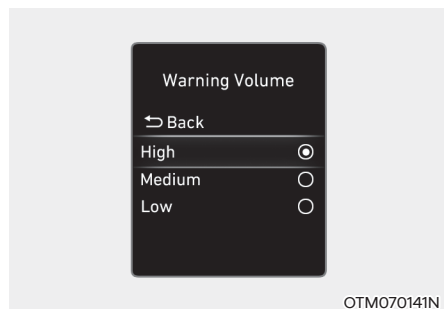

### Warning Volume

With the engine on, select 'Driver Assistance → Warning Volume' from the Settings menu to change the Warning Volume to 'High', 'Medium' or 'Low' for Hands-off warning.

If you change the Warning Volume, the Warning Volume of other Driver Assistance systems may change.

## Function operation

### Warning and control

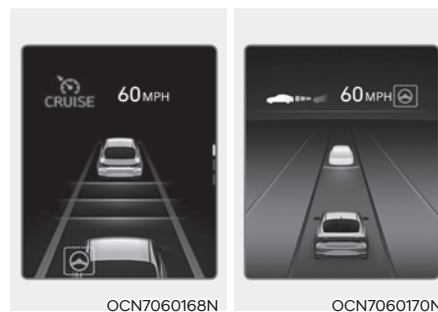

### Lane Following Assist

If the vehicle ahead and/or both lane markings are detected and your vehicle speed is below 112 mph (180 km/h), the green  indicator light will illuminate on the cluster, and the function will help center the vehicle in the lane by assisting the steering wheel.



### CAUTION

When the steering wheel is not assisted, the green  indicator light will blink and change to white.



#### Hands-off warning

If the driver takes their hands off the steering wheel for several seconds, the 'Place hands on the steering wheel' warning message will appear and an audible warning will sound in stages.

First stage : Warning message

Second stage : Warning message (red steering wheel) and audible warning

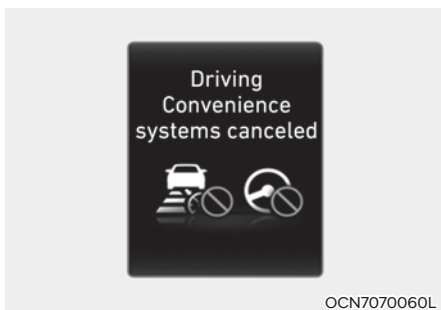

If the driver still does not have their hands on the steering wheel after the hands-off warning, the 'Driving Convenience systems canceled' warning message will appear and Lane Following Assist will be automatically canceled.

#### WARNING

- Lane Following Assist does not operate at all times. It is the responsibility of the driver to safely steer the vehicle and to maintain the vehicle in its lane.
- The hands-off warning message may appear late depending on road conditions. Always have your hands on the steering wheel while driving.
- If the steering wheel is held very lightly the hands-off warning message may appear because the system may not recognize that the driver has their hands on the steering wheel.
- If you attach objects to the steering wheel, the hands-off warning may not work properly.

#### Information

- You may change settings from the instrument cluster (User Settings) or infotainment system (Vehicle Settings), whichever option that is provided with your vehicle. For more details, see "User Settings" section in chapter 4, or "Vehicle Settings" section in supplied Infotainment Manual.
- When both lane markings are detected, the lane lines on the cluster will change from grey to white.





- If lane markings are not detected, steering wheel control by Lane Following Assist can be limited depending on whether a vehicle is in front or the driving conditions of the vehicle.
- Even though the steering is assisted by Lane Following Assist, the driver may control the steering wheel.
- The steering wheel may feel heavier or lighter when the steering wheel is assisted by Lane Following Assist than when it is not.

## Function malfunction and limitations

### Function malfunction

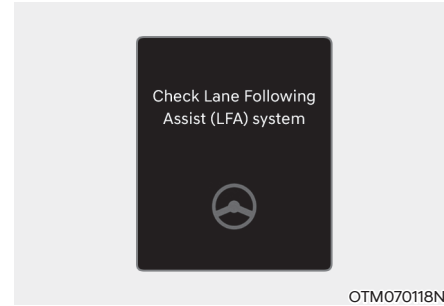

When Lane Following Assist is not working properly, the 'Check Lane Following Assist (LFA) system' warning message will appear on the cluster. If this occurs, we recommend that the function be inspected by an authorized HYUNDAI dealer.



### WARNING

For more details on the system precautions, refer to "Lane Keeping Assist (LKA)" section in chapter 7.

### Limitations of the function

For more details on function limitations, refer to "Lane Keeping Assist (LKA)" section in chapter 7.

## HIGHWAY DRIVING ASSIST (HDA) (IF EQUIPPED)

### Basic function

Highway Driving Assist is designed to help detect vehicles and lanes ahead, and help maintain distance from the vehicle ahead, maintain the set speed, and help center the vehicle in the lane while driving on the highway (or motorway).

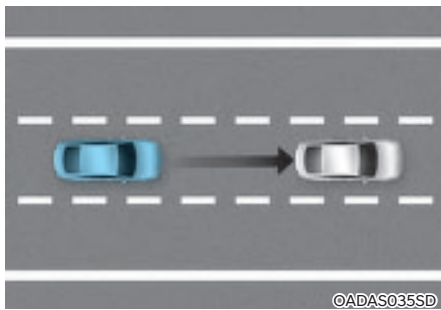

### **i** Information

- Highway Driving Assist is available only on controlled access road of certain highways.
  - \* Controlled access road indicates roads with limited entrances and exits that allow uninterrupted high speed traffic flow. Only passenger cars and motorcycles are allowed on controlled access roads.
- Additional highways may be expanded by future navigation updates.

### Detecting sensor



- [1] : Front view camera,
- [2] : Front radar

Refer to the picture above for the detailed location of the detecting sensors.

### **⚠** CAUTION

For more details on the precautions of the detecting sensors, refer to “Forward Collision-Avoidance Assist (FCA)” section in chapter 7.

## Function settings

### Setting functions for the system



#### Highway Driving Assist

With the engine on, select 'Driver Assistance → Driving Assist' from the Settings menu to set whether or not to use the following function(s).

- If 'Highway Driving Assist' is selected, it helps maintain distance from the vehicle ahead, maintain the set speed, and helps center the vehicle in the lane.

## **i** Information

- If there is a problem with the function(s), the settings cannot be changed. We recommend that the system be inspected by an authorized HYUNDAI dealer.
- If the engine is restarted, the function(s) will maintain the last setting.

## **!** WARNING

For your safety, change the Settings after parking the vehicle at a safe location.

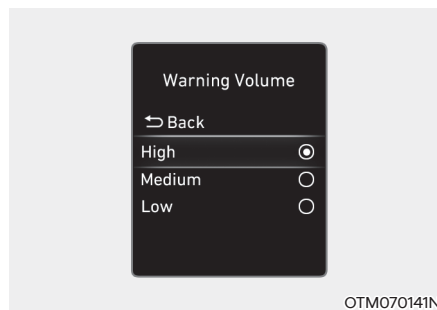

#### Warning Volume

With the engine on, select 'Driver Assistance → Warning Volume' from the Settings menu to change the Warning Volume to 'High', 'Medium' or 'Low' for Highway Driving Assist system.

If you change the Warning Volume, the Warning Volume of other Driver Assistance systems may change.

## Function operation

### Basic function

#### System display and control

You can see the status of the Highway Driving Assist operation in the Driving Assist mode on the cluster. Refer to “LCD Display Modes” section in chapter 4.

Highway Driving Assist will be displayed as below depending on the status of the system.

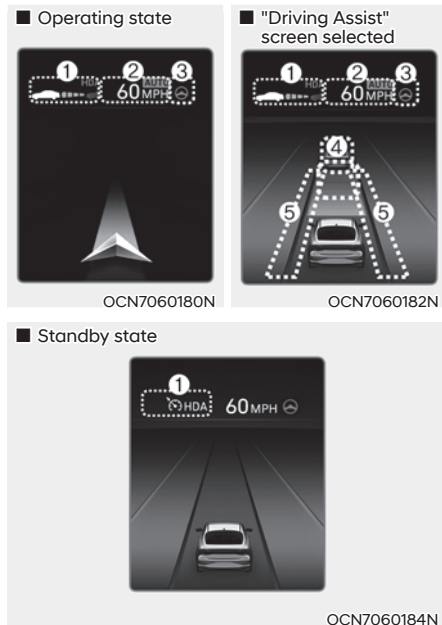

- (1) Highway Driving Assist indicator, whether there is a vehicle ahead and the selected distance level are displayed.

\* Highway Driving Assist indicator

- Green **[HDA]**: Operating state
- White **[HDA]**: Standby state

- (2) Set speed is displayed.
- (3) Lane Following Assist indicator displayed.
- (4) Whether there is a vehicle ahead and the selected vehicle distance are displayed.
- (5) Whether the lane is detected or not is displayed.

**For more details on the display refer to “Smart Cruise Control (SCC)” and “Lane Following Assist (LFA)” sections in chapter 7.**

#### Function operating

Highway Driving Assist will operate when entering or driving on the main road of highways (or motorways), and satisfying all the following conditions:

- Lane Following Assist is operating
- Smart Cruise Control is operating

### **i** Information

- **While driving on the highway (or motorway), if Smart Cruise Control starts operating, Highway Driving Assist will operate.**
- **When entering the main roads of highways (or motorways), Highway Driving Assist will not turn on if the Lane Following Assist is turned off even when Smart Cruise Control is operating.**

- Restarting after stopping



When Highway Driving Assist is operating, your vehicle will stop if the vehicle ahead of you stops. Also, if the vehicle ahead of you starts moving within 30 seconds after the stop, your vehicle will start as well. In addition, after the vehicle has stopped and 30 seconds have passed, the 'Use switch or pedal to accelerate' message will appear on the cluster. Depress the accelerator pedal or push the + switch, - switch or  switch to start driving.

- Hands-off warning



If the driver takes their hands off the steering wheel for several seconds, the 'Place hands on the steering wheel' warning message will appear and an audible warning will sound in stages.

First stage : Warning message

Second stage : Warning message (red steering wheel) and audible warning

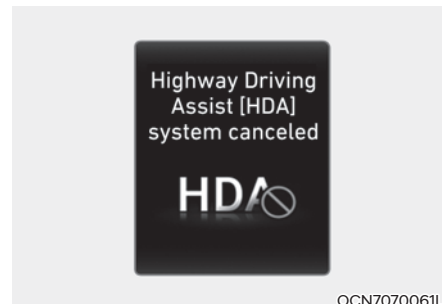

If the driver still does not have their hands on the steering wheel after the hands-off warning, the 'Highway Driving Assist (HDA) system canceled' warning message will appear and Highway Driving Assist and Lane Change Assist will be automatically canceled.

### Function standby

When Smart Cruise Control is temporarily canceled while Highway Driving Assist is operating, Highway Driving Assist will be in the standby state. At this time, Lane Following Assist will operate normally.

### Function malfunction and limitations

#### System malfunction

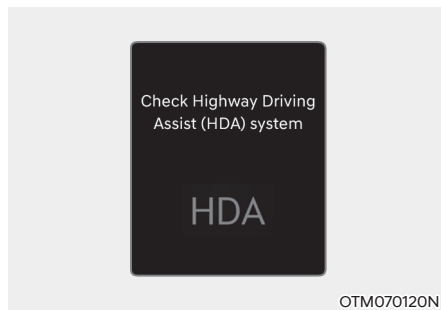

When Highway Driving Assist or Highway Lane Change function is not working properly, the 'Check Highway Driving Assist (HDA) system' warning message will appear, and the  warning light will illuminate on the cluster. We recommend that the function be inspected by an authorized HYUNDAI dealer.

### WARNING

- **The driver is responsible for controlling the vehicle for safe driving.**
- **Always have your hands on the steering wheel while driving.**
- **Highway Driving Assist is a supplemental function that assists the driver in driving the vehicle and is not a complete autonomous driving system. Always check road conditions, and if necessary, take appropriate actions to drive safely.**
- **Always have your eyes on the road, and it is the responsibility of the driver to avoid violating traffic laws. The vehicle manufacturer is not responsible for any traffic violation or accidents caused by the driver.**
- **Highway Driving Assist may not be able to recognize all traffic situations. The function may not detect possible collisions due to limitations of the system. Always be aware of the limitations of the system. Obstacles such as vehicles, motorcycles, bicycles, pedestrians, unspecified objects, structures, etc. that may collide with the vehicle may not be detected.**
- **Highway Driving Assist will turn off automatically under the following situations:**
  - **Driving on roads that the system does not operate, such as a rest area, intersection, junction, etc.**
  - **The navigation does not operate properly such as when the navigation is being updated or restarted**

- **Highway Driving Assist may inadvertently operate or turn off depending on road conditions (navigation information) and surroundings.**
- **Lane Following Assist function may be temporarily disabled when the front view camera cannot detect lanes properly or the hands-off warning is on.**
- **You may not hear the warning sound of Highway Driving Assist if the surrounding is noisy.**
- **If the vehicle is driven at high speed above a certain speed at a curve, your vehicle may drive to one side or may depart from the driving lane.**
- **When you are towing a trailer or another vehicle, we recommend that Highway Driving Assist is turned off due to safety reasons.**
- **The hands-off warning message may appear early or late depending on how the steering wheel is held or road conditions. Always have your hands on the steering wheel while driving.**
- **For your safety, please read the owner's manual before using the Highway Driving Assist.**
- **Highway Driving Assist will not operate when the engine is started, or when the detecting sensors or navigation is being initialized.**

### ***Limitations of the function***

Highway Driving Assist may not operate normally, or may not operate under the following circumstances:

- The map information and the actual road is different because the navigation is not updated
- The map information and the actual road is different because of real-time GPS data or map information error
- The infotainment system is overloaded by simultaneously performing functions such as route search, video playback, voice recognition, etc.
- GPS signals are blocked in areas such as a tunnel
- The driver goes off course or the route to the destination is changed or canceled by resetting the navigation
- The vehicle enters a service station or rest area
- Android Auto or Car Play is operating
- The navigation cannot detect the current vehicle position (ex: elevated roads including overpass adjacent to general roads or nearby roads exist in a parallel way)
- White single dotted lane line or road edge cannot be detected
- The road is temporarily controlled due to construction, etc.
- There is no structure, such as a medium strip, guardrails, etc., on the road
- There is a changeable lane in the direction of lane change

**For more details on the limitations of the front view camera, front radar, front corner radar and rear corner radar, refer to “Forward Collision-Avoidance Assist (FCA)” section in chapter 7.**

**i** Information

This device complies with Part 15 of the FCC rules.

Operation is subject to the following three conditions:

1. This device may not cause harmful interference, and
2. This device must accept any interference received, including interference that may cause undesired operation.
3. Changes or modifications not expressly approved by the party responsible for compliance could void the user's authority to operate the device.

**i** Information

Radio frequency radiation exposure information:

This equipment complies with FCC radiation exposure limits set forth for an uncontrolled environment.

This equipment should be installed and operated with minimum distance of 8 in. (20 cm) between the radiator (antenna) and your body.

This transmitter must not be co-located or operating in conjunction with any other antenna or transmitter.



**REAR VIEW MONITOR (RVM) (IF EQUIPPED)**

OCN7050046

***Detecting sensor***

OCN7050046L



OCN7050047

[1] : Rear view camera

Refer to the picture above for the detailed location of the detecting sensor.

Rear View Monitor will show the area behind the vehicle to assist you when parking or backing up.

## Function settings

### Camera settings

You can change Rear View Monitor settings by pressing the setup icon (⚙️) on the screen while the system is operating, or select 'Driver Assistance → Parking Safety → Camera Settings' from the Settings menu while the Engine Start/Stop button is in the ON position.

### Operating button



#### Parking/View button

Press the Parking/View button (1) to turn on Rear View Monitor.

Press the button again to turn off the function.

## Function operation

### Rear view with parking guidance

#### Operating conditions

- Shift the gear to R (Reverse), the image will appear on the screen.
- Press the Parking/View button (1) while the gear is in P (Park), the image will appear on the screen. However, parking guidance is not displayed.

#### Off conditions

- The rear view cannot be turned off when the gear is in R (Reverse).
- Press the Parking/View button (1) again while the gear is in P (Park) with the rear view on the screen, the rear view will turn off.
- Shift the gear from R (Reverse) to P (Park), the rear view will turn off.

### Maintaining rear view

The rear view will maintain showing on the screen to help you when parking. However, parking guidance is not displayed.

#### Operating conditions

Shift the gear from R (Reverse) to N (Neutral) or D (Drive), the rear view will appear on the screen.

#### Off conditions

- When vehicle speed is above 6 mph (10 km/h), the rear view will turn off.
- Shift the gear to P (Park), the rear view will turn off.

### Driving rear view



The driver is able to check the rear view on the screen while driving, it is to assist with safe driving.

#### Operating conditions

Press the Parking/View button (1) while the gear is in D (Drive) or N (Neutral), the driving rear view will appear on the screen.

#### Off conditions

- Press the Parking/View button (1) again, the driving rear view will turn off.
- Press one of the infotainment system button (2), the driving rear view will turn off.
- Shift the gear to P (Park), the driving rear view will turn off.

#### When operating

- If the gear is shifted to R (Reverse), while Driving rear view is displayed on the screen, the screen will change to rear view with parking guidance.
- When Driving rear view is displayed on the screen, an icon (📷) will appear on the upper right side of the screen indicating that the rear view is being displayed.

### **Rear top view**

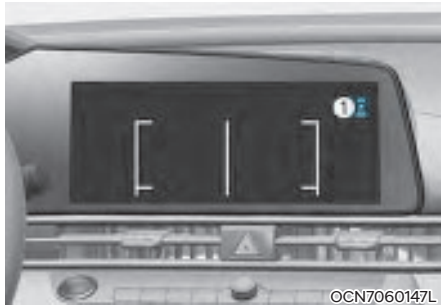

When you touch the icon (1), the top view is displayed on the screen and shows the distance from the vehicle in the back of your vehicle while parking.

### **Function malfunction and limitations**

#### **Function malfunction**

When Rear View Monitor is not working properly, or the screen flickers, or the camera image does not display normally, we recommend that the system be inspected by an authorized HYUNDAI dealer.

#### **Limitations of the function**

When the vehicle is stopped for a long time in winter or when the vehicle is parked in an indoor parking lot, the exhaust fumes may temporarily blur the image.



#### **WARNING**

- **The rear view camera does not cover the complete area behind the vehicle. The driver should always check the rear area directly through the inside and outside rearview mirror before parking or backing up.**
- **The image shown on the screen may differ from the actual distance of the object. Make sure to directly check the vehicle's surroundings for safety.**
- **Always keep the rear view camera lens clean. If the lens is covered with foreign material, it may adversely affect camera performance and Rear View Monitor may not operate normally.**

## REAR CROSS-TRAFFIC COLLISION WARNING (RCCW) (IF EQUIPPED)

Rear Cross-Traffic Collision Warning Assist is designed to help detect vehicles approaching from the left and right side while your vehicle is reversing, and warn the driver that a collision is imminent with a warning message and an audible warning.

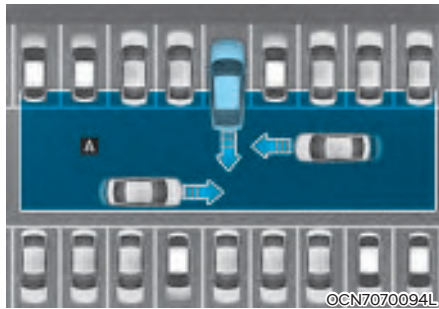

[A] : Rear Cross-Traffic Collision Warning operating range



### CAUTION

The time of warning may vary depending on vehicle speed of the approaching vehicle.



### Information

In the following text, Rear Cross-Traffic Collision Warning will be referred as Rear Cross-Traffic Safety system.

### Detecting sensor



[1] : Rear corner radar

Refer to the picture above for the detailed location of the detecting sensor.



### CAUTION

For more details on the precautions of the rear corner radar, refer to “Blind-Spot Collision-Avoidance Warning (BCW)” section in chapter 7.

## Function settings

### Setting



#### Rear Cross-Traffic Safety

With the engine on, select 'Driver Assistance → Parking Safety → Rear Cross-Traffic Safety' from the Settings menu to turn on Rear Cross-Traffic Safety system and deselect to turn off the system.



#### **WARNING**

**When the engine is restarted, Rear Cross-Traffic Safety system will always turn on. However, if 'Off' is selected after the engine is restarted, the driver should always be aware of the surroundings and drive safely.**

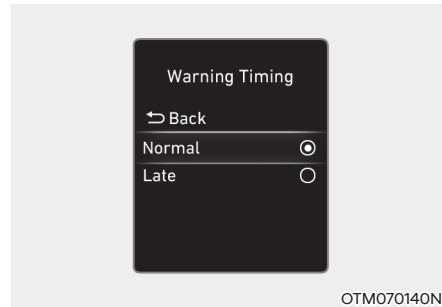

#### Warning Timing

With the engine on, select 'Driver Assistance → Warning Timing' from the Settings menu to change the initial warning activation time for Rear Cross-Traffic Safety system.

When the vehicle is first delivered, Warning Timing is set to 'Normal'. If you change the Warning Timing, the warning time of other Driver Assistance systems may change.

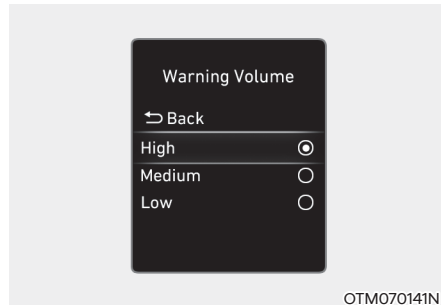

#### Warning Volume

With the engine on, select 'Driver Assistance → Warning Volume' from the Settings menu to change the Warning Volume to 'High', 'Medium' or 'Low' for Rear Cross-Traffic Safety system.

If you change the Warning Volume, the Warning Volume of other Driver Assistance systems may change.

#### CAUTION

- The setting of the Warning Timing and Warning Volume applies to all functions of the Rear Cross-Traffic Safety.
- Even though 'Normal' is selected for Warning Timing, if the vehicles from the left and right side approaches at high speed, the initial warning activation time may seem late.
- Select 'Late' for Warning Timing when traffic is light and when driving speed is slow.

#### Information

If the engine is restarted, Warning Timing and Warning Volume will maintain the last setting.

## Function operation

### Function warning

Rear Cross-Traffic Safety system will warn the driver when a collision is imminent.

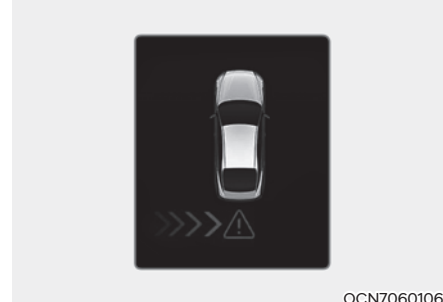

### Collision Warning

- To warn the driver of an approaching vehicle from the rear left/right side of your vehicle, the outside rearview mirror will blink and a warning will appear on the cluster. At the same time, an audible warning will sound. If the Rear View Monitor is operating, a warning will also appear on the infotainment system screen.

- The function will operate when all the following conditions are satisfied:
  - The gear is shifted to R (Reverse)
  - Vehicle speed is below 5 mph (8 km/h)
  - The approaching vehicle is within approximately 82 ft. (25 m) from the left and right side of your vehicle
  - The speed of the vehicle approaching from the left and right is above 3 mph (5 km/h)

### Information

If the operating conditions are satisfied, there will be a warning whenever the vehicle approaches from the left or right side even though your vehicle speed is 0 mph (0 km/h).

### WARNING

Take the following precautions when using Rear Cross-Traffic Safety system:

- For your safety, change the Settings after parking the vehicle at a safe location.
- If any other function's warning message is displayed or audible warning is generated, Rear Cross-Traffic Safety system's warning message may not be displayed and audible warning may not be generated.
- You may not hear the warning sound of Rear Cross-Traffic Safety system if the surrounding is noisy.
- Rear Cross-Traffic Safety system may warn the driver late or may not warn the driver depending on the road and driving conditions.
- The driver should hold the responsibility to control the vehicle. Do not solely depend on Rear Cross-Traffic Safety system. Rather, maintain a safe braking distance, and if necessary, depress the brake pedal to reduce driving speed or to stop the vehicle.



## Function malfunction and limitations

### Function malfunction

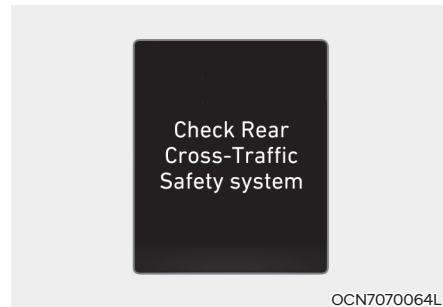

When Rear Cross-Traffic Safety system is not working properly, the 'Check Rear Cross-Traffic Safety system(s)' warning message will appear on the cluster, and the system will turn off automatically, or the system will be limited. We recommend that the system be inspected by an authorized HYUNDAI dealer.

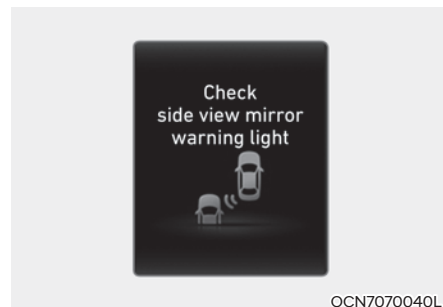

When the outside rearview mirror warning light is not working properly, the 'Check side view mirror warning light' warning message will appear on the cluster. We recommend that the system be inspected by an authorized HYUNDAI dealer.

### Function disabled



When the rear bumper around the rear corner radar or sensor is covered with foreign material, such as snow or rain, or installing a trailer or carrier, it can reduce the detecting performance and temporarily limit or disable Rear Cross-Traffic Safety system.

If this occurs, the 'Rear Cross-Traffic Safety system disabled. Radar blocked' warning message will appear on the cluster.

The system will operate normally when such foreign material or trailer, etc. is removed.

If the system does not operate normally after it is removed, we recommend that the system be inspected by an authorized HYUNDAI dealer.

 **WARNING**

- Even though the warning message does not appear on the cluster, Rear Cross-Traffic Safety system may not operate properly.
- Rear Cross-Traffic Safety system may not operate properly in an area (for example: open terrain), where any substance are not detected after turning ON the engine.

 **CAUTION**

Turn off Rear Cross-Traffic Safety system to install a trailer, carrier, etc., or remove the trailer, carrier, etc. to use Rear Cross-Traffic Safety system.

**Limitations of the function**

Rear Cross-Traffic Safety system may not operate normally, or the system may operate unexpectedly under the following circumstances:

- Departing from where trees or grass are overgrown
- Departing from where roads are wet
- Speed of the approaching vehicle is fast or slow

For more details on the limitations of the rear corner radar, refer to “Blind-Spot Collision-Avoidance Warning (BCW)” section in chapter 7.

 **WARNING**

- Driving near a vehicle or structure

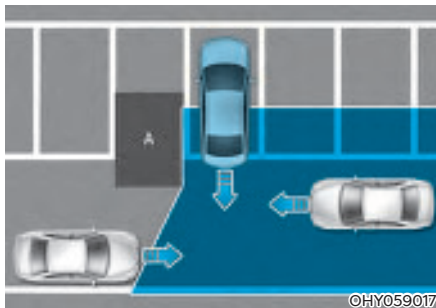

[A] : Structure

Rear Cross-Traffic Safety system may be limited when driving near a vehicle or structure, and may not detect the vehicle approaching from the left or right. If this occurs, the system may not warn the driver when necessary.

**Always check your surroundings while backing up.**

- When the vehicle is in a complex parking environment

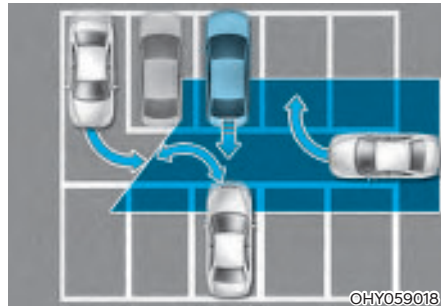

Rear Cross-Traffic Safety system may detect vehicles which are parking or pulling out near your vehicle (for example: a vehicle leaving beside your vehicle, a vehicle parking or pulling out in the rear area, a vehicle approaching your vehicle making a turn, etc.). If this occurs, the system may unnecessarily warn the driver. Always check your surroundings while backing up.

- When the vehicle is parked diagonally



[A] : Vehicle

Rear Cross-Traffic Safety system may be limited when backing up diagonally, and may not detect the vehicle approaching from the left or right. If this occurs, the system may not warn the driver when necessary. Always check your surroundings while backing up.

- When the vehicle is on or near a slope

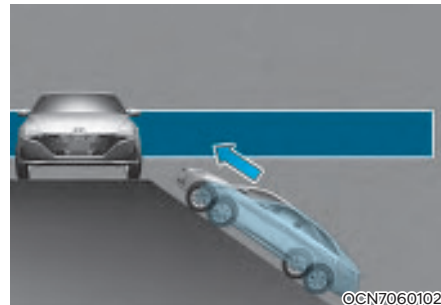

Rear Cross-Traffic Safety system may be limited when the vehicle is on a uphill or downhill slope, or near it, and may not detect the vehicle approaching from the left or right. If this occurs, the system may not warn the driver when necessary. Always check your surroundings while backing up.

- Pulling into the parking space where there is a structure

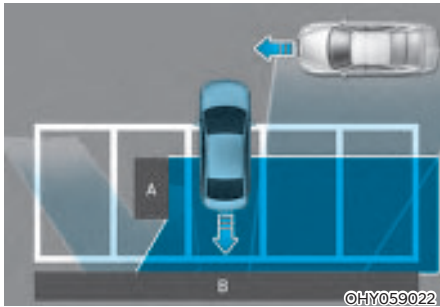

[A] : Structure, [B] :Wall

Rear Cross-Traffic Safety system may detect vehicles passing by in front of you when parking in reverse into a parking space with a wall or structure in the rear or side area. If this occurs, the system may unnecessarily warn the driver.

Always check your surroundings while backing up.

- When the vehicle is parked rearward

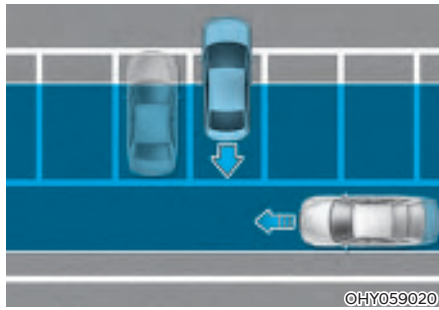

Rear Cross-Traffic Safety system may detect vehicles passing by behind you when parking in reverse into a parking space. If this occurs, the system may unnecessarily warn the driver.

Always check your surroundings while backing up.

 **WARNING**

- Rear Cross-Traffic Safety system may not operate normally if interfered by strong electromagnetic waves.
- Rear Cross-Traffic Safety system may not operate for 3 seconds after the vehicle is started, or the rear corner radars are initialized.

## REAR CROSS-TRAFFIC COLLISION-AVOIDANCE ASSIST (RCCA) (IF EQUIPPED)

Rear Cross-Traffic Collision-Avoidance Assist is designed to help detect vehicles approaching from the left and right side while your vehicle is reversing, and warn the driver that a collision is imminent with a warning message and an audible warning. Also, braking is assisted to help prevent a collision.

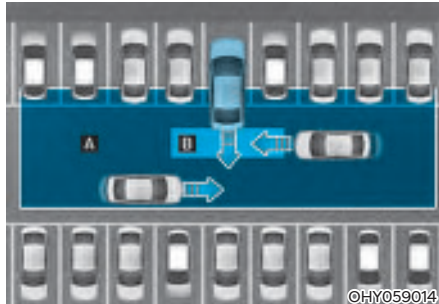

[A] : Rear Cross-Traffic Collision Warning operating range,

[B] : Rear Cross-Traffic Collision-Avoidance Assist operating range



### CAUTION

The time of warning may vary depending on vehicle speed of the approaching vehicle.



### Information

In the following text, Rear Cross-Traffic Collision Warning and Rear Cross-Traffic Collision-Avoidance Assist will be referred as Rear Cross-Traffic Safety system.

### Detecting sensor



[1] : Rear corner radar

Refer to the picture above for the detailed location of the detecting sensors.



### CAUTION

For more details on the precautions of the rear corner radar, refer to “Blind-Spot Collision-Avoidance Assist (BCA)” section in chapter 7.

## Function settings

### Setting

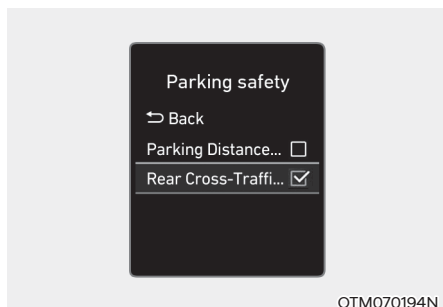

#### Rear Cross-Traffic Safety

With the engine on, select 'Driver Assistance → Parking Safety → Rear Cross-Traffic Safety' from the Settings menu to turn on Rear Cross-Traffic Safety system and deselect to turn off the system.



#### WARNING

**When the engine is restarted, Rear Cross-Traffic Safety system will always turn on. However, if 'Off' is selected after the engine is restarted, the driver should always be aware of the surroundings and drive safely.**



#### Information

Settings for Rear Cross-Traffic Safety system include Rear Cross-Traffic Collision Warning and Rear Cross-Traffic Collision-Avoidance Assist.

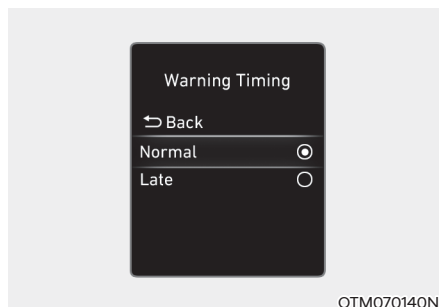

#### Warning Timing

With the engine on, select 'Driver Assistance → Warning Timing' from the Settings menu to change the initial warning activation time for Rear Cross-Traffic Safety system.

When the vehicle is first delivered, Warning Timing is set to 'Normal'. If you change the Warning Timing, the warning time of other Driver Assistance systems may change.

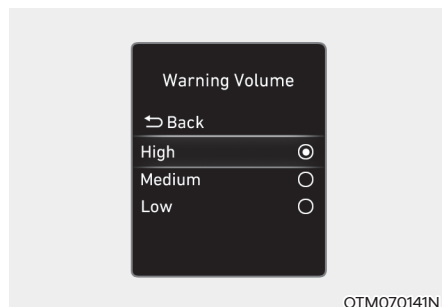

OTM070141N

### Warning Volume

With the engine on, select 'Driver Assistance → Warning Volume' from the Settings menu to change the Warning Volume to 'High', 'Medium' or 'Low' for Rear Cross-Traffic Safety system.

If you change the Warning Volume, the Warning Volume of other Driver Assistance systems may change.



### CAUTION

- The setting of the Warning Timing and Warning Volume applies to all functions of the Rear Collision-Avoidance Assist.
- Even though 'Normal' is selected for Warning Timing, if the vehicles from the left and right side approaches at high speed, the initial warning activation time may seem late.
- Select 'Late' for Warning Timing when traffic is light and when driving speed is slow.



### Information

If the engine is restarted, Warning Timing and Warning Volume will maintain the last setting.

## Function operation

### Function warning and control

Rear Cross-Traffic Safety system will warn and control the vehicle depending on collision level: 'Collision Warning', 'Emergency Braking' and 'Stopping vehicle and ending brake control'.



OCN7060116

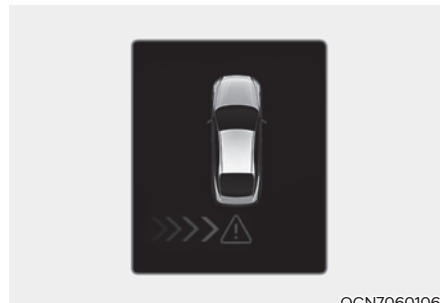

OCN7060106

### Collision Warning

- To warn the driver of an approaching vehicle from the rear left/right side of your vehicle, the warning light on the outside rearview mirror will blink and a warning will appear on the cluster. At the same time, an audible warning will sound. If the Rear View Monitor is operating, a warning will also appear on the infotainment system screen.

- The function will operate when all the following conditions are satisfied:
  - The gear is shifted to R (Reverse)
  - Vehicle speed is below 5 mph (8 km/h)
  - The approaching vehicle is within approximately 82 ft. (25 m) from the left and right side of your vehicle
  - The speed of the vehicle approaching from the left and right is above 3 mph (5 km/h)

### **i** Information

If the operating conditions are satisfied, there will be a warning whenever the vehicle approaches from the left or right side even though your vehicle speed is 0 mph (0 km/h).

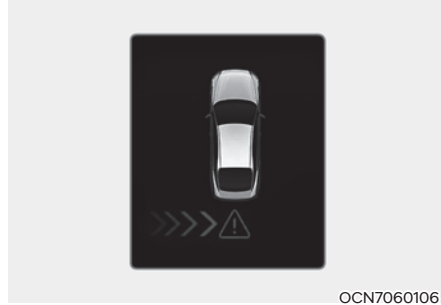

### Emergency Braking

- To warn the driver of an approaching vehicle from the rear left/right side of your vehicle, the warning light on the outside rearview mirror will blink and, the 'Emergency Braking' warning message will appear on the cluster. At the same time, an audible warning will sound. If the Rear View Monitor is operating, a warning will also appear on the infotainment system screen.



- The function will operate when all the following conditions are satisfied:
  - The gear is shifted to R (Reverse)
  - Vehicle speed is below 5 mph (8 km/h)
  - The approaching vehicle is within approximately 5 ft. (1.5 m) from the left and right side of your vehicle
  - The speed of the vehicle approaching from the left and right is above 3 mph (5 km/h)
- Emergency braking will be assisted to help prevent collision with approaching vehicles from the left and right.



### WARNING

#### Brake control will end when:

- **The approaching vehicle is out of the detecting range**
- **The approaching vehicle passes behind your vehicle**
- **The approaching vehicle does not drive toward your vehicle**
- **The approaching vehicle speed slows down**
- **The driver depresses the brake pedal with sufficient power**



#### Stopping vehicle and ending brake control

- When the vehicle is stopped due to emergency braking, the 'Drive carefully' warning message will appear on the cluster.
- For your safety, the driver should depress the brake pedal immediately and check the surroundings.
- Brake control will end after the vehicle is stopped by emergency braking for approximately 2 seconds.
- During emergency braking, braking control by the system will automatically cancel when the driver excessively depresses the brake pedal.

 **WARNING**

Take the following precautions when using Rear Cross-Traffic Safety system:

- For your safety, change the Settings after parking the vehicle at a safe location.
- If any other system's warning message is displayed or audible warning is generated, Rear Cross-Traffic Safety system's warning message may not be displayed and audible warning may not be generated.
- You may not hear the warning sound of Rear Cross-Traffic Safety system if the surrounding is noisy.
- Rear Cross-Traffic Safety system may not operate if the driver applies the brake pedal to avoid collision.
- During Rear Cross-Traffic Safety system operation, the vehicle may stop suddenly injuring passengers and shifting loose objects. Always have the seat belt on and keep loose objects secured.
- Even if there is a problem with Rear Cross-Traffic Safety system, the vehicle's basic braking performance will operate normally.
- Rear Cross-Traffic Safety system does not operate in all situations or cannot avoid all collisions.
- During emergency braking, braking control by the function will automatically cancel when the driver excessively depresses the accelerator pedal.

- The driver should hold the responsibility to control the vehicle. Do not solely depend on Rear Cross-Traffic Safety system. Rather, maintain a safe braking distance, and if necessary, depress the brake pedal to reduce driving speed or to stop the vehicle.
- Never deliberately operate Rear Cross-Traffic Safety system on people, animal, objects, etc. It may cause serious injury or death.

 **CAUTION**

The brake control may not operate properly depending on the status of ESC (Electronic Stability Control).

There will only be a warning when:

- The ESC (Electronic Stability Control) warning light is on
- ESC (Electronic Stability Control) is engaged in a different function

 **Information**

- If the system assists you with braking, the driver needs to pay attention as the brake assist will end within 2 seconds. The driver must immediately depress the brake pedal and check vehicle surroundings.
- Brake control will end when the driver depresses the brake pedal with sufficient power.
- After shifting the gear to R (Reverse), braking control will operate once for left and right vehicle approach.

## Function malfunction and limitations

### Function malfunction



When Rear Cross-Traffic Safety system is not working properly, the 'Check Rear Cross-Traffic Safety system' warning message will appear on the cluster, and the system will turn off automatically or the system will be limited. We recommend that the system be inspected by an authorized HYUNDAI dealer.

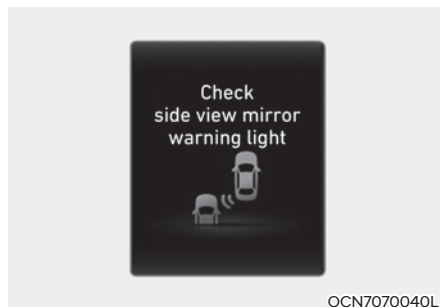

When the outside rearview mirror warning light is not working properly, the 'Check side view mirror warning light' warning message will appear on the cluster. We recommend that the system be inspected by an authorized HYUNDAI dealer.

### Function disabled

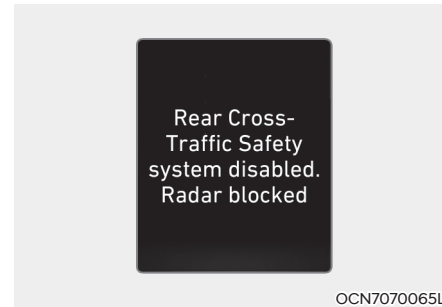

When the rear bumper around the rear-side radar or sensor is covered with foreign material, such as snow or rain, or installing a trailer or carrier, it can reduce the detecting performance and temporarily limit or disable Rear Cross-Traffic Safety system.

If this occurs, the 'Rear Cross-Traffic Safety system disabled. Radar blocked' warning message will appear on the cluster.

The system will operate normally when such foreign material or trailer, etc. is removed.

If the system does not operate normally after it is removed, we recommend that the system be inspected by an authorized HYUNDAI dealer.

**WARNING**

- Even though the warning message does not appear on the cluster, Rear Cross-Traffic Safety system may not operate properly.
- Rear Cross-Traffic Safety system may not operate properly in an area (for example: open terrain), where any substance are not detected after turning ON the engine.

**CAUTION**

Turn off Rear Cross-Traffic Safety system to install a trailer, carrier, etc., or remove the trailer, carrier, etc. to use Rear Cross-Traffic Safety system.

**Limitations of the function**

Rear Cross-Traffic Safety system may not operate normally, or the system may operate unexpectedly under the following circumstances:

- Departing from where trees or grass are overgrown
- Departing from where roads are wet
- Speed of the approaching vehicle is fast or slow

Braking control may not work, driver's attention is required in the following circumstances:

- The vehicle severely vibrates while driving over a bumpy road, uneven road or concrete patch
- Driving on a slippery surface due to snow, water puddle, ice, etc.
- The tire pressure is low or a tire is damaged
- The brake is reworked
- Remote Smart Parking Assist is operating (if equipped)

**CAUTION**

For more details on the limitations of the rear corner radar, refer to "Blind-Spot Collision-Avoidance Assist (BCA)" section in chapter 7.

**WARNING**

- Driving near a vehicle or structure

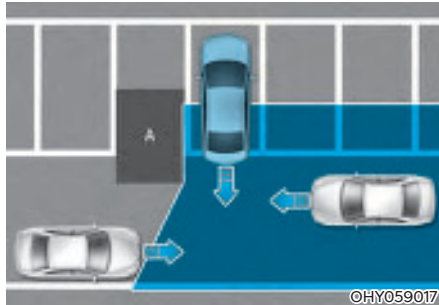

[A] : Structure

**Rear Cross-Traffic Safety system may be limited when driving near a vehicle or structure, and may not detect the vehicle approaching from the left or right. If this occurs, the system may not warn the driver or control the brakes when necessary.**

**Always check your surroundings while backing up.**

- When the vehicle is in a complex parking environment

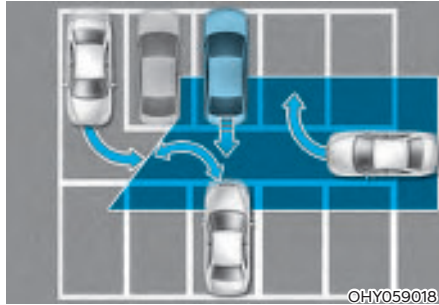

Rear Cross-Traffic Safety system may detect vehicles which are parking or pulling out near your vehicle (for example: a vehicle leaving beside your vehicle, a vehicle parking or pulling out in the rear area, a vehicle approaching your vehicle making a turn, etc.). If this occurs, the system may unnecessarily warn the driver and control the brake.

Always check your surroundings while backing up.

- When the vehicle is parked diagonally

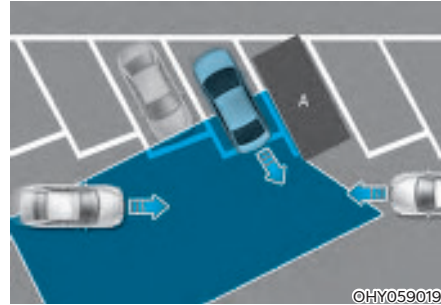

[A] : Vehicle

Rear Cross-Traffic Safety system may be limited when backing up diagonally, and may not detect the vehicle approaching from the left or right. If this occurs, the system may not warn the driver or control the brakes when necessary.

Always check your surroundings while backing up.

- When the vehicle is on or near a slope

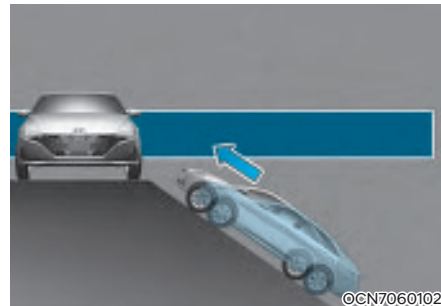

Rear Cross-Traffic Safety system may be limited when the vehicle is on a uphill or downhill slope, or near it, and may not detect the vehicle approaching from the left or right. If this occurs, the system may not warn the driver or control the brakes when necessary.

Always check your surroundings while backing up.

- Pulling into the parking space where there is a structure

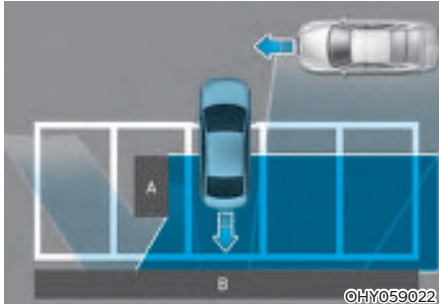

[A] : Structure, [B] :Wall

Rear Cross-Traffic Safety system may detect vehicles passing by in front of you when parking in reverse into a parking space with a wall or structure in the rear or side area. If this occurs, the system may unnecessarily warn the driver and control the brake.

Always check your surroundings while backing up.

- When the vehicle is parked rearward

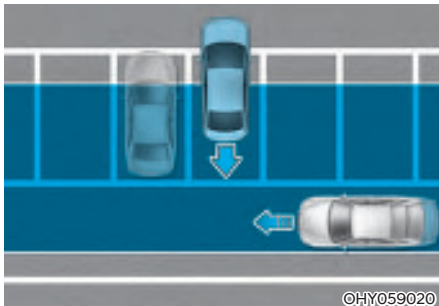

Rear Cross-Traffic Safety system may detect vehicles passing by behind you when parking in reverse into a parking space. If this occurs, the system may unnecessarily warn the driver and control the brake.

Always check your surroundings while backing up.

### WARNING

- When you are towing a trailer or another vehicle, we recommend that Rear Cross-Traffic Safety system is turned off due to safety reasons.
- Rear Cross-Traffic Safety system may not operate normally if interfered by strong electromagnetic waves.
- Rear Cross-Traffic Safety system may not operate for 15 seconds after the vehicle is started, or the rear corner radars are initialized.

### Information

This device complies with Part 15 of the FCC rules.

Operation is subject to the following three conditions:

1. This device may not cause harmful interference, and
2. This device must accept any interference received, including interference that may cause undesired operation.
3. Changes or modifications not expressly approved by the party responsible for compliance could void the user's authority to operate the device.

### Information

Radio frequency radiation exposure information:

This equipment complies with FCC radiation exposure limits set forth for an uncontrolled environment.

This equipment should be installed and operated with minimum distance of 8 in. (20 cm) between the radiator (antenna) and your body.

This transmitter must not be co-located or operating in conjunction with any other antenna or transmitter.

## REVERSE PARKING DISTANCE WARNING (PDW) (IF EQUIPPED)

Reverse Parking Distance Warning can warn the driver if an obstacle is detected when the vehicle is moving forward or backward at low speeds.

### ***Detecting sensor***



[2] : Rear ultrasonic sensors

Refer to the picture above for the detailed location of the detecting sensors.

### **System settings**

#### **Warning Volume**



With the Engine Start/Stop button in the ON position, select 'Driver Assistance → Warning Volume' from the Settings menu to change the Warning Volume to 'High', 'Medium' or 'Low' for Reverse Parking Distance Warning.

If you change the Warning Volume, the Warning Volume of other Driver Assistance systems may change.

### Function operation

#### Reverse Parking Distance Warning

- Reverse Parking Distance Warning will operate when the gear is in R (Reverse).
- Reverse Parking Distance Warning detects a person, animal or object in the rear when the vehicle's rearward speed is below 6 mph (10 km/h).

Distance from object	Warning indicator	
	Driving rearward	Warning sound
24-48 in. (60-120 cm)		Buzzer beeps intermittently
12-24 in. (30-60 cm)		Beeps more frequently
12 in. (within 30 cm)		Beeps continuously

- The corresponding indicator will illuminate whenever each ultrasonic sensor detects a person, animal or object in its sensing range. Also an audible warning will sound.
- When more than two objects are detected at the same time, the closest one will be warned with an audible warning.
- The shape of the indicator in the illustration may differ from the actual vehicle.

### Function malfunction and precautions

#### Function malfunction

After starting the engine, a beep will sound when the gear is shifted to R (Reverse) to indicate the system is operating normally.

However, if one or more of the following occurs, first check whether the ultrasonic sensor is damaged or whether the system is in a non operating condition. If it still does not work properly, we recommend that the system be inspected by an authorized HYUNDAI dealer.

- The audible warning does not sound.
- The buzzer sounds intermittently.
- The 'Parking sensor error or blockage' warning message appears on the cluster.

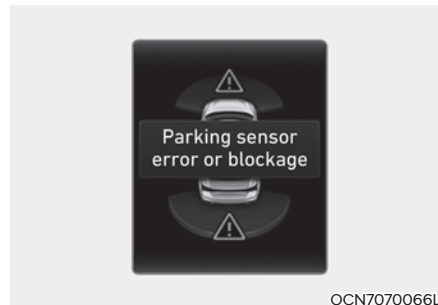



**WARNING**

- **Reverse Parking Distance Warning is a supplemental system. The operation of the system can be affected by several factors (including environmental conditions). It is the responsibility of the driver to always check the rear view before and while parking.**
- **Your new vehicle warranty does not cover any accidents or damage to the vehicle.**
- **Pay close attention when driving near objects, pedestrians, and especially children. Some objects may not be detected by the ultrasonic sensors, due to the objects distance, size or material, all of which can limit the effectiveness of the sensor.**

***Limitations of the system***

- Reverse Parking Distance Warning may not operate normally when:
  - Moisture is frozen to the sensor
  - Sensor is covered with foreign material, such as snow or water (The system will operate normally when such foreign material are removed.)
  - The weather is extremely hot or cold
  - The sensor or sensor assembly is disassembled
  - The surface of the sensor is pressed hard or an impact is applied with a hard object
  - The surface of the sensor is scratched with a sharp object
  - The sensors or its surrounding area is directly sprayed with high pressure washer
- Reverse Parking Distance Warning may malfunction when:
  - Heavy rain or water spray is present
  - Water flows on the surface of the sensor
  - Affected by another vehicle's sensors
  - The sensor is covered with snow
  - Driving on uneven road, gravel roads or bushes
  - Objects that generates ultrasonic waves are near the sensor
  - Installing the license plate differently from the original location
  - The vehicle bumper height or ultrasonic sensor installation has been modified
- The following objects may not be detected:
  - Sharp or slim objects, such as ropes, chains or small poles.
  - Objects, which tend to absorb sensor frequency, such as clothes, spongy material or snow.
  - Objects smaller than 40 in. (100 cm) in length and narrower than 6 in. (14 cm) in diameter.
- Parking Distance Warning Indicators may be displayed differently from the actual detected location when the obstacle is located between the sensors.
- Parking Distance Warning indicator may not occur sequentially depending on vehicle speed or obstacle shape.
- If Reverse Parking Distance Warning needs repair, we recommend that the system be inspected by an authorized HYUNDAI dealer.

## REVERSE PARKING COLLISION-AVOIDANCE ASSIST (PCA) (IF EQUIPPED)

Reverse Parking Collision-Avoidance Assist can warn the driver or can assist with braking to help reduce the possibility of collision with a pedestrian or an object when backing up.

### WARNING

- **ALWAYS** look around your vehicle to make sure there are no pedestrians or objects before moving the vehicle.
- Do not solely rely on the system. Doing so may lead to vehicle damage or injuries.
- Some objects may not be detected by the rear ultrasonic sensors due to the objects distance, size or material, all of which can limit the effectiveness of the sensor.

### Detecting sensor



- [1] : Rear view camera,  
[2] : Rear ultrasonic sensors

Refer to the picture above for the detailed location of the detecting sensors.



### CAUTION

Take the following precautions to maintain optimal performance of the detecting sensors:

- Always keep the rear view camera and rear ultrasonic sensors clean.
- Do not use any cleanser containing acid or alkaline detergents when cleaning the rear view camera lens. Use only a mild soap or neutral detergent, and rinse thoroughly with water.
- Never disassemble or strike the rear view camera or the rear ultrasonic sensors components.
- Do not apply unnecessary force on the rear view camera or the rear ultrasonic sensors. The system may not operate properly if the rear view camera or the rear ultrasonic sensor(s) is forcibly moved out of proper alignment. We recommend that the vehicle be inspected by an authorized HYUNDAI dealer.
- Do not spray the rear view camera or the rear ultrasonic sensors or their surrounding area directly with a high pressure washer. It may cause the rear view camera or the rear ultrasonic sensors to malfunction.
- The function may not work properly if the bumper has been damaged, replaced or repaired.
- Do not apply objects, such as a bumper sticker or a bumper guard, near the rear view camera or rear ultrasonic sensors or apply paint to the bumper. Doing so may adversely affect the performance of the function.
- Reverse Parking Collision-Avoidance Assist may not operate normally if interfered by strong electromagnetic waves.

## Function settings

### Setting

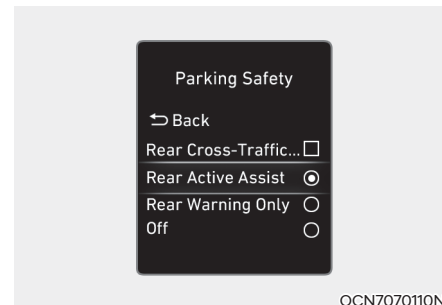

### Parking Safety

With the Engine Start/Stop button in the ON position, select or deselect 'Driver Assistance → Parking Safety' from the Settings menu to set whether or not to use each function.

- If 'Rear Active Assist' is selected, the function will warn the driver and assist with braking when a collision with a pedestrian or an object is imminent.
- If 'Rear Warning Only' is selected, the function will warn the driver when a collision with a pedestrian or an object is imminent. Braking will not be assisted.
- If 'Off' is selected, the function will turn off.



### Warning Timing

With the Engine Start/Stop button in the ON position, select 'Driver Assistance → Warning Timing' from the Settings menu to change the initial warning activation time for Reverse Parking Collision-Avoidance Assist.

When the vehicle is first delivered, Warning Timing is set to 'Normal'. If you change the Warning Timing, the warning time of other Driver Assistance systems may change.

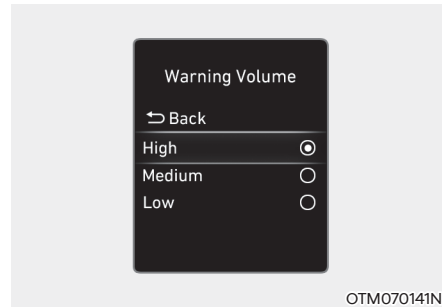

### Warning Volume

With the Engine Start/Stop button in the ON position, select 'Driver Assistance → Warning Volume' from the Settings menu to change the Warning Volume to 'High', 'Medium', 'Low' or 'Off' for Reverse Parking Collision-Avoidance Assist.

However, when Warning Volume is turned off, the steering wheel vibration function will turn on if it was turned off.

If you change the Warning Volume, the Warning Volume of other Driver Assistance systems may change.

## Function operation

### **Operating conditions**

If 'Active Assist' or 'Warning Only' is set from the Settings menu, Reverse Parking Collision-Avoidance Assist will be in the ready status when the following conditions are satisfied:

- The tailgate is closed
- The gear is shifted to R (Reverse)
- Vehicle speed is below 6 mph (10 km/h)
- System components such as the rear view camera and the rear ultrasonic sensors are in normal conditions

### **Warning Only**

- If the function detects a risk of collision with a pedestrian or an object, the system will warn the driver with an audible warning, steering wheel vibration and warning message on the cluster. When Rear View Monitor is operating, a warning will appear on the infotainment system screen.
- 'If 'Warning Only' is selected, braking will not be assisted.
- The warning will turn off when the gear is shifted to P (Park), N (Neutral) or D (Drive).

### **Active Assist**

- If the function detects a risk of collision with a pedestrian or an object, the system will warn the driver with an audible warning, steering wheel vibration and warning message on the cluster. When Rear View Monitor is operating, a warning will appear on the infotainment system screen.
- If the function detects imminent collision with a pedestrian or an object behind the vehicle, the system will assist you with braking. The driver needs to pay attention as the brake assist will end within 2 seconds. The driver must immediately depress the brake pedal and check vehicle surroundings.
- Brake control will end when:
  - The gear is shifted to P (Park) or D (Drive).
  - The driver depresses the brake pedal with sufficient power
  - Braking assist has last for approximately 2 seconds
- The warning will turn off when:
  - The driver shifts the gear to P (Park), N (Neutral), or D (Drive)
- The brake control may not operate properly depending on the status of ESC (Electronic Stability Control).  
There will only be a warning when:
  - The ESC (Electronic Stability Control) warning light is on
  - ESC (Electronic Stability Control) is engaged in a different function

 **WARNING**

- Reverse Parking Collision-Avoidance Assist may not operate properly or may operate unnecessarily depending on the road conditions and the surroundings.
- Always pay extreme caution while driving. The driver is responsible for controlling the brake for safe driving.
- Always pay attention to road and traffic conditions while driving, whether or not there is a warning.

 **CAUTION**

- Playing the vehicle audio system at high volume may prevent passengers from hearing Reverse Parking Collision-Avoidance Assist warning sounds.
- Noise may be heard when sudden braking occurs to avoid a collision.
- If any other warning sound such as the seat belt warning chime is already generated, Reverse Parking Collision-Avoidance Assist warning may not sound.
- The performance of Reverse Parking Collision-Avoidance Assist may vary under certain conditions. If vehicle speed is above 2 mph (4 km/h), the system will provide collision avoidance assist only when pedestrians are detected. Always look around and pay attention when backing up your vehicle.

 **Information**

The function can detect a pedestrian or an object when:

- A pedestrian is standing behind the vehicle
- A large obstacle, such as a vehicle, is parked in the rear center of your vehicle

**Function malfunction and limitations**

**Function malfunction**

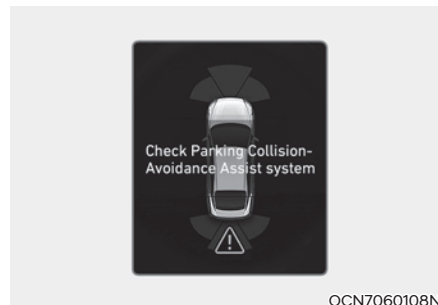

When Reverse Parking Collision-Avoidance Assist or other related function are not working properly, the 'Check Parking Collision-Avoidance Assist system' warning message will appear on the cluster, and the system will turn off automatically. We recommend that the function be inspected by an authorized HYUNDAI dealer.

**Function disabled**

OCN7050046

The rear view camera is used as a detecting sensor to detect pedestrians. If the camera lens is covered with foreign material, such as snow or rain, it may adversely affect camera performance and Reverse Parking Collision-Avoidance Assist may not operate normally. Always keep the camera lens clean.



OCN7060103

The rear ultrasonic sensors are located inside the rear bumper to detect objects in the rear area. If the sensors are covered with foreign material, such as snow or rain, it may adversely affect sensor performance and Reverse Parking Collision-Avoidance Assist may not operate normally. Always keep the rear bumper clean.

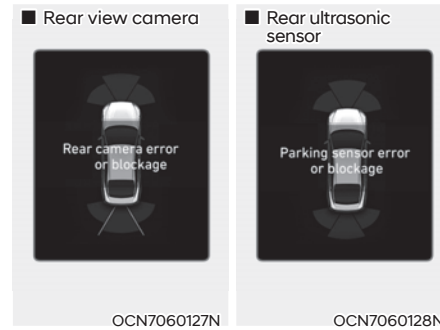

The 'Rear camera error or blockage' or 'Parking sensor error or blockage' warning message will appear on the cluster if the following situations occur:

- The rear view camera is covered with foreign material, such as snow or rain, etc.
- There is inclement weather, such as heavy snow, heavy rain, etc.

If this occurs, Reverse Parking Collision-Avoidance Assist may turn off or may not operate properly. Check whether the rear view camera and rear ultrasonic sensors are clean.

### **Limitations of the function**

Reverse Parking Collision-Avoidance Assist may not assist braking or warn the driver even if there are pedestrians or objects under the following circumstances:

- Any non-factory equipment or accessory is installed
- Your vehicle is unstable due to an accident or other causes
- Bumper height or rear ultrasonic sensor installation has been modified
- Rear view camera or rear ultrasonic sensor(s) is damaged
- Rear view camera or the rear ultrasonic sensor(s) is stained with foreign material, such as snow, dirt, etc.
- Rear view camera is obscured by a light source or by inclement weather, such as heavy rain, fog, snow, etc.
- The surrounding is very bright or very dark
- Outside temperature is very high or very low
- The wind is either strong (above 12 mph (20 km/h)) or blowing perpendicular to the rear bumper
- Objects generating excessive noise, such as vehicle horns, loud motorcycle engines or truck air brakes, are near your vehicle
- An ultrasonic sensor with similar frequency is near your vehicle
- There is ground height difference between the vehicle and the pedestrian
- The image of the pedestrian in the rear view camera is indistinguishable from the background
- The pedestrian is near the rear edge of the vehicle
- The pedestrian is not standing upright
- The pedestrian is either very short or very tall for the system to detect
- The pedestrian or cyclist is wearing clothing that easily blends into the background, making it difficult to detect
- The pedestrian is wearing clothing that does not reflect ultrasonic waves well
- Size, thickness, height, or shape of the object does not reflect ultrasonic waves well (e.g., pole, bush, curbs, carts, edge of a wall, etc.)
- The pedestrian or the object is moving
- The pedestrian or the object is very close to the rear of the vehicle
- A wall is behind the pedestrian or the object
- The object is not located at the rear center of your vehicle
- The object is not parallel to the rear bumper
- The road is slippery or inclined
- The driver backs up the vehicle immediately after shifting to R (Reverse)
- The driver accelerates or circles the vehicle



Reverse Parking Collision-Avoidance Assist may unnecessarily warn the driver or assist with braking even if there are no pedestrians or objects under the following circumstances:

- Any non-factory equipment or accessory is installed
- Your vehicle is unstable due to an accident or other causes
- Bumper height or rear ultrasonic sensor installation has been modified
- Your vehicle height is low or high due to heavy loads, abnormal tire pressure, etc.
- Rear view camera or the rear ultrasonic sensor(s) is stained with foreign material, such as snow, dirt, etc.
- The pattern on the road is mistaken for a pedestrian
- There is shadow or light reflecting on the ground
- Pedestrians or objects are around the path of the vehicle
- Objects generating excessive noise, such as vehicle horns, loud motorcycle engines or truck air brakes, are near your vehicle
- Your vehicle is backing towards a narrow passage or parking space
- Your vehicle is backing towards an uneven road surface, such as an unpaved road, gravel, bump, gradient, etc.
- A trailer or carrier is installed on the rear of your vehicle
- An ultrasonic sensor with similar frequency is near your vehicle

### DECLARATION OF CONFORMITY (IF EQUIPPED)

The radio frequency components (Rear Corner Radar) complies:

**- For USA**



The antenna(s) must be installed such that a minimum separation distance of at least 20 cm is maintained between the radiator (antenna) and all persons at all times. This device must not be co-located or operating in conjunction with any other antenna or transmitter.

OANATEL124

**- For Canada**

This device complies with Innovation, Science and Economic Development Canada's licence-exempt RSS standard(s). Operation is subject to the following two conditions:  
(1) this device may not cause interference, and  
(2) this device must accept any interference, including interference that may cause undesired operation of the device.  
Le présent appareil est conforme aux CNR d'Industrie Canada applicables aux appareils radio exempts de licence. L'exploitation est autorisée aux deux conditions suivantes:  
(1) l'appareil ne doit pas produire de brouillage,  
et  
(2) l'utilisateur de l'appareil doit accepter tout brouillage radioélectrique subi, même si le brouillage est susceptible d'en compromettre le fonctionnement.

OANATEL124

## 8. Emergency Situations

---

Hazard Warning Flasher .....	8-2
In Case of an Emergency While Driving .....	8-2
If the Engine Stalls While Driving .....	8-2
If the Engine Stalls at a Crossroad or Crossing .....	8-2
If you Have a Flat Tire While Driving .....	8-3
If the Engine Will not Start .....	8-3
If the Engine Doesn't Turn Over or Turns Over Slowly .....	8-3
If the Engine Turns Over Normally but Doesn't Start .....	8-3
Jump Starting .....	8-4
If the engine overheats .....	8-6
Tire Pressure Monitoring System (TPMS) .....	8-8
Check tire pressure .....	8-8
Tire pressure monitoring system .....	8-9
Low tire pressure telltale .....	8-10
Low tire pressure position and tire pressure telltale .....	8-10
TPMS (Tire Pressure Monitoring System) malfunction indicator .....	8-12
Changing a tire with TPMS .....	8-12
If you Have a Flat Tire (With spare tire) .....	8-14
Jack and Tools .....	8-14
Changing Tires .....	8-15
Towing .....	8-20
Towing Service .....	8-20
Emergency Towing .....	8-21
Removable towing hook .....	8-21
Emergency towing .....	8-22

## HAZARD WARNING FLASHER

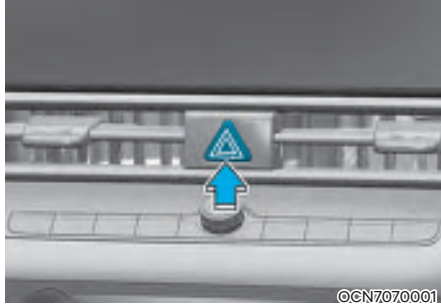

The hazard warning flasher serves as a warning to other drivers to exercise extreme caution when approaching, overtaking, or passing your vehicle.

It should be used whenever emergency repairs are being made or when the vehicle is stopped near the edge of a roadway.

To turn the hazard warning flasher on or off, press the hazard warning flasher button. The button is located in the center fascia panel. Both the left and right turn signal lights will flash simultaneously.

- The hazard warning flasher operates whether your vehicle is running or not.
- The turn signals do not work when the hazard flasher is on.

## IN CASE OF AN EMERGENCY WHILE DRIVING

### If the Engine Stalls While Driving

- Reduce your speed gradually, keeping a straight line. Move cautiously off the road to a safe place.
- Turn on your hazard warning flasher.
- Try to start the engine again. If your vehicle will not start, contact an authorized HYUNDAI dealer or seek other qualified assistance.

### If the Engine Stalls at a Crossroad or Crossing

If the engine stalls at a crossroads or crossing, if safe to do so, move the shift button to the N (Neutral) position and then push the vehicle to a safe location.

### If you Have a Flat Tire While Driving

If a tire goes flat while you are driving:

- Take your foot off the accelerator pedal and let the vehicle slow down while driving straight ahead. Do not apply the brakes immediately or attempt to pull off the road as this may cause loss of vehicle control resulting in an accident. When the vehicle has slowed to such a speed that it is safe to do so, brake carefully and pull off the road. Drive off the road as far as possible and park on firm, level ground. If you are on a divided highway, do not park in the median area between the two traffic lanes.
- When the vehicle is stopped, press the hazard warning flasher button, move the shift button into P (Park), and apply the parking brake, and place the ignition switch in the LOCK/OFF position.
- Have all passengers get out of the vehicle. Be sure they all get out on the side of the vehicle that is away from traffic.
- When changing a flat tire, follow the instructions provided later in this chapter.

### IF THE ENGINE WILL NOT START

#### If the Engine Doesn't Turn Over or Turns Over Slowly

- Be sure the shift button is in N (Neutral) or P (Park). The engine starts only when the shift button is in N (Neutral) or P (Park).
- Check the battery connections to be sure they are clean and tight.
- Turn on the interior light. If the light dims or goes out when you operate the starter, the battery is drained.

Do not push or pull the vehicle to start it. This could cause damage to your vehicle. See instructions for "Jump Starting" provided in this chapter.



#### CAUTION

**Push or pull starting the vehicle may cause the catalytic converter to overload which can lead to damage to the emission control system.**

#### If the Engine Turns Over Normally but Doesn't Start

Check the fuel level and add fuel if necessary.

If the engine still does not start, have your vehicle checked by an authorized HYUNDAI dealer.

## JUMP STARTING

Jump starting can be dangerous if done incorrectly. Follow the jump starting procedure in this section to avoid serious injury or damage to your vehicle. If in doubt about how to properly jump start your vehicle, we strongly recommend that you have a service technician or towing service do it for you.



### WARNING

To prevent **SERIOUS INJURY** or **DEATH** to you or bystanders, always follow these precautions when working near or handling the battery:



Always read and follow instructions carefully when handling a battery.



Wear eye protection designed to protect the eyes from acid splashes.



Keep all flames, sparks, or smoking materials away from the battery.



Hydrogen is always present in battery cells, is highly combustible, and may explode if ignited.



Keep batteries out of reach of children.



Batteries contain sulfuric acid which is highly corrosive. Do not allow acid to contact your eyes, skin or clothing.

**If acid gets into your eyes, flush your eyes with clean water for at least 15 minutes and get immediate medical attention. If acid gets on your skin, thoroughly wash the area. If you feel pain or a burning sensation, get medical attention immediately.**

- When lifting a plastic-cased battery, excessive pressure on the case may cause battery acid to leak. Lift with a battery carrier or with your hands on opposite corners.
- Do not attempt to jump start your vehicle if your battery is frozen.
- NEVER attempt to recharge the battery when the vehicle's battery cables are connected to the battery.
- The electrical ignition system works with high voltage. NEVER touch these components with the engine running or when the ignition switch is in the ON position.



### Information



An inappropriately disposed battery can be harmful to the environment and human health. Dispose of the battery according to your local law(s) or regulations.

### NOTICE

To prevent damage to your vehicle:

- Only use a 12-volt power supply (battery or jumper system) to jump start your vehicle.
- Do not attempt to jump start your vehicle by push-starting.

### ***Jump starting procedure***

1. Position the vehicles close enough that the jumper cables will reach, but do not allow the vehicles to touch.
2. Avoid fans or any moving parts in the engine compartment at all times, even when the vehicles are turned off.
3. Turn off all electrical devices such as radios, lights, air conditioning, etc. Put the vehicle in P (Park), and set the parking brakes. Turn both vehicles OFF.

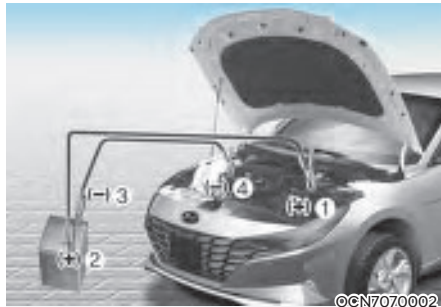

4. Connect the jumper cables in the exact sequence shown in the illustration. First connect one jumper cable to the red, positive (+) jumper terminal of your vehicle (1).
5. Connect the other end of the jumper cable to the red, positive (+) battery/ jumper terminal of the assisting vehicle (2).
6. Connect the second jumper cable to the black, negative (-) battery/ chassis ground of the assisting vehicle (3).

7. Connect the other end of the second jumper cable to the black, negative (-) chassis ground of your vehicle (4).
8. Do not allow the jumper cables to contact anything except the correct battery or jumper terminals or the correct ground. Do not lean over the battery when making connections.
9. Operate your vehicle for at least 30 minutes of driving or at least 60 minutes of engine running at idle before shutting off the engine. Without sufficient time to charge the battery the vehicle will reoccur another no start. You can also visit your nearest dealer to request the battery be charged and tested.

If your vehicle will not start after a few attempts, it probably requires servicing. In this event please seek qualified assistance. If the cause of your battery discharging is not apparent, have your vehicle checked by an authorized HYUNDAI dealer.

Disconnect the jumper cables in the exact reverse order you connected them:

1. Disconnect the jumper cable from the black, negative (-) chassis ground of your vehicle (4).
2. Disconnect the other end of the jumper cable from the black, negative (-) battery/chassis ground of the assisting vehicle (3).
3. Disconnect the second jumper cable from the red, positive (+) battery/ jumper terminal of the assisting vehicle (2).
4. Disconnect the other end of the jumper cable from the red, positive (+) jumper terminal of your vehicle (1).

## IF THE ENGINE OVERHEATS

If your temperature gauge indicates overheating, you experience a loss of power, or hear loud pinging or knocking, the engine may be overheating. If this happens, you should:

1. Pull off the road and stop as soon as it is safe to do so.
2. Put the vehicle in P (Park), and set the parking brake. If the air conditioning is ON, turn it OFF.
3. If engine coolant is running out under the vehicle or steam is coming out from the hood, stop the engine. Do not open the hood until the coolant has stopped running or the steaming has stopped. If there is no visible loss of engine coolant and no steam, leave the engine running and check to be sure the engine cooling fan is operating. If the fan is not running, turn the engine off.



### WARNING



While the engine is running, keep hands, clothing and tools away from the moving parts such as the cooling fan and drive belt to prevent serious injury.



4. Check to see if the water pump drive belt is missing.
  - (1) If it is not missing, check to see that it is tight.
  - (2) If the drive belt seems to be satisfactory, check for coolant leaking from the radiator, hoses or under the vehicle. (If the air conditioning had been in use, it is normal for cold water to be draining from it when you stop.)
5. If the water pump drive belt is broken or engine coolant is leaking out, stop the engine immediately and we recommend that you call an authorized HYUNDAI dealer for assistance.



### WARNING



**NEVER** remove the radiator cap or the drain plug while the engine and radiator are hot. Hot coolant and steam may blow out under pressure, causing serious injury.

Turn the engine off and wait until the engine cools down. Use extreme care when removing the radiator cap. Wrap a thick towel around it, and turn it counterclockwise slowly to the first stop. Step back while the pressure is released from the cooling system. When you are sure all the pressure has been released, press down on the cap, using a thick towel, and continue turning counterclockwise to remove it.



6. If you cannot find the cause of the overheating, wait until the engine temperature has returned to normal. Then, if coolant has been lost, carefully add coolant to the reservoir to bring the fluid level in the reservoir up to the halfway mark.
7. Proceed with caution, keeping alert for further signs of overheating. If overheating happens again, we recommend that you call an authorized HYUNDAI dealer for assistance.

**NOTICE**

- **Serious loss of coolant indicates a leak in the cooling system and we recommend the system be checked by an authorized HYUNDAI dealer.**
- **When the engine overheats from low engine coolant, suddenly adding engine coolant may cause cracks in the engine. To prevent damage, add engine coolant slowly in small quantities.**

## TIRE PRESSURE MONITORING SYSTEM (TPMS)



- (1) Low Tire Pressure Telltale/TPMS Malfunction Indicator
- (2) Low Tire Pressure Position Telltale and Tire Pressure Telltale (Shown on the LCD display)

### Check tire pressure



- You can check the tire pressure in the Assist mode on the cluster.
- **Refer to the “LCD Display Modes” in chapter 4.**
- Tire pressure is displayed after a few minutes of driving after initial engine start up.
- If tire pressure is not displayed when the vehicle is stopped, “Drive to display” message will appear. After driving, check the tire pressure.
- The displayed tire pressure values may differ from those measured with a tire pressure gauge.
- You can change the tire pressure unit in the User Settings Mode on the cluster.
  - psi, kpa, bar (**Refer to the “User Settings Mode” section in chapter 4.**)

## Tire pressure monitoring system



### WARNING

**Over-inflation or under-inflation can reduce tire life, adversely affect vehicle handling, and lead to sudden tire failure that may cause loss of vehicle control resulting in an accident.**

Each tire, including the spare (if provided), should be checked monthly when cold and inflated to the inflation pressure recommended by the vehicle manufacturer on the vehicle placard or tire inflation pressure label. (If your vehicle has tires of a different size than the size indicated on the vehicle placard or tire inflation pressure label, you should determine the proper tire inflation pressure for those tires.)

As an added safety feature, your vehicle has been equipped with a tire pressure monitoring system (TPMS) that illuminates a low tire pressure telltale when one or more of your tires is significantly under-inflated. Accordingly, when the low tire pressure telltale illuminates, you should stop and check your tires as soon as possible, and inflate them to the proper pressure. Driving on a significantly underinflated tire causes the tire to overheat and can lead to tire failure.

Under-inflation also reduces fuel efficiency and tire tread life, and may affect the vehicle's handling and stopping ability.

Please note that the TPMS is not a substitute for proper tire maintenance, and it is the driver's responsibility to maintain correct tire pressure, even if under-inflation has not reached the level to trigger illumination of the TPMS low tire pressure telltale.

Your vehicle has also been equipped with a TPMS malfunction indicator to indicate when the system is not operating properly. The TPMS malfunction indicator is combined with the low tire pressure telltale. When the system detects a malfunction, the telltale will flash for approximately one minute and then remain continuously illuminated. This sequence will continue upon subsequent vehicle start-ups as long as the malfunction exists.

When the malfunction indicator is illuminated, the system may not be able to detect or signal low tire pressure as intended. TPMS malfunctions may occur for a variety of reasons, including the installation of replacement or alternate tires or wheels on the vehicle that prevent the TPMS from functioning properly.

Always check the TPMS malfunction telltale after replacing one or more tires or wheels on your vehicle to ensure that the replacement or alternate tires and wheels allow the TPMS to continue to function properly.

**NOTICE**

If any of the below happens, have the system checked by an authorized HYUNDAI dealer.

1. The Low Tire Pressure Telltale/ TPMS Malfunction Indicator does not illuminate for 3 seconds when the ignition switch is placed to the ON position or engine is running.
2. The TPMS Malfunction Indicator remains illuminated after blinking for approximately 1 minute.
3. The Low Tire Pressure Position Telltale remains illuminated.



**Low tire pressure telltale**

**Low tire pressure position and tire pressure telltale**



When the tire pressure monitoring system warning indicators are illuminated and a warning message displayed on the cluster LCD display, one or more of your tires is significantly under-inflated. The Low Tire Pressure Position Telltale will indicate which tire is significantly underinflated by illuminating the corresponding position light.

If either telltale illuminates, immediately reduce your speed, avoid hard cornering and anticipate increased stopping distances. You should stop and check your tires as soon as possible. Inflate the tires to the proper pressure as indicated on the vehicle's placard or tire inflation pressure label located on the driver's side center pillar outer panel.

If you cannot reach a service station or if the tire cannot hold the newly added air, replace the low pressure tire with the spare tire.

The Low Tire Pressure Telltale will remain on and the TPMS Malfunction Indicator may blink for one minute and then remain illuminated (when the vehicle is driven approximately 10 minutes at speed above 15.5 mph (25km/h)) until you have the low pressure tire repaired and replaced on the vehicle.

### Information

**The spare tire is not equipped with a tire pressure sensor.**



### CAUTION

**In winter or cold weather, the Low Tire Pressure Telltale may be illuminated if the tire pressure was adjusted to the recommended tire inflation pressure in warm weather. It does not mean your TPMS is malfunctioning because the decreased temperature leads to a proportional lowering of tire pressure.**

**When you drive your vehicle from a warm area to a cold area or from a cold area to a warm area, or the outside temperature is greatly higher or lower, you should check the tire inflation pressure and adjust the tires to the recommended tire inflation pressure.**



### WARNING

**Low pressure damage**

**Significantly low tire pressure makes the vehicle unstable and can contribute to loss of vehicle control and increased braking distances.**

**Continued driving on low pressure tires can cause the tires to overheat and fail.**



### TPMS (Tire Pressure Monitoring System) malfunction indicator

The TPMS Malfunction Indicator will illuminate after it blinks for approximately one minute when there is a problem with the Tire Pressure Monitoring System.

We recommend that the system be checked by an authorized HYUNDAI dealer.

#### **NOTICE**

**If there is a malfunction with the TPMS, the Low Tire Pressure Position Telltale will not be displayed even though the vehicle has an under-inflated tire.**

#### **NOTICE**

**The TPMS Malfunction Indicator may illuminate after blinking for one minute if the vehicle is near electric power supply cables or radio transmitters such as police stations, government and public offices, broadcasting stations, military installations, airports, transmitting towers, etc.**

**Additionally, the TPMS Malfunction Indicator may illuminate if snow chains are used or electronic devices such as computers, chargers, remote starters, navigation, etc. This may interfere with normal operation of the TPMS.**

### Changing a tire with TPMS

If you have a flat tire, the Low Tire Pressure and Position telltales will come on. We recommend that the flat tire be repaired by an authorized HYUNDAI dealer as soon as possible or replace the flat tire with the spare tire.

#### **NOTICE**

**It is recommended that you do not use a puncture-repairing agent not approved by a HYUNDAI dealer to repair and/or inflate a low pressure tire. Tire sealant not approved by a HYUNDAI dealer may damage the tire pressure sensor.**

The spare tire (if equipped) does not come with a tire pressure monitoring sensor. When the low pressure tire or the flat tire is replaced with the spare tire, the Low Tire Pressure Telltale will remain on. Also, the TPMS Malfunction Indicator will illuminate after blinking for one minute if the vehicle is driven at speed above 15.5 mph (25km/h) for approximately 10 minutes.

Once the original tire equipped with a tire pressure monitoring sensor is reinflated to the recommended pressure and reinstalled on the vehicle, the Low Tire Pressure Telltale and TPMS Malfunction Indicator will go off within a few minutes of driving.

If the indicators do not extinguish after a few minutes, please visit an authorized HYUNDAI dealer.

Each wheel is equipped with a tire pressure sensor mounted inside the tire behind the valve stem (except for the spare tire). You must use TPMS specific wheels. It is recommended that you always have your tires serviced by an authorized HYUNDAI dealer.

You may not be able to identify a tire with low pressure by simply looking at it. Always use a good quality tire pressure gauge to measure the tire's inflation pressure. Please note that a tire that is hot (from being driven) will have a higher pressure measurement than a tire that is cold.

A cold tire means the vehicle has been sitting for 3 hours and driven for less than 1 mile (1.6 km) in that 3 hour period.

Allow the tire to cool before measuring the inflation pressure. Always be sure the tire is cold before inflating to the recommended pressure.



### WARNING

- **The TPMS cannot alert you to severe and sudden tire damage caused by external factors such as nails or road debris.**
- **If you feel any vehicle instability, immediately take your foot off the accelerator, apply the brakes gradually with light force, and slowly move to a safe position off the road.**



### WARNING

**Tampering with, modifying, or disabling the Tire Pressure Monitoring System (TPMS) components may interfere with the system's ability to warn the driver of low tire pressure conditions and/or TPMS malfunctions. Tampering with, modifying, or disabling the Tire Pressure Monitoring System (TPMS) components may void the warranty for that portion of the vehicle.**



### Information

**This device complies with Part 15 of the FCC rules.**

**Operation is subject to the following three conditions:**

- 1. This device may not cause harmful interference.**
- 2. This device must accept any interference received, including interference that may cause undesired operation.**
- 3. Changes or modifications not expressly approved by the party responsible for compliance could void the user's authority to operate the equipment.**

## IF YOU HAVE A FLAT TIRE (WITH SPARE TIRE)

### WARNING

Changing a tire can be dangerous. Follow the instructions in this section when changing a tire to reduce the risk of serious injury or death.

### CAUTION

Be careful as you use the jack handle to stay clear of the flat end. The flat end has sharp edges that could cause cuts.

### Jack and Tools

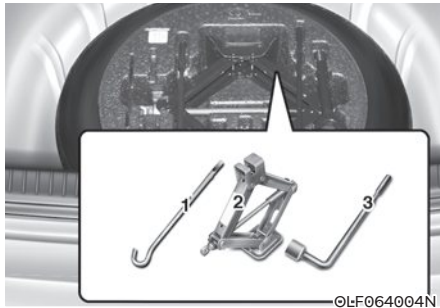

- (1) Jack handle
- (2) Jack
- (3) Wheel lug nut wrench

The jack, jack handle, and wheel lug nut wrench are stored in the luggage compartment under the luggage box cover.

The jack is provided for emergency tire changing only.

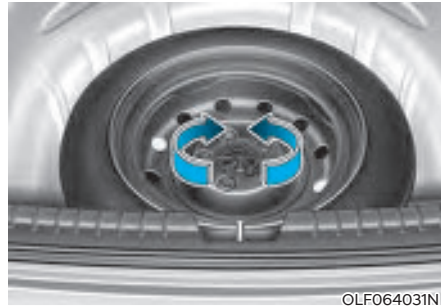

OLF064031N

Turn the winged hold down bolt counterclockwise to remove the spare tire.

Store the spare tire in the same compartment by turning the winged hold down bolt clockwise.

To prevent the spare tire and tools from “rattling”, store them in their proper location.

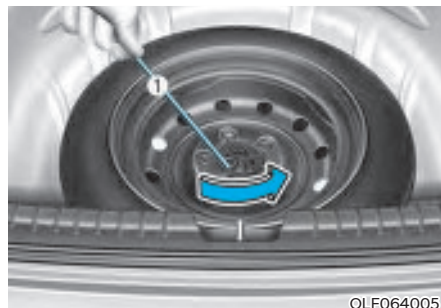

OLF064005

If it is hard to loosen the tire hold-down wing bolt by hand, you can loosen it easily using the jack handle.

1. Put the jack handle (1) inside of the tire hold-down wing bolt.
2. Turn the tire hold-down wing bolt counterclockwise with the jack handle.



## Changing Tires



### WARNING

A vehicle can slip or roll off of a jack causing serious injury or death to you or those nearby. Take the following safety precautions:

- Never place any portion of your body under a vehicle that is supported by a jack.
- NEVER attempt to change a tire in the lane of traffic. ALWAYS move the vehicle completely off the road on level, firm ground away from traffic before trying to change a tire. If you cannot find a level, firm place off the road, call a towing service for assistance.
- Be sure to use the jack provided with the vehicle.
- ALWAYS place the jack on the designated jacking positions on the vehicle and NEVER on the bumpers or any other part of the vehicle for jacking support.
- Do not start or run the engine while the vehicle is on the jack.
- Do not allow anyone to remain in the vehicle while it is on the jack.
- Keep children away from the road and the vehicle.

Follow these steps to change your vehicle's tire:

1. Park on a level, firm surface.
2. Shift the shift button into P (Park).
3. Press the hazard warning flasher button.
4. Remove the wheel lug nut wrench, jack, jack handle, and spare tire from the vehicle.



[A] : Block

5. Block both the front and rear of the tire diagonally opposite of the tire you are changing.



6. Loosen the wheel lug nuts counterclockwise one turn each in the order shown above, but do not remove any lug nuts until the tire has been raised off of the ground.

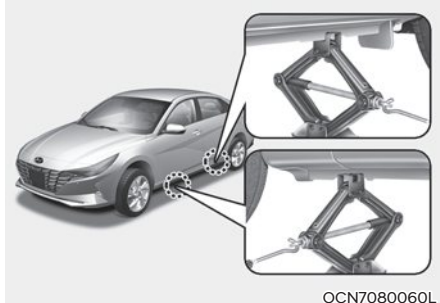

7. Place the jack at the designated jacking position under the frame closest to the tire you are changing. The jacking positions are plates welded to the frame with two notches. Never jack at any other position or part of the vehicle. Doing so may damage the side sill molding or other parts of the vehicle.

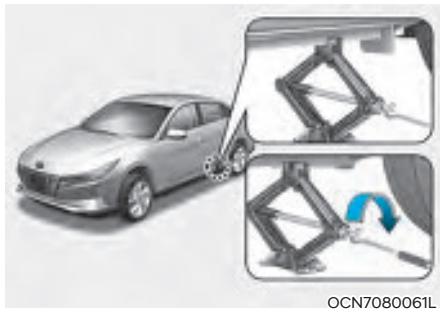

8. Insert the jack handle into the jack and turn it clockwise, raising the vehicle until the tire clears the ground. Make sure the vehicle is stable on the jack.
9. Loosen the lug nuts with the wheel lug nut wrench and remove them with your fingers. Remove the wheel from the studs and lay it flat on the ground out of the way. Remove any dirt or debris from the studs, mounting surfaces, and wheel.
10. Install the spare tire onto the studs of the hub.

11. Tighten the lug nuts with your fingers onto the studs with the smaller end of the lug nuts closest to the wheel.
12. Lower the vehicle to the ground by turning the jack handle counterclockwise.



13. Use the wheel lug nut wrench to tighten the lug nuts in the order shown. Double-check each lug nut until they are tight. After changing tires, have an authorized HYUNDAI dealer tighten the lug nuts to their proper torque as soon as possible. **The wheel lug nut should be tightened to 79~94 lbf·ft (11~13 kgf·m).**

If you have a tire gauge, check the tire pressure (see “Tires and Wheels” in chapter 2 for tire pressure instructions.). If the pressure is lower or higher than recommended, drive slowly to the nearest service station and adjust it to the recommended pressure. Always reinstall the valve cap after checking or adjusting tire pressure. If the cap is not replaced, air may leak from the tire. If you lose a valve cap, buy another and install it as soon as possible. After changing tires, secure the flat tire and return the jack and tools to their proper storage locations. If it is hard to secure the flat tire, put the flat tire in the luggage compartment.

**NOTICE**

- **Check the tire pressure as soon as possible after installing a spare tire. Adjust it to the recommended pressure.**
- **Check and tighten the wheel lug nuts after driving over 30 miles (50 km), after the spare tire is installed. Recheck the tire wheel lug nuts after driving over 620 miles (1,000 km) after the replaced tire is reinstalled.**

**CAUTION**

**Your vehicle has metric threads on the studs and lug nuts. Make certain during tire changing that the same nuts that were removed are reinstalled. If you have to replace your lug nuts make sure they have metric threads to avoid damaging the studs and ensure the wheel is properly secured to the hub. Consult an authorized HYUNDAI dealer for assistance.**

If any of the equipment such as the jack, lug nuts, studs, or other equipment is damaged or in poor condition, do not attempt to change the tire and call for assistance.

**Use of compact spare tires (if equipped)**

Compact spare tires are designed for emergency use only. Drive carefully on the compact spare tire and always follow the safety precautions.

**WARNING**

**To prevent compact spare tire failure and loss of control possibly resulting in an accident:**

- **Use the compact spare tire only in an emergency.**
- **NEVER operate your vehicle over 50 mph (80 km/h).**
- **Do not exceed the vehicle's maximum load rating or the load carrying capacity shown on the sidewall of the compact spare tire.**
- **Do not use the compact spare tire continuously. Repair or replace the original tire as soon as possible to avoid failure of the compact spare tire.**

When driving with the compact spare tire mounted to your vehicle:

- Check the tire pressure after installing the compact spare tire. The compact spare tire should be inflated to 60 psi (420 kPa).
- Do not take this vehicle through an automatic car wash while the compact spare tire is installed.
- Do not use the compact spare tire on any other vehicle because this tire has been designed especially for your vehicle.
- The compact spare tire's tread life is shorter than a regular tire. Inspect your compact spare tire regularly and replace worn compact spare tires with the same size and design, mounted on the same wheel.
- Do not use more than one compact spare tire at a time.

### **NOTICE**

**When the original tire and wheel are repaired and reinstalled on the vehicle, the lug nut torque must be set correctly. The correct lug nut tightening torque is 79~94 lbf-ft (11~13 kgf-m).**



### **CAUTION**

**To prevent damaging the compact spare tire and your vehicle:**

- **Drive slowly enough for the road conditions to avoid all hazards, such as a potholes or debris.**
- **Avoid driving over obstacles. The compact spare tire diameter is smaller than the diameter of a conventional tire and reduces the ground clearance approximately 1 inch (25 mm).**
- **Do not use tire chains on the compact spare tire. Because of the smaller size, a tire chain will not fit properly.**
- **Do not use the compact spare tire on any other wheels, nor should standard tires, snow tires, wheel covers or trim rings be used with the compact spare wheel.**

## Jack label

### ■ Example

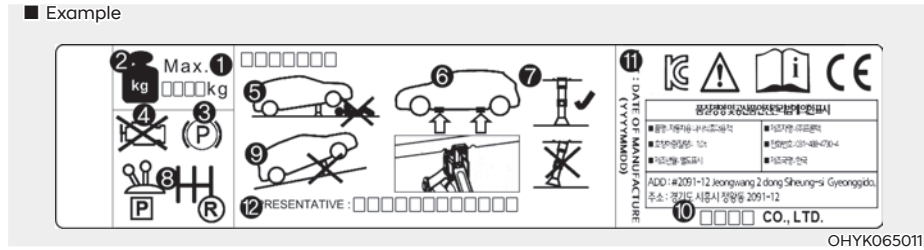

The actual Jack label in the vehicle may differ from the illustration.

**For more detailed specifications, refer to the label attached to the jack.**

1. Model Name
2. Maximum allowable load
3. When using the jack, set your parking brake.
4. When using the jack, stop the engine.
5. Do not get under a vehicle that is supported by a jack.
6. The designated locations under the frame
7. When supporting the vehicle, the base plate of jack must be vertical under the lifting point.
8. Shift into Reverse gear on vehicles with manual transmission or move the shift button to the P (Park) position on vehicles with automatic transmission.
9. The jack should be used on firm level ground.
10. Jack manufacture
11. Production date
12. Representative company and address

## TOWING

### Towing Service

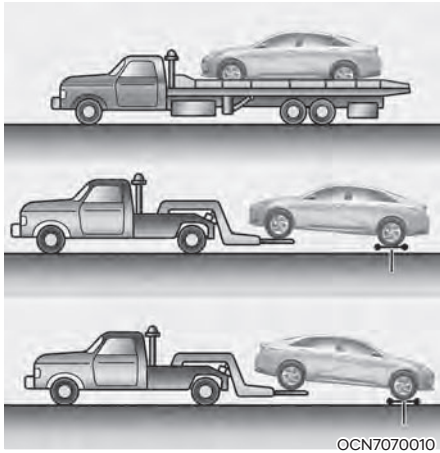

If emergency towing is necessary, we recommend having it done by an authorized HYUNDAI dealer or a commercial tow-truck service.

Proper lifting and towing procedures are necessary to prevent damage to the vehicle. The use of wheel dollies or flatbed is recommended.

It is acceptable to tow the vehicle with the rear wheels on the ground (without dollies) and the front wheels off the ground.

If any of the loaded wheels or suspension components are damaged or the vehicle is being towed with the front wheels on the ground, use a towing dolly under the front wheels.

When being towed by a commercial tow truck and wheel dollies are not used, the front of the vehicle should always be lifted, not the rear.

### ⚠ CAUTION

- Do not tow the vehicle with the front wheels on the ground as this may cause damage to the vehicle.



- Do not tow with sling-type equipment. Use a wheel lift or flatbed equipment.



- Do not tow the vehicle with four wheels in contact with the ground if it is the vehicle equipped with IVT. Otherwise, the transmission will be seriously damaged. Also, make sure not to tow the vehicle connecting it with other vehicles including camper vans.

### WARNING

If your vehicle is equipped with a rollover sensor, place the ignition switch in the LOCK/OFF or ACC position when the vehicle is being towed. The side impact and curtain air bag may deploy if the sensor detects the situation as a rollover.



When towing your vehicle in an emergency without wheel dollies:

1. Place the ignition switch in the ACC position.
2. Place the shift button in N (Neutral).
3. Release the parking brake.

### CAUTION

Failure to place the shift button in N (Neutral) when being towed with the front wheels on the ground can cause internal damage to the transmission.

### Emergency Towing

If towing is necessary, we recommend you have it done by an authorized HYUNDAI dealer or a commercial tow truck service.

### Removable towing hook



1. Open the trunk, and remove the towing hook from the tool case.



2. Remove the hole cover by pressing the lower part of the cover on the bumper.
3. Install the towing hook by turning it clockwise into the hole until it is fully secured.
4. Remove the towing hook and install the cover after use.

### Emergency towing

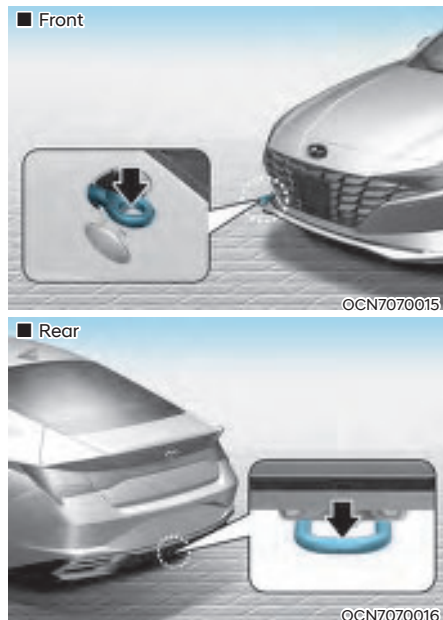

If towing is necessary, we recommend you have it done by an authorized HYUNDAI dealer or a commercial tow truck service.

If towing service is not available in an emergency, your vehicle may be temporarily towed using a cable or chain secured to the emergency towing hook at the front (or rear) of the vehicle.

Use extreme caution when towing the vehicle with a cable or chain. A driver must be in the vehicle to steer it and operate the brakes.

Towing in this manner may be done only on hard-surfaced roads for a short distance and at low speeds. Also, the wheels, axles, power train, steering and brakes must all be in good condition.

### CAUTION

**The driver must be in the vehicle for steering and braking operations when the vehicle is being towed. Passengers other than the driver must not be in the vehicle.**

Always follow these emergency towing precautions:

- Place the ignition switch in the ACC position so the steering wheel is not locked.
- Place the shift button in N (Neutral).
- Release the parking brake.
- Depress the brake pedal with more force than normal since you will have reduced braking performance.
- More steering effort will be required because the power steering system will be disabled.
- Use a vehicle heavier than your own to tow your vehicle.
- The drivers of both vehicles should communicate with each other frequently.
- Before emergency towing, check that the hook is not broken or damaged.
- Fasten the towing cable or chain securely to the hook.
- Do not jerk the hook. Apply steady and even force.



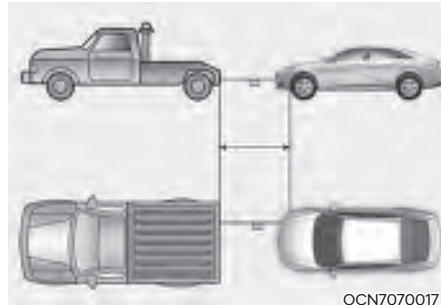

- Use a towing cable or chain less than 5 m (16 feet) long. Attach a white or red cloth (about 30 cm (12 inches) wide) in the middle of the cable or chain for easy visibility.
- Drive carefully so the towing cable or chain remains tight during towing.
- Before towing, check the Intelligent Variable Transmission (IVT) /Dual clutch transmission for fluid leaks under your vehicle. If the Intelligent Variable Transmission (IVT) /Dual clutch transmission fluid is leaking, flatbed equipment or a towing dolly must be used.

### **NOTICE**

**Accelerate or decelerate the vehicle in a slow and gradual manner while maintaining tension on the tow rope or chain to start or drive the vehicle, otherwise tow hooks and the vehicle may be damaged.**

### **NOTICE**

**To avoid damage to your vehicle and vehicle components when towing:**

- **Always pull straight ahead when using the towing hooks. Do not pull from the side or at a vertical angle.**
- **Do not use the towing hooks to pull a vehicle out of mud, sand or other conditions from which the vehicle cannot be driven out under its own power.**
- **Limit the vehicle speed to 10mph (15km/h) and drive less than 1 mile (1.5 km) when towing to avoid serious damage to Intelligent variable transmission.**
- **The Intelligent variable transmission vehicle can be towed to a normal vehicle only without oil leakage. Check for oil leaks. Towing the vehicle with oil leakage may damage the transmission.**

## 9. Maintenance

---

Engine Compartment .....	9-3
Maintenance Services .....	9-4
Owner's Responsibility .....	9-4
Owner Maintenance Precautions.....	9-4
Owner Maintenance .....	9-5
Owner Maintenance Schedule.....	9-5
Scheduled Maintenance Services .....	9-7
Normal Maintenance Schedule (Smartstream G2.0 Atkinson) .....	9-8
Maintenance Under Severe Usage Conditions .....	9-11
Explanation of Scheduled Maintenance Items.....	9-13
Dual clutch transmission fluid .....	9-14
Engine Oil .....	9-15
Checking the Engine Oil Level.....	9-15
Checking the Engine Oil and Filter .....	9-16
Engine Coolant.....	9-17
Checking the Engine Coolant Level.....	9-17
Changing Engine Coolant.....	9-19
Brake/Clutch Fluid .....	9-20
Checking the Brake/Clutch Fluid Level .....	9-20
Washer Fluid.....	9-21
Checking the Washer Fluid Level.....	9-21
Parking Brake .....	9-21
Checking the Parking Brake .....	9-21
Air Cleaner .....	9-22
Filter Replacement.....	9-22
Cabin Air Filter.....	9-24
Filter Inspection.....	9-24
Filter Replacement.....	9-24
Wiper Blades .....	9-25
Blade Inspection .....	9-25
Blade Replacement.....	9-25
Battery .....	9-27
For Best Battery Service .....	9-28
Battery Capacity Label.....	9-28
Battery Recharging .....	9-29
Reset Items .....	9-29

Tires and Wheels.....	9-30
Tire Care.....	9-30
Recommended Cold Tire Inflation Pressures.....	9-30
Check Tire Inflation Pressure.....	9-31
Tire Rotation.....	9-32
Wheel Alignment and Tire Balance.....	9-33
Tire Replacement.....	9-33
Wheel Replacement.....	9-35
Tire Traction.....	9-35
Tire Maintenance.....	9-35
Tire Sidewall Labeling.....	9-35
Tire Terminology and Definitions.....	9-38
All Season Tires.....	9-41
Summer Tires.....	9-41
Snow Tires.....	9-41
Radial-Ply Tires.....	9-41
Low Aspect Ratio Tires.....	9-42
Fuses.....	9-43
Instrument Panel Fuse Replacement.....	9-44
Engine Compartment Panel Fuse Replacement.....	9-45
Fuse/Relay Panel Description.....	9-46
Light Bulbs.....	9-53
Headlamp, Parking Lamp, Daytime Running Light, Turn Signal Lamp and Side Marker.....	9-53
Side repeater lamp replacement.....	9-56
Rear combination lamp bulb replacement.....	9-57
High mounted stop lamp replacement.....	9-60
License Plate Light Bulb Replacement.....	9-60
Interior Light Bulb Replacement.....	9-61
Appearance Care.....	9-62
Exterior Care.....	9-62
Interior Care.....	9-68
Emission Control System.....	9-71
California Perchlorate Notice.....	9-74

## ENGINE COMPARTMENT

■ Smartstream G2.0

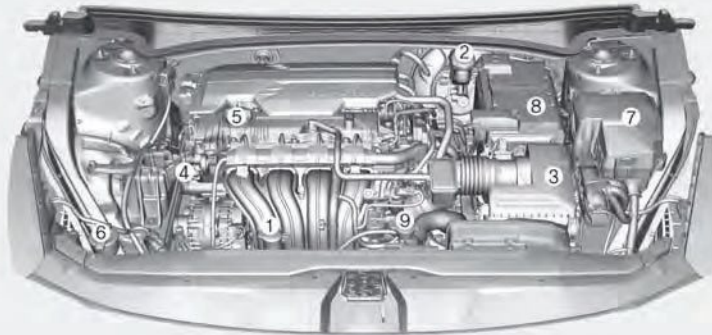

■ Smartstream G1.6 T-GDi

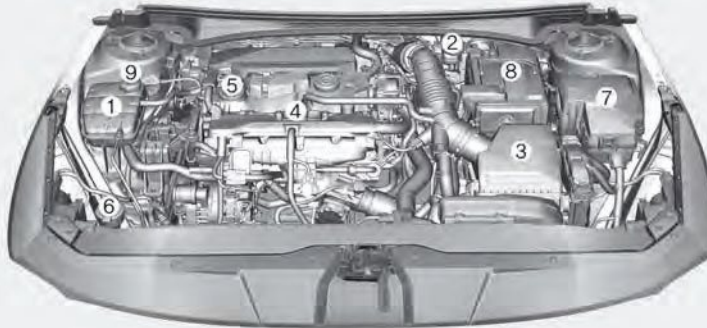

**The actual engine compartment in the vehicle may differ from the illustration.**

OCN7080064L/OCN7N080001

- |                             |                                      |
|-----------------------------|--------------------------------------|
| 1. Engine coolant reservoir | 6. Windshield washer fluid reservoir |
| 2. Brake fluid reservoir    | 7. Fuse box                          |
| 3. Air cleaner              | 8. Battery                           |
| 4. Engine oil dipstick      | 9. Radiator cap                      |
| 5. Engine oil filler cap    |                                      |

## MAINTENANCE SERVICES

You should exercise the utmost care to prevent damage to your vehicle and injury to yourself whenever performing any maintenance or inspection procedures.

We recommend you have your vehicle maintained and repaired by an authorized HYUNDAI dealer. An authorized HYUNDAI dealer meets HYUNDAI's high service quality standards and receives technical support from HYUNDAI in order to provide you with a high level of service satisfaction.

### Owner's Responsibility

Maintenance service and record retention are the owner's responsibility.

You should retain documents that show proper maintenance has been performed on your vehicle in accordance with the scheduled maintenance service charts shown on the following pages. You need this information to establish your compliance with the servicing and maintenance requirements of your vehicle warranties.

Detailed warranty information is provided in your Owner's Handbook & Warranty Information booklet.

Repairs and adjustments required as a result of improper maintenance or a lack of required maintenance are not covered.

### Owner Maintenance Precautions

Inadequate, incomplete or insufficient servicing may result in operational problems with your vehicle that could lead to vehicle damage, an accident, or personal injury. This chapter provides instructions only for the maintenance items that are easy to perform. Several procedures can be done only by an authorized HYUNDAI dealer with special tools.

Your vehicle should not be modified in any way. Such modifications may adversely affect the performance, safety or durability of your vehicle and may, in addition, violate conditions of the limited warranties covering the vehicle.

Certain modifications may also be in violation of regulations established by the U.S. Department of Transportation and other federal or state agencies.

#### **NOTICE**

**Improper owner maintenance during the warranty period may affect warranty coverage. For details, read the separate Owner's Handbook & Warranty Information booklet provided with the vehicle. If you're unsure about any service or maintenance procedure, have it done by an authorized HYUNDAI dealer.**

## OWNER MAINTENANCE



### WARNING

Performing maintenance work on a vehicle can be dangerous. If you lack sufficient knowledge and experience or the proper tools and equipment to do the work, have it done by an authorized HYUNDAI dealer.

**ALWAYS** follow these precautions for performing maintenance work:

- Park your vehicle on level ground, move the shift button into the P (Park) position, place the ignition switch in the LOCK/OFF position.
- Block the tires (front and back) to prevent the vehicle from moving. Remove loose clothing or jewelry that can become entangled in moving parts.
- If you must run the engine during maintenance, do so out doors or in an area with plenty of ventilation.
- Keep flames, sparks, or smoking materials away from the battery and fuel-related parts.

The following lists are vehicle checks and inspections that should be performed by the owner or an authorized HYUNDAI dealer at the frequencies indicated to help ensure safe, dependable operation of your vehicle.

Any adverse conditions should be brought to the attention of your dealer as soon as possible.

These Owner Maintenance vehicle checks are generally not covered by warranties and you may be charged for labor, parts and lubricants used.

### Owner Maintenance Schedule

#### *When you stop for fuel:*

- Check the engine oil level.
- Check the coolant level in the engine coolant reservoir.
- Check the windshield washer fluid level.
- Check the for low or under-inflated tires.



### WARNING

Be careful when checking your engine coolant level when the engine is hot. This may result in coolant being blown out of the opening and cause serious burns and other injuries.

### ***While operating your vehicle:***

- Note any changes in the sound of the exhaust or any smell of exhaust fumes in the vehicle.
- Check for vibrations in the steering wheel. Notice if there is any increased steering effort or looseness in the steering wheel, or change in its straight-ahead position.
- Notice if your vehicle constantly turns slightly or “pulls” to one side when traveling on smooth, level road.
- When stopping, listen and check for unusual sounds, pulling to one side, increased brake pedal travel or “hard-to-push” brake pedal.
- If any slipping or changes in the operation of your transmission occurs, check the transmission fluid level.
- Check the intelligent variable transmission P (Park) function.
- Check the parking brake.
- Check for fluid leaks under your vehicle (water dripping from the air conditioning system during or after use is normal).

### ***At least monthly:***

- Check coolant level in the engine coolant reservoir.
- Check the operation of all exterior lights, including the brake lights, turn signals and hazard warning flashers.
- Check the inflation pressures of all tires including the spare for tires that are worn, show uneven wear, or are damaged.
- Check for loose wheel lug nuts.

### ***At least twice a year: (i.e., every Spring and Autumn)***

- Check radiator, heater and air conditioning hoses for leaks or damage.
- Check windshield washer spray and wiper operation. Clean wiper blades with a clean cloth dampened with washer a fluid.
- Check headlamp alignment.
- Check muffler, exhaust pipes, shields and clamps.
- Check the seat belts for wear and function.

### ***At least once a year:***

- Clean body and door drain holes.
- Lubricate door hinges and hood hinges.
- Lubricate door and hood locks and latches.
- Lubricate door rubber weather strips.
- Lubricate door checker.
- Check the air conditioning system.
- Inspect and lubricate intelligent variable transmission linkage and controls.
- Clean the battery and terminals.
- Check the brake fluid level.

## SCHEDULED MAINTENANCE SERVICES

Follow Normal Maintenance Schedule if the vehicle is usually operated where none of the following conditions apply. If any of the following conditions apply, you must follow the Maintenance Under Severe Usage Conditions.

- Repeated short distance driving.
- Driving in dusty conditions or sandy areas.
- Extensive use of brakes.
- Driving in areas where salt or other corrosive materials are used.
- Driving on rough or muddy roads.
- Driving in mountainous areas.
- Extended periods of idling or low speed operation.
- Driving for a prolonged period in cold temperatures and/or extremely humid climates.
- More than 50% driving in heavy city traffic during hot weather above 90°F (32°C).
- Engine oil usage which is not recommended (mineral type, lower grade spec, etc.)

For additional information or assistance see your authorized HYUNDAI dealer.

### **NOTICE**

**After 10 years or 100,000 miles, we recommend to use severe maintenance schedule.**



Normal Maintenance Schedule

MAINTENANCE ITEM	MAINTENANCE INTERVALS		12	24	36	48	60	72	84	96	108	120	132	144	156	
	Months	Miles*1,000	8	16	24	32	40	48	56	64	72	80	88	96	104	
	Km*1,000		13	26	39	52	65	78	91	104	117	130	143	156	169	
Engine oil and engine oil filter *1	Smartstream G2.0 Atkinson		R	R	R	R	R	R	R	R	R	R	R	R	R	R
	Smartstream G1.6 T-GDI		R	R	R	R	R	R	R	R	R	R	R	R	R	R
Fuel additives *2			Add fuel additives every 8,000 miles (13,000 km) or 12 months													
Air cleaner filter			I	I	R	I	I	R	I	I	R	I	I	R	I	I
Air intake hose			I	I	I	I	I	I	I	I	I	I	I	I	I	I
Spark plugs	Smartstream G2.0 Atkinson		Replace every 96,000 miles													
	Smartstream G1.6 T-GDI		Replace every 47,000 miles													
Rotate tires			Rotate tires every 8,000 miles (13,000 km)													
Cabin air filter				R		R		R		R		R		R		R
Drive belts *3			At first, inspect at 48,000 miles (78,000 km) or 72 months. Thereafter, inspect every 16,000 miles (26,000 km) or 24 months													

R: Replace or change.

I: Inspect and if necessary, adjust, correct, clean or replace.

\*1: Requires API SN PLUS (or above) grade engine oil. If a lower grade engine oil is used, then the engine oil and engine oil filter must be replaced at every 5,000 miles (8,000 km) or 6 months as indicated for severe maintenance condition.

\*2: If TOP TIER Detergent Gasoline is not available, one bottle of additive is recommended. Additives are available from your authorized HYUNDAI dealer along with information on how to use them. Do not mix other additives.

\*3: The drive belt should be replaced when cracks occur or tension is reduced excessively.

\* As it is normal for engine oil to be consumed during driving, the amount of engine oil should be checked regularly.  
 \* The replacement cycle of engine oil is set by the period which the performance of our recommended engine oil is maintained. So, if recommended engine oil is not used, a replacement is required as indicated severe usage condition.

## Normal Maintenance Schedule (CONT)

MAINTENANCE ITEM	MAINTENANCE INTERVALS		12	24	36	48	60	72	84	96	108	120	132	144	156	
	Months	Miles*1,000	8	16	24	32	40	48	56	64	72	80	88	96	104	
	Km*1,000		13	26	39	52	65	78	91	104	117	130	143	156	169	
Vacuum hose			I	I	I	I	I	I	I	I	I	I	I	I	I	I
Engine coolant			At first, replace at 120,000 miles or 120 months. Thereafter, replace every 30,000 miles or 24 months													
Battery condition			I	I	I	I	I	I	I	I	I	I	I	I	I	I
Brake lines, hoses and connections			I	I	I	I	I	I	I	I	I	I	I	I	I	I
Disc brakes and pads			I	I	I	I	I	I	I	I	I	I	I	I	I	I
Steering gear rack, linkage and boots / lower arm ball joint, upper arm ball joint			I	I	I	I	I	I	I	I	I	I	I	I	I	I
Driveshaft and boots			I	I	I	I	I	I	I	I	I	I	I	I	I	I
Suspension mounting bolts			I	I	I	I	I	I	I	I	I	I	I	I	I	I
Air conditioner refrigerant			I	I	I	I	I	I	I	I	I	I	I	I	I	I
Air conditioner compressor			I	I	I	I	I	I	I	I	I	I	I	I	I	I
Exhaust pipe and muffler			I	I	I	I	I	I	I	I	I	I	I	I	I	I
Manual transmission fluid (if equipped) *1			Replace every 40,000miles or 4 years													
Intelligent variable transmission fluid (if equipped) *2			No check, No service required													
Dual clutch transmission fluid (if equipped)*1																
Rear differential oil *1			I	I	I	I	I	I	I	I	I	I	I	I	I	I

R: Replace or change.

I : Inspect and if necessary, adjust, correct, clean or replace.

\*1 : Manual transmission fluid/Dual clutch transmission fluid should be changed anytime they have been submerged in water.

\*2 : Use only the specified intelligent variable transmission fluid. (Refer to "Recommended lubricants and capacities" section in chapter 2 or the label in the engine compartment.)



### Maintenance Under Severe Usage Conditions

The following items must be serviced more frequently on cars mainly used under severe driving conditions. Refer to the chart below for the appropriate maintenance intervals.

R : Replace

I : Inspect and if necessary, adjust, correct, clean or replace

Maintenance item		Maintenance operation	Maintenance intervals	Driving condition
Engine oil and filter *1	Smartstream G2.0 Atkinson	R	Replace every 5,000 miles (8,000 km) or 6 months	A, B, C, D, E, F, G, H, I, J, K, L
	Smartstream G1.6 T-GDi			A, B, C, D, E, F, G, H, I, J, K, L
Air cleaner filter		I	Inspect more frequently depending on the condition	C, E
Spark plugs		R	Replace more frequently depending on the condition	A, B, F, G, H, I, K
Steering gear rack, linkage and boots		I	Inspect more frequently depending on the condition	C, D, E, F, G
Front suspension ball joints		I	Inspect more frequently depending on the condition	C, D, E, F, G
Disc brakes and pads, calipers and rotors		I	Inspect more frequently depending on the condition	C, D, E, G, H
Parking brake		I	Inspect more frequently depending on the condition	C, D, G, H
Driveshaft and boots		I	Inspect more frequently depending on the condition	C, D, E, F, G, H, I, J
Cabin air filter		R	Replace more frequently depending on the condition	C, E, G
Manual transmission fluid (if equipped)		R	Replace every 80,000miles (120,000 km)	C, D, E, F, G, H, I, J
Intelligent variable transmission fluid (if equipped)		R	Replace every 60,000miles (90,000 km)	A, C, D, E, F, G, H, I, K
Dual clutch transmission fluid (if equipped)		R	Replace every 80,000miles (120,000km)	C, D, E, F, G, H, I, J
Rear differential oil		R	Replace every 72,000 miles (120,000 km)	C, D, E, G, H, I, J
Transfer case oil		No check, No service required		

\*1: Requires <API SN PLUS (or above)> grade engine oil. If a lower grade engine oil (mineral oil) is used, then the engine oil and engine oil filter must be replaced as indicated for severe maintenance condition.

### ***Severe driving conditions***

- A. Repeatedly driving short distance of less than 5 miles (8 km) in normal temperature or less than 10 miles (16 km) in freezing temperature
- B. Extensive engine idling or low speed driving for long distances
- C. Driving on rough, dusty, muddy, unpaved, graveled or saltspread roads
- D. Driving in areas using salt or other corrosive materials or in very cold weather
- E. Driving in the condition of inflowing sand or dust into engine
- F. Driving in heavy traffic area
- G. Driving on uphill, downhill, or mountain roads
- H. Using for towing or camping, and driving with loading on the roof.
- I. Driving for patrol car, taxi, commercial car or vehicle towing
- J. Frequently driving under high speed or rapid acceleration.
- K. Frequently driving in stop-and-go conditions
- L. Engine oil usage which is not recommended (Mineral type, Semi-synthetic, Lower grade spec, etc.)

## EXPLANATION OF SCHEDULED MAINTENANCE ITEMS

### Engine Oil and Filter

The engine oil and filter should be changed at the intervals specified in the maintenance schedule. If the vehicle is being driven in severe conditions, more frequent oil and filter changes are required.

### Drive Belts

Inspect all drive belts for evidence of cuts, cracks, excessive wear or oil saturation and replace if necessary. Drive belts should be checked periodically for proper tension and adjusted as necessary.

### Fuel Filter

A clogged-up fuel filter may limit the vehicle driving speed, damage the emission system, and cause the hard starting. When a considerable amount of foreign substances are accumulated in the fuel tank, the fuel filter should be replaced.

Upon installing a new fuel filter, operate the engine for several minutes, and check the connections for any leakages. Fuel filters should be installed by an authorized HYUNDAI dealer.

### Fuel Lines, Fuel Hoses and Connections

Check the fuel lines, fuel hoses and connections for leakage and damage. Have an authorized HYUNDAI dealer replace any damaged or leaking parts immediately.

### Vapor Hose and Fuel Filler Cap

The vapor hose and fuel filler cap should be inspected at those intervals specified in the maintenance schedule. Make sure a new vapor hose or fuel filler cap is correctly replaced.

### Air Cleaner Filter

A genuine HYUNDAI air cleaner filter is recommended when the filter is replaced.

### Spark Plugs

Make sure to install new spark plugs of the correct heat range.

### Cooling System

Check cooling system components, such as radiator, coolant reservoir, hoses and connections for leakage and damage. Replace any damaged parts.

### Engine Coolant

The coolant should be changed at the intervals specified in the maintenance schedule.

### Manual Transmission Fluid (if equipped)

Inspect the manual transmission fluid according to the maintenance schedule.

### Intelligent variable transmission fluid (if equipped)

Intelligent variable transmission fluid should not be checked under normal usage conditions.

We recommend that the Intelligent variable transmission fluid is changed by an authorized HYUNDAI dealer according to the maintenance schedule.

### Dual clutch transmission fluid (if equipped)

Dual clutch transmission fluid should not be checked under normal usage conditions.

We recommend that the Intelligent variable transmission fluid is changed by an authorized HYUNDAI dealer according to the maintenance schedule.

### Brake Hoses and Lines

Visually check for proper installation, chafing, cracks, deterioration and any leakage. Replace any deteriorated or damaged parts immediately.

### Brake Fluid

Check the brake fluid level in the brake fluid reservoir. The level should be between the MIN and the MAX marks on the side of the reservoir. Use only hydraulic brake fluid conforming to DOT 4 specification..

### Parking Brake

Inspect the parking brake system including the parking brake pedal and cables.

### Brake Discs, Pads, Calipers and Rotors

Check the pads for excessive wear, discs for run out and wear, and calipers for fluid leakage.

### Suspension Mounting Bolts

Check the suspension connections for looseness or damage. Retighten to the specified torque.

### Steering Gear Box, Linkage & Boots/Lower Arm Ball Joint

With the vehicle stopped and the engine off, check for excessive freeplay in the steering wheel. Check the linkage for bends or damage. Check the dust boots and ball joints for deterioration, cracks, or damage.

Replace any damaged parts.

### Drive Shafts and Boots

Check the drive shafts, boots and clamps for cracks, deterioration, or damage. Replace any damaged parts and, if necessary, repack the grease.

### Air Conditioning Refrigerant

Check the air conditioning lines and connections for leakage and damage.

## ENGINE OIL

### Checking the Engine Oil Level

Engine oil is used for lubrication and cooling, so it is gradually consumed during driving the vehicle.

Regularly check and manage the oil level using the following procedure.

1. Follow all of the oil manufacturer's precautions.
2. Be sure the vehicle is on the level ground in P (Park) with the parking brake set. If possible, block the wheels.
3. Turn the engine on and allow the engine to reach normal operating temperature.
4. Turn the engine off and wait about fifteen minutes for the oil to return to the oil pan.
5. Pull the dipstick out, wipe it clean, and re-insert it fully.

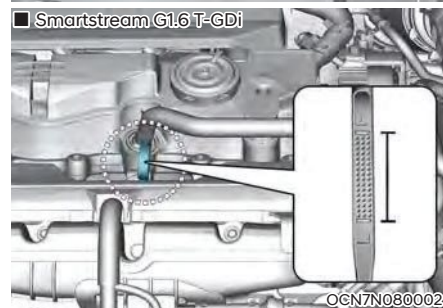
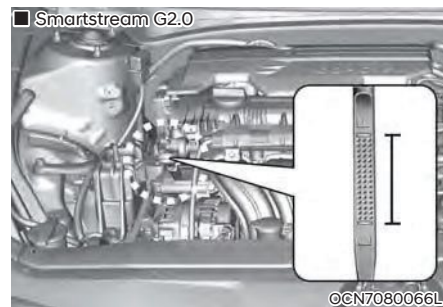

6. Pull the dipstick out again and check the level. The level should be between F and L.

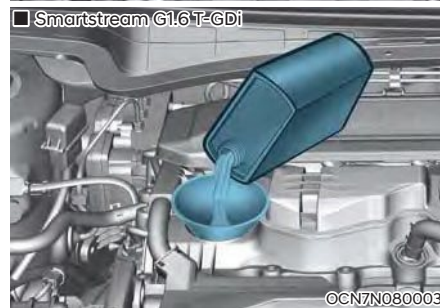

7. Check if the oil level is between the F-L line and refill it if the oil level is near the L line.

Use only the specified engine oil. (refer to “Recommended Lubricants and Capacities” in chapter 2).



**NOTICE**

To prevent damage to your engine:

- Do not overfill with engine oil. Add oil in small quantities and recheck level to ensure engine is not overfilled.
- Do not spill engine oil when adding or changing engine oil. Use a funnel to help prevent oil from being spilled on engine components. Wipe off spilled oil immediately.
- The engine oil consumption may increase while you break in a new vehicle and it will be stabilized after driving 6,000 km.
- The engine oil consumption can be affected by driving habits, climate conditions, traffic conditions, oil quality, etc. Therefore, it is recommended that you inspect the engine oil level regularly and refill it if necessary.
- The engine oil change interval is set for the purpose of preventing oil deterioration, and is not related the amount of oil consumption; so, check and refill the amount of the oil regularly.

**Checking the Engine Oil and Filter**



Have engine oil and filter changed by an authorized HYUNDAI dealer according to the Maintenance Schedule at the beginning of this chapter.



**WARNING**

**CALIFORNIA PROPOSITION 65  
WARNING**

Engine oil contains chemicals known to the State of California to cause cancer, birth defects and reproductive harm. Used engine oil may cause irritation or cancer of the skin if left in contact with the skin for prolonged periods of time. Always protect your skin by washing your hands thoroughly with soap and warm water as soon as possible after handling used oil.

## ENGINE COOLANT

The high-pressure cooling system has a reservoir filled with year-round antifreeze coolant. The reservoir is filled at the factory.

Check the antifreeze protection and coolant level at least once a year, at the beginning of the winter season and before traveling to a colder climate.

### NOTICE

- **When the engine overheats from low engine coolant, suddenly adding engine coolant may cause cracks in the engine. To prevent damage, add engine coolant slowly in small quantities.**
- **Do not drive with no engine coolant. It may cause water pump failure and engine seizure, etc.**

### Checking the Engine Coolant Level

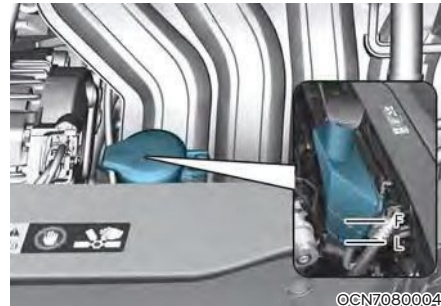

OCN7080004

■ Smartstream G1.6 T-GDi

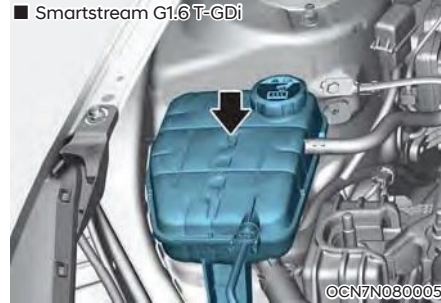

OCN7N080005

Check the condition and connections of all cooling system hoses and heater hoses. Replace any swollen or deteriorated hoses.

The coolant level should be filled between the F and the L marks on the side of the coolant reservoir when the engine is cool.

If the coolant level is low, add enough distilled (deionized) water to bring the level to the F mark, but do not overfill. If frequent additions are required, see an authorized HYUNDAI dealer for a cooling system inspection.

**WARNING**

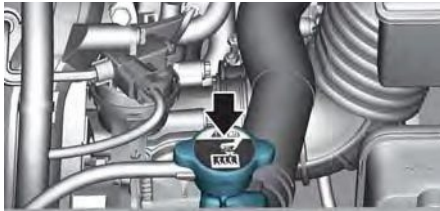

©CN7080005

■ Smartstream G1.6T-GDI



©CN7N080006

1. Check if the radiator cap label is straight in front.
2. Make sure that the tiny protrusions inside the radiator cap should be securely interlocked.

**Recommended engine coolant**

- When adding coolant, use only distilled (deionized) water for your vehicle and never mix hard water in the coolant filled at the factory.
- An improper coolant mixture can result in severe malfunction or engine damage.
- The engine in your vehicle has aluminum engine parts and must be protected by an ethylene-glycol with phosphate based coolant to prevent corrosion and freezing.
- Do not use alcohol or methanol coolant or mix them with the specified coolant.
- Do not use a solution that contains more than 60% antifreeze or less than 35% antifreeze, which would reduce the effectiveness of the solution.

For mixing percentage, refer to the following table:

Ambient Temperature	Mixture Percentage (volume)	
	Antifreeze	Water
5°F (-15°C)	35	65
-13°F (-25°C)	40	60
-31°F (-35°C)	50	50
-49°F (-45°C)	60	40

**i Information**

If in doubt about the mix ratio, a 50% water and 50% antifreeze mix is the easiest to mix together as it will be the same quantity of each. It is suitable to use for most temperature ranges of - 31°F and higher.

**WARNING**

The electric motor for the cooling fan may continue to operate or start up when the engine is not running and can cause serious injury. Keep hands, clothing and tools away from the rotating fan blades of the cooling fan.

The electric motor for the cooling fan is controlled by engine coolant temperature, refrigerant pressure and vehicle speed. As the engine coolant temperature decreases, the electric motor will automatically shut off. This is a normal condition.

**Changing Engine Coolant**

Have coolant changed by an authorized HYUNDAI dealer according to the Maintenance Schedule at the beginning of this chapter.

**WARNING**

Do not use engine coolant or antifreeze in the washer fluid reservoir.

Engine coolant can severely obscure visibility when sprayed on the windshield and may cause loss of vehicle control resulting in an accident.

Engine coolant may also cause damage to paint and body trim.

**NOTICE**

To prevent damage to engine parts, put a thick towel around the radiator cap before refilling the coolant to prevent the coolant from overflowing into engine parts, such as the alternator.

## BRAKE/CLUTCH FLUID

### Checking the Brake/Clutch Fluid Level

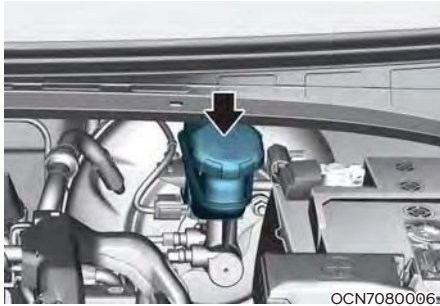

Check the fluid level in the reservoir periodically. The fluid level should be between MAX and MIN marks on the side of the reservoir.

Before removing the reservoir cap and adding brake fluid, clean the area around the reservoir cap thoroughly to prevent brake fluid contamination.

If the level is low, add fluid to the MAX level. The level will fall with accumulated mileage. This is a normal condition associated with the wear of the brake linings.

If the fluid level is excessively low, we recommend that the system be checked by an authorized HYUNDAI dealer.

#### **i** Information

Use only the specified brake/clutch fluid. Refer to “Recommended lubricants and capacities” in chapter 2.

#### **i** Information

Before removing the brake/clutch filler cap, read the warning on the cap.

#### **i** Information

Clean the filler cap before removing. Use only DOT4 brake/clutch fluid from a sealed container.

#### **!** WARNING

Do not allow brake fluid to come in contact with your eyes. If brake/clutch fluid comes in contact with your eyes, flush your eyes with clean water for at least 15 minutes and get immediate medical attention.

#### **NOTICE**

- Do not allow brake/clutch fluid to contact the vehicle's body paint, as paint damage will result.
- Brake/clutch fluid, which has been exposed to open air for an extended time should never be used as its quality cannot be guaranteed. It should be disposed of properly.
- Don't put in the wrong kind of fluid. A few drops of mineralbased oil, such as engine oil, in your brake system can damage system parts.
- To maintain the best braking performance and ABS/ESC performance, we recommend that you use genuine brake/clutch fluid that conform to specifications.

(Standard : SAE J1704 DOT-4 LV, ISO4925 CLASS-6 and FMVSS 116 DOT-4)

## WASHER FLUID

### Checking the Washer Fluid Level

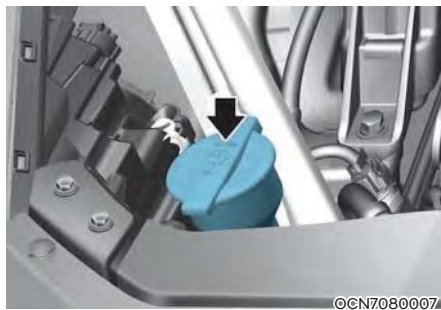

Check the fluid level in the washer fluid reservoir and add fluid if necessary. Plain water may be used if washer fluid is not available. However, use washer solvent with antifreeze characteristics in cold climates to prevent freezing.



### WARNING

To prevent serious injury or death, take the following safety precautions when using washer fluid:

- Do not use engine coolant or antifreeze in the washer fluid reservoir.  
Engine coolant can severely obscure visibility when sprayed on the windshield and may cause loss of vehicle control resulting in an accident or damage to paint and body trim.
- Do not allow sparks or flames to contact the washer fluid or the washer fluid reservoir. Washer fluid may contain alcohol and can be flammable.
- Do not drink washer fluid and avoid contact with skin. Washer fluid is harmful to humans and animals.
- Keep washer fluid away from children and animals.

## PARKING BRAKE

### Checking the Parking Brake



Check the stroke of the parking brake by counting the number of “clicks” heard while fully applying it from the released position. Also, the parking brake alone should securely hold the vehicle on a fairly steep grade. If the stroke is more or less than specified, we recommend that the system be serviced by an authorized HYUNDAI dealer.

**Stroke : 5-8 “clicks” at a force of 44 lbs (20 kg, 196 N)**

## AIR CLEANER

### Filter Replacement

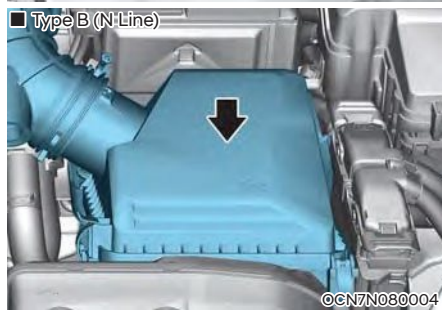
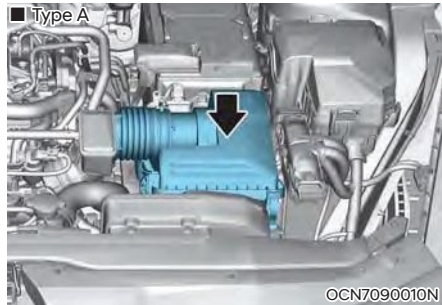

The air cleaner filter can be cleaned for inspection using compressed air. Do not attempt to wash or to rinse it, as water will damage the filter. If soiled, the air cleaner filter must be replaced.

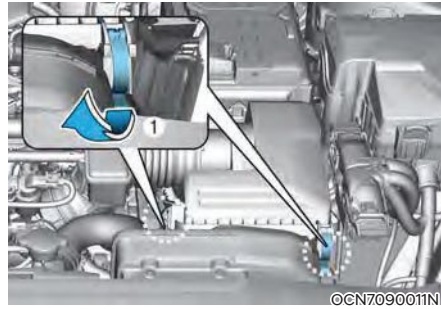

1. Loosen the air cleaner cover attaching clip (1) and open the cover.

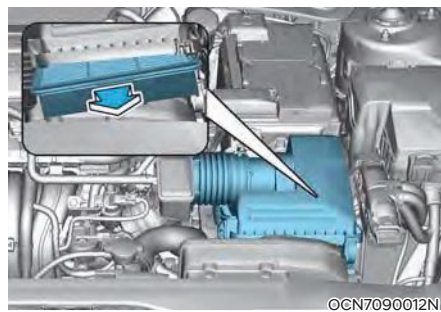

2. Replace the air cleaner filter.

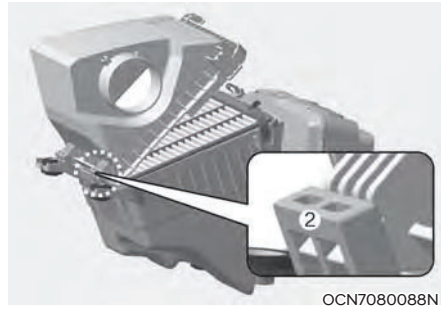

3. Insert the air cleaner cover in the hinge (2) and engage the clip (1) after closing the cover.
4. Check that the cover is firmly installed.

### **i** Information

If the vehicle is operated in extremely dusty or sandy areas, replace the element more often than the usual recommended intervals (refer to “Maintenance Under Severe Usage Conditions” in this chapter).

### **NOTICE**

- Do not drive with the air cleaner filter removed. This will result in excessive engine wear.
- When removing the air cleaner filter, be careful that dust or dirt does not enter the air intake, or damage may result.
- Use HYUNDAI genuine parts. Use of non-genuine parts could damage the engine.



## CABIN AIR FILTER

### Filter Inspection

The cabin air filter should be replaced according to the Maintenance Schedule. If the vehicle is operated in severely air-polluted cities or on dusty rough roads for a long period, it should be inspected more frequently and replaced earlier. When you replace the cabin air filter, replace it performing the following procedure, and be careful to avoid damaging other components.

### Filter Replacement



1. Push in both sides of the glove box as shown. This will ensure that the glove box stopper pins will get released from its holding location allowing the glove box to hang.



2. Remove the cabin air filter case while pressing the lock on the right side of the cover.

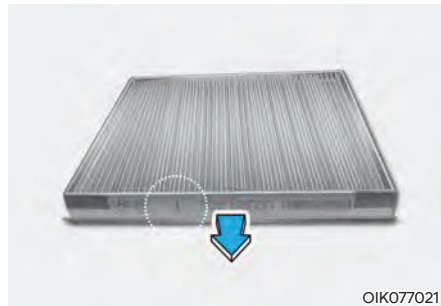

3. Replace the cabin air filter.
4. Reassemble in the reverse order of disassembly.

### NOTICE

Install a new cabin air filter in the correct direction with the arrow symbol (↓) facing downwards, otherwise, it may be noisy and the effectiveness of the filter may be reduced.

## WIPER BLADES

### Blade Inspection

Contamination of either the windshield or the wiper blades with foreign matter can reduce the effectiveness of the windshield wiper functionality. Common sources of contamination are insects, tree sap, and hot wax treatments used by some commercial car washes. If the blades are not wiping properly, clean both the window and the blades with a clean cloth dampened with washer fluid.

#### **NOTICE**

To prevent damage to the wiper blades, arms or other components, do not:

- Use gasoline, kerosene, paint thinner, or other solvents on or near them.
- Attempt to move the wipers manually.
- Use non-specified wiper blades.

#### **i** Information

Commercial hot waxes applied by automatic car washes have been known to make the windshield difficult to clean.

### Blade Replacement

When the wipers no longer clean adequately, the blades may be worn or cracked, and require replacement.

#### **NOTICE**

- In order to prevent damage to the hood and the wiper arms, the wiper arms should only be lifted when in the top wiping position.
- Always return the wiper arms to the windshield before driving.

#### **NOTICE**

The use of a non-specified wiper blade could result in wiper malfunction and failure.

### Front windshield wiper service positions

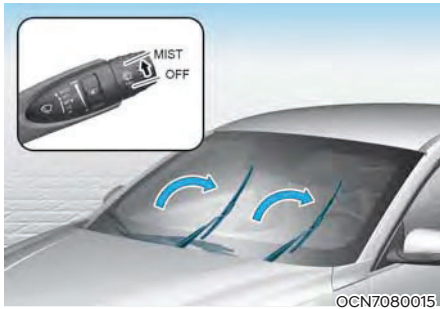

This vehicle has a “hidden” wiper design which means that the wipers cannot be lifted when they are in their bottom resting position.

1. Within 20 seconds of turning off the engine, lift and hold the wiper lever up to the MIST position for about 2 seconds until the wipers move to the top wipe position.
2. At this time you can lift the wipers off the windshield.
3. Gently put the wipers back down onto the windshield.
4. Turn the wipers to any ON position to return the wipers to the bottom resting position.

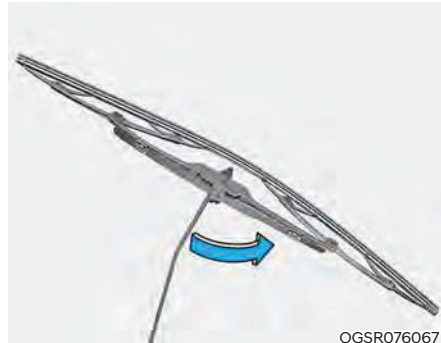

1. Raise the wiper arm.

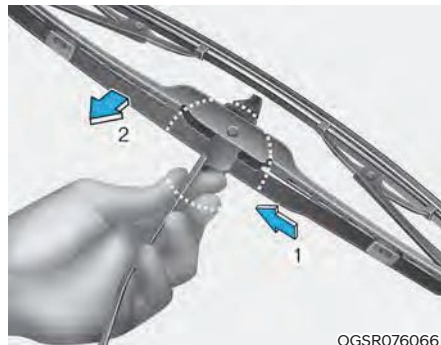

2. Lift up the wiper blade clip. Then pull down the blade assembly and remove it.



3. Install the new blade assembly.
4. Return the wiper arm on the windshield.

## BATTERY



### WARNING

To prevent **SERIOUS INJURY** or **DEATH** to you or bystanders, always follow these precautions when working near or handling the battery:



Always read and follow instructions carefully when handling a battery.



Wear eye protection designed to protect the eyes from acid splashes.



Keep all flames, sparks, or smoking materials away from the battery.



Hydrogen is always present in battery cells, is highly combustible, and may explode if ignited.



Keep batteries out of reach of children.



Batteries contain sulfuric acid which is highly corrosive. Do not allow acid to contact your eyes, skin or clothing.

If acid gets into your eyes, flush your eyes with clean water for at least 15 minutes and get immediate medical attention. If acid gets on your skin, thoroughly wash the area. If you feel pain or a burning sensation, get medical attention immediately.

- When lifting a plastic-cased battery, excessive pressure on the case may cause battery acid to leak. Lift with a battery carrier or with your hands on opposite corners.
- Do not attempt to jump start your vehicle if your battery is frozen.
- **NEVER** attempt to recharge the battery when the vehicle's battery cables are connected to the battery.
- The electrical ignition system works with high voltage. **NEVER** touch these components with the engine running or when the ignition switch is in the ON position.
- Do not allow the (+) and (-) jumper cables to touch. It may cause sparks.
- The battery may rupture or explode when you jump start with a low or frozen battery.
- Leaked battery electrolyte due to repeated driving on sharp curves (e.g. on circuits) may cause safety problem. Avoid repeated driving on sharp curves.



### WARNING

#### CALIFORNIA PROPOSITION 65 WARNING

Battery posts, terminals, and related accessories contain lead and lead compounds, chemicals known to the State of California to cause cancer, birth defects and reproductive harm. Batteries also contain other chemicals known to the State of California to cause cancer. Wash hands after handling.

**NOTICE**

- When you do not use the vehicle for a long time in a low temperature area, disconnect the battery and keep it indoors.
- Always charge the battery fully to prevent battery case damage in low temperature areas.

**NOTICE**

If you connect unauthorized electronic devices to the battery, the battery may be discharged. Never use unauthorized devices.

**For Best Battery Service**

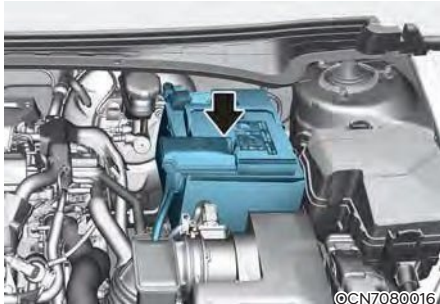

- Keep the battery securely mounted.
- Keep the battery top clean and dry.
- Keep the terminals and connections clean, tight, and coated with petroleum jelly or terminal grease.
- Rinse any spilled acid from the battery immediately with a solution of water and baking soda.

**Battery Capacity Label**

- Example
- Type A



OCN7080076L

- Type B



OCN7080077L

\* The actual battery label in the vehicle may differ from the illustration.

1. AGM70L-DIN: The HYUNDAI model name of battery
2. 12V : The nominal voltage
3. 70Ah (20HR): The nominal capacity (in Ampere hours)
4. RC 120min: The nominal reserve capacity (in min.)
5. CCA: The cold-test current in amperes by SAE
6. 760A: The cold-test current in amperes by EN

## Battery Recharging



### WARNING

Always follow these instructions when recharging your vehicle's battery to avoid the risk of **SERIOUS INJURY** or **DEATH** from explosions or acid burns:

- Before performing maintenance or recharging the battery, turn off all accessories and place the ignition switch to the LOCK/OFF position.
- Keep all flames, sparks, or smoking materials away from the battery.
- Always work outdoors or in an area with plenty of ventilation.
- Wear eye protection when checking the battery during charging.
- The battery must be removed from the vehicle and placed in a well ventilated area.
- Watch the battery during charging, and stop or reduce the charging rate if the battery cells begin boiling violently.
- Vehicle is equipped with the Absorbent Glass Mat (AGM) battery. Do not charge the AGM battery with a general charger. It may damage or explode the AGM battery. Only charge the AGM battery with a charger that has AGM battery setting.
- The negative battery cable must be removed first and installed last when the battery is disconnected. Disconnect the battery charger in the following order:
  1. Turn off the battery charger main switch.
  2. Unhook the negative clamp from the negative battery terminal.
  3. Unhook the positive clamp from the positive battery terminal.
- Always use a genuine HYUNDAI approved battery when you replace the battery.

### NOTICE

#### AGM battery (if equipped)

- Absorbent Glass Matt (AGM) batteries are maintenance-free and we recommend that the AGM battery be serviced by an authorized HYUNDAI dealer. For charging your AGM battery, use only fully automatic battery chargers that are specially developed for AGM batteries.
- When replacing the AGM battery, we recommend that you use parts for replacement from an authorized HYUNDAI dealer.
- Do not open or remove the cap on top of the battery. This may cause leaks of internal electrolyte that could result in severe injury.

#### By jump starting

After a jump start from a good battery, drive the vehicle for 20-30 minutes before it is shutoff. The vehicle may not restart if you shut it off before the battery had a chance to adequately recharge. See "Jump Starting" in chapter 7 for more information on jump starting procedures.



### Information



An inappropriately disposed battery can be harmful to the environment and human health. Dispose of the battery according to your local law(s) or regulations.

#### Reset Items

Items should be reset after the battery has been discharged or the battery has been disconnected.

- Auto up/down window (See chapter 5)
- Sunroof (See chapter 5)
- Trip computer (See chapter 4)
- Climate control system (See chapter 5)

## TIRES AND WHEELS

### WARNING

Tire failure may cause loss of vehicle control resulting in an accident. To reduce risk of **SERIOUS INJURY** or **DEATH**, take the following precautions:

- Inspect your tires monthly for proper inflation as well as wear and damage.
- The recommended cold tire pressure for your vehicle can be found in this manual and on the tire label located on the driver's side center pillar. Always use a tire pressure gauge to measure tire pressure. Tires with too much or too little pressure wear unevenly causing poor handling.
- Check the pressure of the spare every time you check the pressure of the other tires on your vehicle.
- Replace tires that are worn, show uneven wear, or are damaged. Worn tires can cause loss of braking effectiveness, steering control, or traction.
- **ALWAYS** replace tires with the same type, size, brand, construction and tread pattern as each tire that was originally supplied with this vehicle. Using tires and wheels other than the recommended sizes could cause unusual handling characteristics, poor vehicle control, or negatively affect your vehicle's Anti-Lock Brake System (ABS) resulting in a serious accident.

### Tire Care

For proper maintenance, safety, and maximum fuel economy, you must always maintain recommended tire inflation pressures and stay within the load limits and weight distribution recommended for your vehicle.



All specifications (sizes and pressures) can be found on a label attached to the driver's side center pillar.

### Recommended Cold Tire Inflation Pressures

All tire pressures (including the spare) should be checked when the tires are cold. "Cold tires" means the vehicle has not been driven for at least three hours or has been driven for less than one mile (1.6 km).

Warm tires normally exceed recommended cold tire pressures by 4 to 6 psi (28 to 41 kPa). Do not release air from warm tires to adjust the pressure or the tires will be under-inflated. For recommended inflation pressure, refer to "Tire and Wheels" in chapter 2.

**WARNING**

Recommended pressures must be maintained for the best ride, vehicle handling, and minimum tire wear.

Over-inflation or under-inflation can reduce tire life, adversely affect vehicle handling, and lead to sudden tire failure that could result in loss of vehicle control resulting in an accident.

Severe under-inflation can lead to severe heat build-up, causing blowouts, tread separation and other tire failures that can result in the loss of vehicle control resulting in an accident. This risk is much higher on hot days and when driving for long periods at high speeds.

**CAUTION**

- Under-inflation results in excessive wear, poor handling and reduced fuel economy. Wheel deformation is also possible. Keep your tire pressures at the proper levels. If a tire frequently needs refilling, have it checked by an authorized HYUNDAI dealer.
- Over-inflation produces a harsh ride, excessive wear at the center of the tire tread, and a greater possibility of damage from road hazards.

**Check Tire Inflation Pressure**

Check your tires, including the spare tire, once a month or more.

**How to check**

Use a good quality tire pressure gauge to check tire pressure. You can not tell if your tires are properly inflated simply by looking at them. Radial tires may look properly inflated when they are under-inflated.

Remove the valve cap from the tire valve stem. Press the tire gauge firmly onto the valve to get a pressure measurement. If the cold tire inflation pressure matches the recommended pressure on the tire label located on the driver's side center pillar or in this manual. No further adjustment is necessary. If the pressure is low, add air until you reach the recommended pressure. Make sure to put the valve caps back on the valve stems. Without the valve cap, dirt or moisture could get into the valve core and cause air leakage. If a valve cap is missing, install a new one as soon as possible.

If you overfill the tire, release air by pushing on the metal stem in the center of the tire valve. Recheck the tire pressure with the tire gauge. Be sure to put the valve caps back on the valve stems. Without the valve cap, dirt or moisture could get into the valve core and cause air leakage. If a valve cap is missing, install a new one as soon as possible.

A cold tire means the vehicle has been sitting for 3 hours and driven for less than 1 mile (1.6 km) in that 3 hour period.

Allow the tire to cool before measuring the inflation pressure. Always be sure the tire is cold before inflating to the recommended pressure.



### Tire Rotation

To equalize tread wear, HYUNDAI recommends that the tires be rotated according to the maintenance schedule or sooner if irregular wear develops.

During rotation, check the tires for correct balance.

When rotating tires, check for uneven wear and damage. Abnormal wear is usually caused by incorrect tire pressure, improper wheel alignment, out-of-balance wheels, severe braking or severe cornering. Look for bumps or bulges in the tread or side of the tire. Replace the tire if you find any of these conditions. Replace the tire if fabric or cord is visible. After rotation, be sure to bring the front and rear tire pressures to specification and check lug nut tightness (proper torque is 79~94 lbf-ft [11~13 kgf-m]).

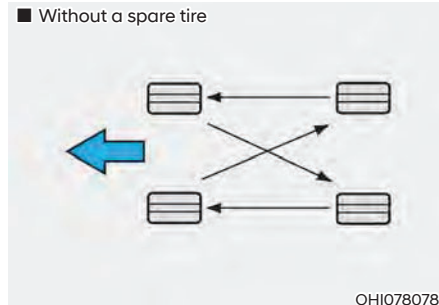

Disc brake pads should be inspected for wear whenever tires are rotated.

### **i** Information

**Tires that are asymmetrical or directional can only be installed on the wheel in one direction. The outside and inside of an asymmetrical tire is not easily distinguishable. Pay careful attention to the markings on the sidewalls of the tires, noting the “outside” marking and also the rotating direction before installing them on the vehicle.**

### **!** WARNING

- Do not use the compact spare tire for tire rotation.
- Do not mix bias ply and radial ply tires under any circumstances. This may cause unusual handling characteristics that may cause loss of vehicle control resulting in an accident.

### Wheel Alignment and Tire Balance

The wheels on your vehicle were aligned and balanced carefully at the factory to give you the longest tire life and best overall performance.

In most cases, you will not need to have your wheels aligned again. However, if you notice unusual tire wear or your vehicle pulling one way or the other, the alignment may need to be reset.

If you notice your vehicle vibrating when driving on a smooth road, your wheels may need to be rebalanced.

#### **NOTICE**

**Improper wheel weights can damage your vehicle's aluminum wheels. Use only approved wheel weights.**

### Tire Replacement



If the tire is worn evenly, a tread wear indicator will appear as a solid band across the tread. This shows there is less than 1/16 inch (1.6 mm) of tread left on the tire. Replace the tire when this happens.

Do not wait for the tread surface to become level with the tread wear indicators before replacing the tire.



### **WARNING**

To reduce the risk of **DEATH** or **SERIOUS INJURY**:

- **Replace tires that are worn, show uneven wear, or are damaged. Worn tires can cause loss of braking effectiveness, steering control, and traction.**
- **Always replace tires with the same size as each tire that was originally supplied with this vehicle. Using tires and wheels other than the recommended sizes could cause unusual handling characteristics, poor vehicle control, or negatively affect your vehicle's Anti-Lock Brake System (ABS) resulting in a serious accident.**
- **Tires degrade over time, even when they are not being used. Regardless of the remaining tread, HYUNDAI recommends that tires be replaced after six (6) years of normal service.**
- **When replacing tires, it is recommended to replace the two front or two rear tires as a pair. Replacing just one tire can seriously affect your vehicle's handling. If only replacing one pair of tires, it is recommended to install the pair of new tires on the rear axle.**
- **Heat caused by hot climates or frequent high loading conditions can accelerate the aging process. Failure to follow this warning may cause sudden tire failure, which could lead to a loss of vehicle control resulting in an accident.**

### ***Compact spare tire replacement***

A compact spare tire has a shorter tread life than a regular size tire. Replace it when you can see the tread wear indicator bars on the tire. The replacement compact spare tire should be the same size and design tire as the one provided with your new vehicle and should be mounted on the same compact spare tire wheel. The compact spare tire is not designed to be mounted on a regular size wheel, and the compact spare tire wheel is not designed for mounting a regular size tire.



### **WARNING**

**The original tire should be repaired or replaced as soon as possible to avoid failure of the spare and loss of vehicle control resulting in an accident. The compact spare tire is for emergency use only. Do not operate your vehicle over 50 mph (80 km/h) when using the compact spare tire.**

## Wheel Replacement

When replacing the metal wheels for any reason, make sure the new wheels are equivalent to the original factory units in diameter, rim width and offset.

## Tire Traction

Tire traction can be reduced if you drive on worn tires, tires that are improperly inflated or on slippery road surfaces. Tires should be replaced when the tread depth is at least  $\frac{2}{32}$  inch (1.6 mm). To reduce the possibility of losing control, slow down whenever there is rain, snow or ice on the road.

## Tire Maintenance

In addition to proper inflation, correct wheel alignment helps to decrease tire wear. If you find a tire is worn unevenly, have your dealer check the wheel alignment.

When you have new tires installed, make sure they are balanced. This will increase vehicle ride comfort and tire life. Additionally, a tire should always be rebalanced if it is removed from the wheel.

## Tire Sidewall Labeling

This information identifies and describes the fundamental characteristics of the tire and also provides the tire identification number (TIN) for safety standard certification. The TIN can be used to identify the tire in case of a recall.



### 1. Manufacturer or brand name

Manufacturer or brand name is shown.

### 2. Tire size designation

A tire's sidewall is marked with a tire size designation. You will need this information when selecting replacement tires for your car. The following explains what the letters and numbers in the tire size designation mean.

Example tire size designation:

(These numbers are provided as an example only; your tire size designator could vary depending on your vehicle.)

#### **205/55R16 91H**

205 - Tire width in millimeters.

55 - Aspect ratio. The tire's section height as a percentage of its width.

R - Tire construction code (Radial).

16 - Rim diameter in inches.

91 - Load Index, a numerical code associated with the maximum load the tire can carry.

H - Speed Rating Symbol. See the speed rating chart in this section for additional information.

### Wheel size designation

Wheels are also marked with important information that you need if you ever have to replace one. The following explains what the letters and numbers in the wheel size designation mean.

Example wheel size designation:

**6.5J X 16**

6.5 - Rim width in inches.

J - Rim contour designation.

16 - Rim diameter in inches.

### Tire speed ratings

The chart below lists many of the different speed ratings currently being used for passenger vehicle tires. The speed rating is part of the tire size designation on the sidewall of the tire. This symbol corresponds to that tire's designed maximum safe operating speed.

Speed Rating Symbol	Maximum Speed
S	112 mph (180 km/h)
T	118 mph (190 km/h)
H	130 mph (210 km/h)
V	149 mph (240 km/h)
W	168 mph (270 km/h)
Y	186 mph (300 km/h)

### 3. Checking tire life (TIN : Tire Identification Number)

Any tires that are over six years old, based on the manufacturing date, (including the spare tire) should be replaced by new tires. You can find the manufacturing date on the tire sidewall (possibly on the inside of the wheel), displaying the DOT Code. The DOT Code is a series of numbers on a tire consisting of numbers and English letters. The manufacturing date is designated by the last four digits (characters) of the DOT code.

#### DOT : XXXX XXXX OOOO

The front part of the DOT shows a plant code number, tire size and tread pattern and the last four numbers indicate week and year manufactured.

For example:

DOT XXXX XXXX 1420 represents that the tire was produced in the 14th week of 2020.

### 4. Tire ply composition and material

The number of layers or plies of rubber-coated fabric in the tire. Tire manufacturers also must indicate the materials in the tire, which include steel, nylon, polyester, and others. The letter "R" means radial ply construction; the letter "D" means diagonal or bias ply construction; and the letter "B" means belted-bias ply construction.

### **5. Maximum permissible inflation pressure**

This number is the greatest amount of air pressure that should be put in the tire. Do not exceed the maximum permissible inflation pressure. Refer to the Tire and Loading Information label for recommended inflation pressure.

### **6. Maximum load rating**

This number indicates the maximum load in kilograms and pounds that can be carried by the tire. When replacing the tires on the vehicle, always use a tire that has the same load rating as the factory installed tire.

### **7. Uniform tire quality grading**

Quality grades can be found where applicable on the tire sidewall between tread shoulder and maximum section width.

For example:

TREAD WEAR 200

TRACTION AA

TEMPERATURE A

### **Tread wear**

The tread wear grade is a comparative rating based on the wear rate of the tire when tested under controlled conditions on a specified government test course. For example, a tire graded 150 would wear one-and-a-half times ( $1\frac{1}{2}$ ) as well on the government course as a tire graded 100.

The relative performance of tires depends upon the actual conditions of their use, however, and may depart significantly from the norm due to variations in driving habits, service practices and differences in road characteristics and climate.

These grades are molded on the sidewalls of passenger vehicle tires. The tires available as standard or optional equipment on your vehicle may vary with respect to grade.

### **Traction AA, A, B & C**

The traction grades, from highest to lowest, are AA, A, B and C. Those grades represent the tire's ability to stop on wet pavement as measured under controlled conditions on specified government test surfaces of asphalt and concrete. A tire marked C may have poor traction performance.



### **WARNING**

**The traction grade assigned to this tire is based on straight-ahead braking traction tests, and does not include acceleration, cornering, hydroplaning, or peak traction characteristics.**

### Temperature A, B & C

The temperature grades are A (the highest), B and C representing the tire's resistance to the generation of heat and its ability to dissipate heat when tested under controlled conditions on a specified indoor laboratory test wheel.

Sustained high temperature can cause the material of the tire to degenerate and reduce tire life, and excessive temperature can lead to sudden tire failure. Grade C responds to a level of performance which all passenger car tires must meet under the Federal Motor Vehicle Safety Standard No. 109. Grades B and A represent higher levels of performance on the laboratory test wheel than the minimum required by law.



### **WARNING**

**The temperature grade for this tire is established for a tire that is properly inflated and not overloaded. Excessive speed, under-inflation, over-inflation, or excessive loading, either separately or in combination, can cause heat build-up and possible sudden tire failure. This may cause loss of vehicle control resulting in an accident.**

## Tire Terminology and Definitions

### **Air Pressure**

The amount of air inside the tire pressing outward on the tire. Air pressure is expressed in pounds per square inch (psi) or kilopascal (kPa).

### **Accessory Weight**

This means the combined weight of optional accessories. Some examples of optional accessories are automatic transmission, power seats, and air conditioning.

### **Aspect Ratio**

The relationship of a tire's height to its width.

### **Belt**

A rubber coated layer of cords that is located between the plies and the tread. Cords may be made from steel or other reinforcing materials.

### **Bead**

The tire bead contains steel wires wrapped by steel cords that hold the tire onto the rim.

### **Bias Ply Tire**

A pneumatic tire in which the plies are laid at alternate angles less than 90 degrees to the centerline of the tread.

### **Cold Tire Pressure**

The amount of air pressure in a tire, measured in pounds per square inch (psi) or kilopascals (kPa) before a tire has built up heat from driving.

**Curb Weight**

This means the weight of a motor vehicle with standard and optional equipment including the maximum capacity of fuel, oil and coolant, but without passengers and cargo.

**DOT Markings**

A code molded into the sidewall of a tire signifying that the tire is in compliance with the U.S. Department of Transportation motor vehicle safety standards. The DOT code includes the Tire Identification Number (TIN), an alphanumeric designator which can also identify the tire manufacturer, production plant, brand and date of production.

**GVWR**

Gross Vehicle Weight Rating

**GAWR FRT**

Gross Axle Weight Rating for the Front Axle.

**GAWR RR**

Gross Axle Weight Rating for the Rear axle.

**Intended Outboard Sidewall**

The side of an asymmetrical tire, that must always face outward when mounted on a vehicle.

**Kilopascal (kPa)**

The metric unit for air pressure.

**Light truck (LT) tire**

A tire designated by its manufacturer as primarily intended for use on lightweight trucks or multipurpose passenger vehicles.

**Load ratings**

The maximum load that a tire is rated to carry for a given inflation pressure.

**Load Index**

An assigned number ranging from 1 to 279 that corresponds to the load carrying capacity of a tire.

**Maximum Inflation Pressure**

The maximum air pressure to which a cold tire may be inflated. The maximum air pressure is molded onto the sidewall.

**Maximum Load Rating**

The load rating for a tire at the maximum permissible inflation pressure for that tire.

**Maximum Loaded Vehicle Weight**

The sum of curb weight; accessory weight; vehicle capacity weight; and production options weight.

**Normal Occupant Weight**

The number of occupants a vehicle is designed to seat multiplied by 150 pounds (68 kg).

**Occupant Distribution**

Designated seating positions.

**Outward Facing Sidewall**

An asymmetrical tire has a particular side that faces outward when mounted on a vehicle. The outward facing sidewall bears white lettering or bears manufacturer, brand, and/or model name molding that is higher or deeper than the same moldings on the inner facing sidewall.

**Passenger (P-Metric) tire**

A tire used on passenger cars and some light duty trucks and multipurpose vehicles.



### **Ply**

A layer of rubber-coated parallel cords.

### **Pneumatic tire**

A mechanical device made of rubber, chemicals, fabric and steel or other materials, that, when mounted on an automotive wheel provides the traction and contains the gas or fluid that sustains the load.

### **Pneumatic options weight**

The combined weight of installed regular production options weighing over 5 lb. (2.3 kg) in excess of the standard items which they replace, not previously considered in curb weight or accessory weight, including heavy duty breaks, ride levelers, roof rack, heavy duty battery, and special trim.

### **Recommended Inflation Pressure**

Vehicle manufacturer's recommended tire inflation pressure as shown on the tire placard.

### **Radial Ply Tire**

A pneumatic tire in which the ply cords that extend to the beads are laid at 90 degrees to the centerline of the tread.

### **Rim**

A metal support for a tire and upon which the tire beads are seated.

### **Sidewall**

The portion of a tire between the tread and the bead.

### **Speed Rating**

An alphanumeric code assigned to a tire indicating the maximum speed at which a tire can operate.

### **Traction**

The friction between the tire and the road surface. The amount of grip provided.

### **Tread**

The portion of a tire that comes into contact with the road.

### **Treadwear Indicators**

Narrow bands, sometimes called "wear bars", that show across the tread of a tire when only 1/16 inch of tread remains.

### **UTQGS**

Uniform Tire Quality Grading Standards is a tire information system that provides consumers with ratings for a tire's traction, temperature and treadwear. Ratings are determined by tire manufacturers using government testing procedures. The ratings are molded into the sidewall of the tire.

### **Vehicle Capacity Weight**

The number of designated seating positions multiplied by 150 lbs. (68 kg) plus the rated cargo and luggage load.

### **Vehicle Maximum Load on the Tire**

Load on an individual tire due to curb and accessory weight plus maximum occupant and cargo weight.

### **Vehicle Normal Load on the Tire**

Load on an individual tire that is determined by distributing to each axle its share of the curb weight, accessory weight, and normal occupant weight and dividing by 2.

### **Vehicle Placard**

A label permanently attached to a vehicle showing the original equipment tire size and recommended inflation pressure.

### All Season Tires

HYUNDAI specifies all season tires on some models to provide good performance for use all year round, including snowy and icy road conditions. All season tires are identified by ALL SEASON and/or M+S (Mud and Snow) on the tire sidewall. Snow tires have better snow traction than all season tires and may be more appropriate in some areas.

### Summer Tires

HYUNDAI specifies summer tires on some models to provide superior performance on dry roads. Summer tire performance is substantially reduced in snow and ice. Summer tires do not have the tire traction rating M+S (Mud and Snow) on the tire side wall. If you plan to operate your vehicle in snowy or icy conditions, HYUNDAI recommends the use of snow tires or all season tires on all four wheels.

### Snow Tires

If you equip your car with snow tires, they should be the same size and have the same load capacity as the original tires. Snow tires should be installed on all four wheels; otherwise, poor handling may result. Snow tires should carry 4 psi (28 kPa) more air pressure than the pressure recommended for the standard tires on the tire label on the driver's side of the center pillar, or up to the maximum pressure shown on the tire sidewall, whichever is less. Do not drive faster than 75 mph (120 km/h) when your vehicle is equipped with snow tires.

### Radial-Ply Tires

Radial-ply tires provide improved tread life, road hazard resistance and smoother high speed ride. The radial-ply tires used on this vehicle are of belted construction, and are selected to complement the ride and handling characteristics of your vehicle.

Radial-ply tires have the same load carrying capacity, as bias-ply or bias belted tires of the same size, and use the same recommended inflation pressure. Mixing of radial-ply tires with bias-ply or bias belted tires is not recommended. Any combinations of radial-ply and bias-ply or bias belted tires when used on the same vehicle will seriously deteriorate vehicle handling. The best rule to follow is: Identical pairs of radial-ply tires should always be used as a set for the front tires and a set for the rear tires.

Longer wearing tires can be more susceptible to irregular tread wear. It is very important to follow the tire rotation interval in this chapter to achieve the tread life potential of these tires. Cuts and punctures in radial-ply tires are repairable only in the tread area, because of sidewall flexing. Consult your tire dealer for radial-ply tire repairs.



### WARNING

**Do not mix bias ply and radial ply tires under any circumstances. This may cause unusual handling characteristics that may cause loss of vehicle control resulting in an accident.**

### Low Aspect Ratio Tires

The aspect ratio is lower than 50 on low aspect ratio tires.

Because low aspect ratio tires are optimized for handling and braking, their sidewall is a little stiffer than a standard tire. Also low aspect ratio tires tend to be wider and consequently have a greater contact patch with the road surface. In some instances they may generate more road noise compared with standard tires.



#### CAUTION

**Because the sidewall of a low aspect ratio tire is shorter than a standard tire, the rim of the wheel and the tire itself is more easily susceptible to damage. Use caution when driving and follow the guidelines below to help minimize damage to the wheel and tire:**

- **When driving on a rough road or off road, drive cautiously because tires and wheels may be damaged. And after driving, inspect tires and wheels.**
- **When passing over a pothole, speed bump, manhole, or curb stone, drive slowly so that the tires and wheels are not damaged.**
- **If the tire is subjected to a severe impact, have the tire and wheel inspected by an authorized HYUNDAI dealer.**
- **Inspect the tire condition and pressure every 1,800 miles (3,000km).**



#### CAUTION

- **It is not easy to recognize tire damage with your own eyes. But if there is the slightest hint of tire damage, have the tire checked or replaced because the tire damage may cause air leakage from the tire.**
- **If the tire is damaged by driving on a rough road, off road, pothole, manhole, or curb stone, it will not be covered by the warranty.**

## FUSES

### ■ Blade type



Normal



Blown

### ■ Cartridge type



Normal



Blown

### ■ Multi fuse



Normal

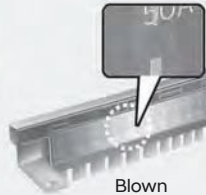

Blown

OTM078035

A vehicle's electrical system is protected from electrical overload damage by fuses.

This vehicle has 2 (or 3) fuse panels, one located in the driver's side panel bolster, the other in the engine compartment near the battery.

If any of your vehicle's lights, accessories, or controls do not work, check the appropriate circuit fuse. If a fuse has blown, the element inside the fuse will be melted or broken.

If the electrical system does not work, first check the driver's side fuse panel. Before replacing a blown fuse, turn the engine and all switches off, and then disconnect the negative battery cable. Always replace a blown fuse with one of the same rating.

If the replacement fuse blows, this indicates an electrical problem. Avoid using the system involved and immediately consult an authorized HYUNDAI dealer.

### **WARNING**

**NEVER** replace a fuse with anything but another fuse of the same rating.

- A higher capacity fuse could cause damage and possibly cause a fire.
- Do not install a wire or aluminum foil instead of the proper fuse - even as a temporary repair. It may cause extensive wiring damage and possibly a fire.

### **NOTICE**

Do not use a screwdriver or any other metal object to remove fuses because it may cause a short circuit and damage the system.

### Instrument Panel Fuse Replacement



1. Turn the vehicle off.
2. Turn all other switches OFF.
3. Open the fuse panel cover.
4. Refer to the label on the inside of the fuse panel cover to locate the suspected fuse location.

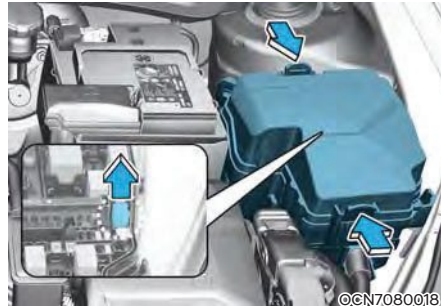

5. Pull the suspected fuse straight out. Use the removal tool provided in the engine compartment fuse panel.
6. Check the removed fuse; replace it if it is blown. Spare fuses are provided in the engine compartment fuse panel.
7. Push in a new fuse of the same rating, and make sure it fits tightly in the clips. If it fits loosely, consult an authorized HYUNDAI dealer.

In an emergency, if you do not have a spare fuse, use a fuse of the same rating from a circuit you may not need for operating the vehicle.

If the other electrical components do not work and the fuses are undamaged, check the fuse panel in the engine compartment. If a fuse is blown, it must be replaced with the same rating.

If the headlamp, turn signal lamp, tail lamp, interior lamp doesn't work and the fuses are undamaged, consult an authorized HYUNDAI dealer.

## Engine Compartment Panel Fuse Replacement

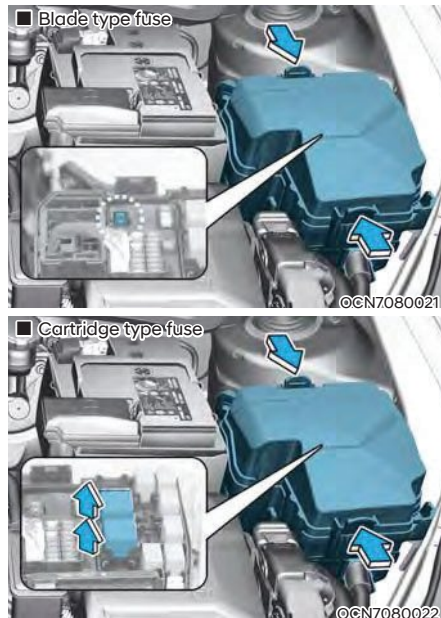

1. Turn the engine off.
2. Turn all other switches OFF.
3. Remove the fuse panel cover by pressing the tap and pulling up.
4. Check the removed fuse; replace it if it is blown. To remove or insert the fuse, use the fuse puller in the engine compartment fuse panel.
5. Push in a new fuse of the same rating, and make sure it fits tightly in the clips. If it fits loosely, consult an authorized HYUNDAI dealer.

### CAUTION

After checking the fuse box in the engine compartment securely close the fuse box cover inside the engine compartment, until it clicks.

If the fuse box is not closed properly, water may leak in side, possibly causing a malfunction with the electrical system.

### Multi fuse (Main fuse)

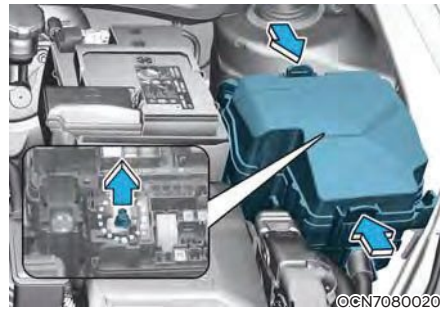

If the multi fuse is blown, it must be removed as follows:

1. Turn off the engine.
2. Disconnect the negative battery cable.
3. Remove the fuse panel cover by pressing the tab and pulling it up.
4. Remove the nuts shown in the picture above.
5. Replace the fuse with a new one of the same rating.
6. Reinstall in the reverse order of removal.

### Information

If the multi fuse is blown, consult an authorized HYUNDAI dealer.

### Fuse/Relay Panel Description Instrument panel fuse panel



Inside the fuse/relay box cover, you can find the fuse/relay label describing fuse/relay names and ratings.

### **i** Information

Not all fuse panel descriptions in this manual may be applicable to your vehicle; the information is accurate at the time of printing. When you inspect the fuse box on your vehicle, refer to the fuse box label.

\* HYBRID MODEL ONLY.

				MEMORY	AIR BAG	A/C	MODULE	MODULE	START
				E-CALL	BATTERY MANAGEMENT		CLUSTER	IBU	A/C
TRUNK	S/HEATER FRT	P/WINDOW LH	MULTI MEDIA	SPARE			FCA	MDPS	MODULE
S/HEATER RR	SAFETY P/WINDOW DRV	P/WINDOW RH	BRAKE SWITCH	IBU	MODULE	AIR BAG		MODULE	SPARE
	AMP	HEATED MIRROR	LOCK LOCK	IAU		MODULE	A/BAG IND		WASHER
P/SEAT PASS	P/SEAT DRV	WIPER	MODULE	SUN ROOF	USB CHARGER	IG1			

USE THE DESIGNATED FUSE ONLY  
USE SOLO LOS FUSIBLES ESPECIFICADOS. P/NO: 91990-AA020  
UTILISEZ SEULEMENT LE FUSIBLE DÉSIGNÉS

OCN7N090001N

## Driver's side fuse panel

Fuse Name	Fuse Rating	Circuit Protected
MEMORY1	10A	Instrument Cluster, A/C Controller, A/C Control Module, DRV/PASS Folding Outside Mirror
AIR BAG2	10A	SRS Control Module
MODULE4	10A	Lane Keeping Assist Unit (LINE), Crash Pad Switch, IBU, Parking Collision Avoidance Assist Unit, A/T Shift Lever Indicator, Front Console Switch
MODULE7	7.5A	Parking Collision Avoidance Assist Unit, IAU, Cooling fan controller (N Line only), Rear Seat Warmer Control Module
START	7.5A	Burglar Alarm Relay, Transaxle Range Switch, PCM/ECMIBU, E/R Junction Block (Start Relay) (Smartstream G 2.0 Atkinson only)
CLUSTER	7.5A	Instrument Cluster
IBU2	7.5A	IBU
A/C1	7.5A	E/R Junction Block (PTC Heater Relay, Blower Relay), A/C Control Module, A/C Controller
TRUNK	10A	Trunk Relay, Trunk lid Latch
S/HEATER FRT	20A	Front Seat Warmer Control Module
P/WINDOW LH	25A	Power Window Main Switch
MULTIMEDIA	15A	Audio, A/V & Navigation Head Unit, DC-DC Converter (Smartstream G 2.0 Atkinson ISG only)
FCA	10A	Forward Collision Avoidance Assist Unit
MDPS	7.5A	MDPS Unit
MODULE6	7.5A	IBU
S/HEATER RR	20A	Rear Seat Warmer Control Module
SAFETY P/ WINDOW DRV	25A	Driver Safety Power Window Module
P/WINDOW RH	25A	Power Window Main Switch, Passenger Power Window Switch
BRAKE SWITCH	10A	Stop Lamp Switch, IBU
IBU1	15A	IBU



**Driver's side fuse panel**

Fuse Name	Fuse Rating	Circuit Protected
MODULE2	10A	E/R Junction Block (Power Outlet Relay), AMP, IBU, IAU, Audio, Power Outside Mirror Switch, Parking Collision Avoidance Assist Unit, DC-DC Converter (Smartstream G 2.0 Atkinson ISG only), A/V & Navigation Head Unit
AIR BAG1	15A	SRS Control Module, Passenger Occupant Detection Sensor
MODULE5	10A	A/T Shift Lever Indicator, Front Wireless Charger, A/C Controller, Electro Chromic Mirror, A/C Control Module, Audio, A/V & Navigation Head Unit, AMP, DC-DC Converter (Smartstream G 2.0 Atkinson ISG only), Data Link Connector, Rear Seat Warmer Control Module, Front Seat Warmer Control Module
AMP	25A	AMP, DC-DC Converter (Smartstream G 2.0 Atkinson ISG only)
HEATED MIRROR	10A	DRV/PAS Outside Mirror Heated, A/C Control Module, A/C Controller, ECU (N Line only)
DOOR LOCK	20A	DRV/PAS DOOR ACTUATOR
IAU	10A	BLE Unit, IAU, Driver/Passenger Door NFC Module
MODULE3	7.5A	Sport Mode Switch, Stop Lamp Switch, IAU
A/BAG IND	7.5A	Instrument Cluster, Overhead Console Lamp
WASHER	15A	Multifunction Switch
P/SEATPASS	30A	Passenger Seat motor
P/SEATDRV	30A	Passenger Seat motor
WIPER	10A	PCM/ECM, IBU
MODULE1	10A	Driver/Passenger Smart Key Outside Handle, Crash Pad Switch, Sport Mode Switch, Data Link Connector, Hazard Switch, Key Solenoid
SUNROOF	20A	Sunroof Motor
USBCHARGER	15A	Front USB Charger
IG1	25A	PCB Block (Fuse - ABS3, ECU5, EOP2, TCU2)



**Engine compartment fuse panel**

Type	Fuse Name	Fuse Rating	Circuit Protected
MULTI FUSE-3	ALT	150A 180A	[Smartstream G 2.0 Atkinson with AMS2] Alternator, (Fuse - ABS1, ABS2, EOP1, POWER OUTLET1) [Smartstream G 2.0 Atkinson & Smartstream G1.6 T-GDi without AMS2] Alternator, (Fuse - ABS1, ABS2, POWER OUTLET1)
	MDPS1	80A	MDPS Unit
MULTI FUSE-2	COOLING FAN2	60A	[G4FP] Cooling Fan Controller
	DCT3	40A	[G4FP] SGA
MULTI FUSE-1	B+5	60A	PCB Block (Engine Control Relay, Fuse - ECU3, ECU4, HORN, WIPER, A/C)
	B+1	60A	ICU Junction Block (IPS2/IPS5/IPS6/IPS7/IPS14)
	B+2	60A	ICU Junction Block (IPS1/IPS4/IPS8/IPS9/IPS10)
	B+3	50A	ICU Junction Block (Fuse - TRUNK, AMP, SAFETY P/WINDOW DRV, P/SEAT DRV, P/SEAT PASS, S/HEATER FRT, S/HEATER RR, Long Term Load Latch Relay)
	EPB	60A	ESC Control Module
	PTC HEATER	50A	PTC HEATER
	BLOWER	40A	BLOWER, Multipurpose Check Connector
	IG1	40A	E/R Junction Block (PDM (IG1/ACC) Relay), Ignition Switch
IG2	40A	E/R Junction Block (PDM (IG2) Relay, Start Relay), Ignition Switch	

### Engine compartment fuse panel

Type	Fuse Name	Fuse Rating	Circuit Protected
FUSE	POWER OUTLET2	20A	Front Power Outlet
	POWER OUTLET3	20A	Not Used
	COOLING FAN1	40A	Cooling Fan (Smartstream G 2.0 Atkinson only)
	DCT1	40A	[G4FP] TCM
	DCT2	40A	[G4FP] TCM
	REAR HEATED	40A	Rear glass heated
	B+4	40A	ICU Junction Block (Fuse - AIR BAG2, IBU1, BRAKE SWITCH, DOOR LOCK, IAU, MODULE1, SUNROOF, Power Window Relay)
	AMS	10A	Battery Sensor
	TCU1	10A	[DCT] TCM, [M/T] Ignition Lock
	FUEL PUMP	20A	Fuel Pump Control Module (T-GDI), Fuel Pump Motor (NU MPI AKS)
	CVVD	40A	[G4FP] CVVD Actuator
	ABS1	40A	ABS Control Module, ESC Control Module, Multipurpose Check Connector
	ABS2	30A	ABS Control Module, ESC Control Module, Multipurpose Check Connector
	EOP1	30A	Electronic Oil Pump (Smartstream G 2.0 Atkinson ISG only)
POWER OUTLET1	40A	P/OUTLET FRT	

**Engine compartment fuse panel**

Fuse Name	Fuse Rating	Circuit Protected
WIPER	25A	Wiper Motor
ECU4	15A	PCM/ECM
A/C	10A	[G4FM] A/C Compressor (Smartstream G 2.0 Atkinson only)
HORN	15A	Horn
IGN COIL	20A	Ignition Coil #1~#4
ECU3	15A	PCM/ECM
SENSOR3	10A	E/R Junction Block (Fuel Pump Relay)
ECU2	10A	PCM/ECM (Smartstream G1.6 T-GDi only)
SENSOR2	10A	[G4NS] Variable Intake Solenoid Valve, Oil Pump Solenoid Valve, Oil Control Valve #1/#2, Canister Close Valve, Purge Control Solenoid Valve, PCB Block (A/C Relay), E/R Junction Block (Cooling Fan1/2 Relay) [G4FP] Variable Oil Pump Solenoid, Oil Control Valve #1/#2, Purge Control Solenoid Valve, RCV Control Solenoid Valve, Canister Close Valve
ECU5	10A	CVVD Actuator (Smartstream G1.6 T-GDi only), ECM/PCM, Ignition Lock
SENSOR1	15A	Oxygen Sensor (UP/DOWN)
ABS3	10A	ABS Control Module, ESC Control Module, Multipurpose Check Connector
INJECTOR	15A	[G4FM/G4FG/G4NA] Injector #1~#4 (Smartstream G 2.0 Atkinson only)
ECU1	20A	PCM/ECM
TCU2	15A	Transaxle Range Switch, [G4FP] TCM (Smartstream G1.6 T-GDi & DCT only)

## LIGHT BULBS

Consult an authorized HYUNDAI dealer to replace most vehicle light bulbs. It is difficult to replace vehicle light bulbs because other parts of the vehicle must be removed before you can get to the bulb. This is especially true for removing the headlamp assembly to get to the bulb(s).

Removing/installing the headlamp assembly can result in damage to the vehicle.

### **i** Information

The headlamp and tail lamp lenses could appear frosty if the vehicle is washed after driving or the vehicle is driven at night in wet weather. This condition is caused by temperature difference between the lamp inside and outside and does not indicate a problem with your vehicle. When moisture condenses in the lamp, it will be removed after driving with the headlamp on. The removable level may differ depending on lamp size, lamp position and environmental condition. However, if moisture is not removed, have the vehicle inspected by an authorized HYUNDAI dealer.

### **⚠** WARNING

- Prior to replacing a lamp, depress the foot brake, move the shift button into P (Park) apply the parking brake, place the ignition switch to the LOCK/OFF position, and take the key with you when leaving the vehicle to avoid sudden movement of the vehicle and to prevent possible electric shock.
- Be aware the bulbs may be hot and may burn your fingers.
- When the bulb is disconnected or the lamp connector is removed while the lamp is operating normally, the fuse box electronics may recognize the lamp as a malfunction. Therefore, a fault record for the lamp may remain in the Diagnostic Trouble Code (DTC) recorded in the fuse box.

### Headlamp, Parking Lamp, Daytime Running Light, Turn Signal Lamp and Side Marker

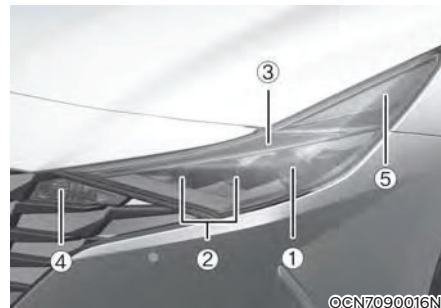
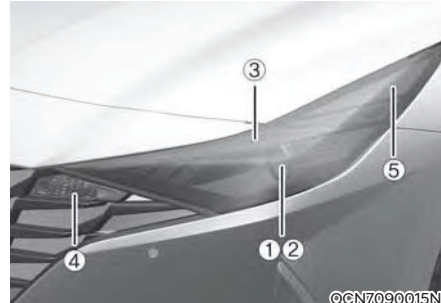

- (1) Headlamp (Low)
- (2) Headlamp (High)
- (3) Daytime running lamp (DRL)/ Parking lamp
- (4) Turn signal lamp
- (5) Side marker



OLMB073042L

### Headlamp (Halogen bulb)

#### **WARNING**

- **Handle halogen bulbs with care. Halogen bulbs contain pressurized gas that will produce flying pieces of glass that could cause injuries if broken.**
- **Wear eye protection when changing a bulb. Allow the bulb to cool down before handling it.**
- Always handle them carefully, and avoid scratches and abrasions. If the bulbs are lit, avoid contact with liquids.
- Never touch the glass with bare hands. Residual oil may cause the bulb to overheat and burst when lit.
- A bulb should be operated only when installed in a headlamp.
- If a bulb becomes damaged or cracked, replace it immediately and carefully dispose of it.

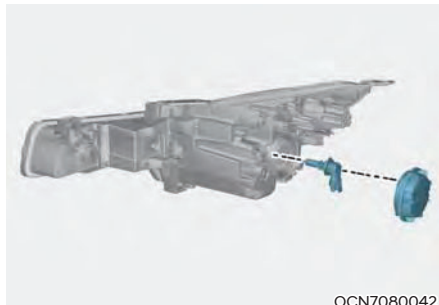

OCN7080042

1. Open the hood.
2. Disconnect the negative battery cable.
3. Remove the headlamp bulb cover by turning it counterclockwise.
4. Disconnect the headlamp bulb socket-connector.
5. Unsnap the headlamp bulb retaining wire by pressing the end and pushing it upward.
6. Remove the bulb from the headlamp assembly.
7. Install a new headlamp bulb and snap the headlamp bulb retaining wire into position by aligning the wire with the groove on the bulb.
8. Connect the headlamp bulb socket-connector.
9. Install the headlamp bulb cover by turning it clockwise.

#### **Information**

**The headlamp aiming should be adjusted after an accident or after the headlamp assembly is reinstalled at an authorized HYUNDAI dealer.**

**Headlamp/Daytime running light (DRL) /  
Parking lamp (LED type)**

If the lamp (LED) does not operate, have the system checked by an authorized HYUNDAI dealer.

The LED lamps cannot be replaced as a single unit because it is an integrated unit. The LED lamps have to be replaced with the unit.

A skilled technician should check or repair the LED lamp, for it may damage related parts of the vehicle.

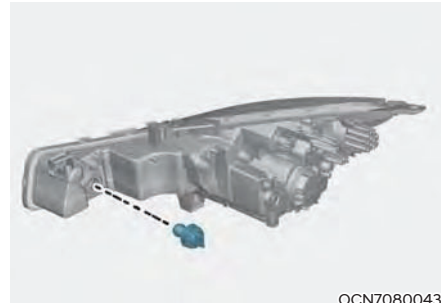

OCN7080043

**Turn signal lamp (Bulb type)**

1. Open the hood.
2. Disconnect the negative battery cable.
3. Remove the socket from the assembly by turning the socket counterclockwise until the tabs on the socket align with the slots on the assembly.
4. Remove the bulb from the socket by pressing it in and rotating it counterclockwise until the tabs on the bulb align with the slots in the socket. Pull the bulb out of the socket.
5. Insert a new bulb by inserting it into the socket and rotating it until it locks into place.
6. Install the socket in the assembly by aligning the tabs on the socket with the slots in the assembly.
7. Push the socket into the assembly and turn the socket clockwise.



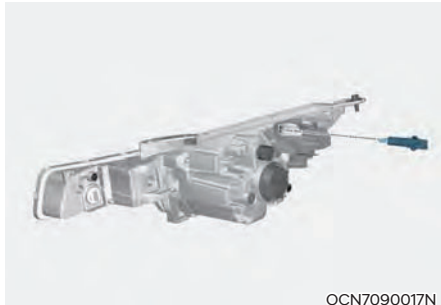

**Side marker (Bulb type)**

1. Open the hood.
2. Disconnect the negative battery cable.
3. Remove the socket from the assembly by turning the socket counterclockwise until the tabs on the socket align with the slots on the assembly.
4. Remove the bulb from the socket by pulling out the bulb.
5. Insert a new bulb.

**Side marker (LED type)**

If the LED lamp does not operate, have the vehicle checked by an authorized HYUNDAI dealer.

**Side repeater lamp replacement (if equipped)**



If the LED lamp (1) does not operate, have the vehicle checked by an authorized HYUNDAI dealer.

**Bulb type**

1. Remove the lamp assembly from the vehicle by prying the lens and pulling the assembly out.
2. Disconnect the bulb electrical connector.
3. Separate the socket and the lens parts by turning the socket counterclockwise until the tabs on the socket align with the slots on the lens part.
4. Remove the bulb by pulling it straight out.
5. Insert a new bulb in the socket.
6. Reassemble the socket and the lens part.
7. Connect the bulb electrical connector.
8. Reinstall the lamp assembly to the body of the vehicle.

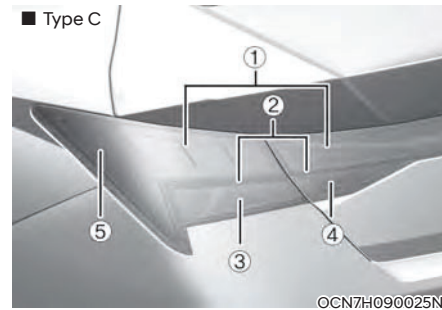
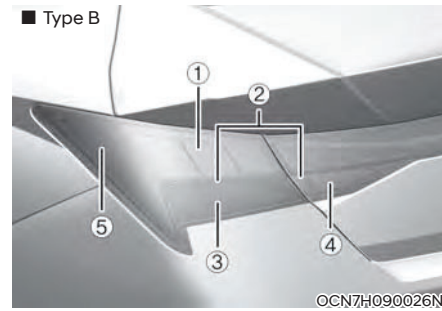
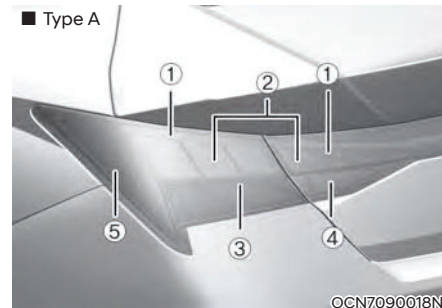
**Rear combination lamp bulb replacement**

- (1) Stop lamp (LED or bulb)
- (2) Tail lamp (LED or bulb)
- (3) Turn signal lamp
- (4) Reverse lamp
- (5) Rear side marker (LED or bulb)

**Tail/Stop lamp/Turn signal lamp/  
Side marker (Outer lamp) (Bulb type)**

1. Open the trunk lid.



2. Remove the service cover by pulling out the service cover.



3. Loosen the assembly retaining nuts.



4. Remove the rear combination light assembly from the body of the vehicle.

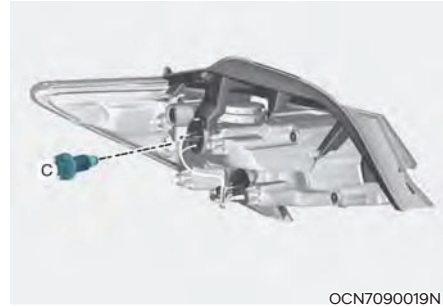
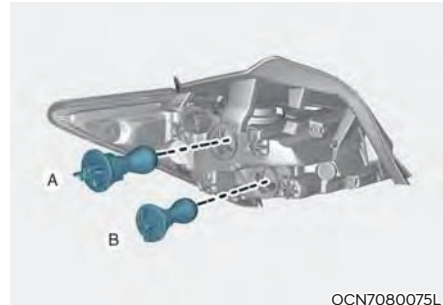

[A] : Tail/Stop lamp, [B] : Turn signal lamp,  
[C] : Rear side marker

5. Remove the socket from the assembly by turning the socket counterclockwise until the tabs on the socket align with the slots on the assembly.
6. Remove the bulb from the socket by pressing it in and rotating it counterclockwise until the tabs on the bulb align with the slots in the socket. Pull the bulb out of the socket.
7. Insert a new bulb by inserting it into the socket and rotating it until it locks into place.
8. Install the socket in the assembly by aligning the tabs on the socket with the slots in the assembly. Push the socket into the assembly and turn the socket clockwise.

### **Tail lamp/Stop lamp (Inner lamp) (Bulb type)**

1. Open the trunk.
2. Loosen the retaining screw of the trunk lid cover and then remove the cover.

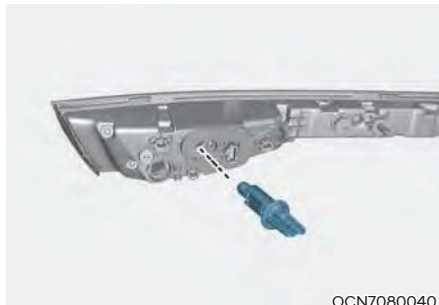

3. Remove the socket from the assembly by turning the socket counterclockwise until the tabs on the socket align with the slots on the assembly.
4. Remove the bulb by pulling it out.
5. Insert a new bulb by inserting it into the socket.
6. Reinstall the trunk lid cover by pushing in the screw.

### **Reverse lamp (Inner lamp) (Bulb type)**

1. Disconnect the connector and then remove the nuts by turning the nuts counter clockwise.
2. Take the light assembly out.

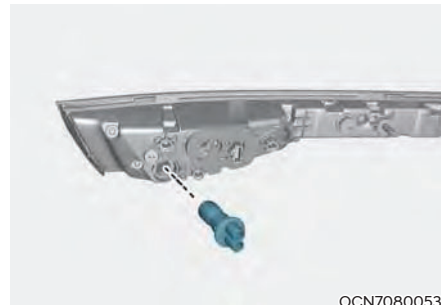

3. Remove the socket from the assembly by turning the socket counterclockwise until the tabs on the socket align with the slots on the assembly.
4. Remove the bulb by pulling it out.
5. Insert a new bulb by inserting it into the socket.
6. Install the light assembly to the trunk.
7. Reinstall the trunk lid cover by pushing in the screw.

### **Stop/Tail lamp and rear side marker (LED type)**

If the LED lamp does not operate, we recommend that you have the vehicle checked by an authorized HYUNDAI dealer.

### High mounted stop lamp replacement

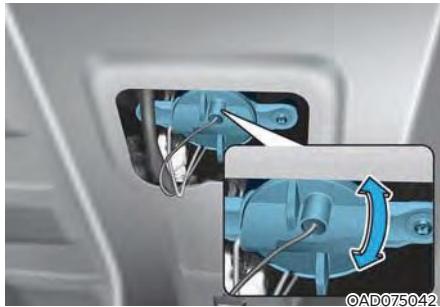
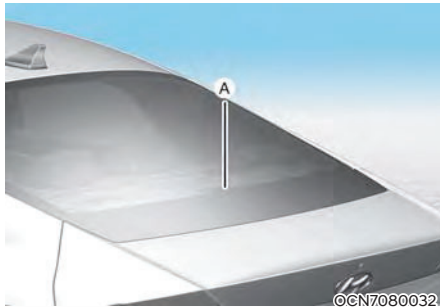

[A] : High mounted stop lamp

1. Open the trunk.
2. Remove the socket by turning it counterclockwise until the tabs on the socket align with the slots.
3. Remove the bulb from the socket by pressing it in and rotating it counterclockwise until the tabs on the bulb align with the slots in the socket. Pull the bulb out of the socket.
4. Insert a new bulb by inserting it into the socket and rotating it until it locks into place.
5. Install the socket in the assembly by aligning the tabs on the socket with the slots in the assembly.  
Push the socket into the assembly and turn the socket clockwise.

### License Plate Light Bulb Replacement



1. Using a flat-blade screwdriver gently pry the lens cover from the lamp housing.
2. Remove the bulb by pulling it straight out.
3. Install a new bulb.
4. Reinstall in the reverse order.

## Interior Light Bulb Replacement

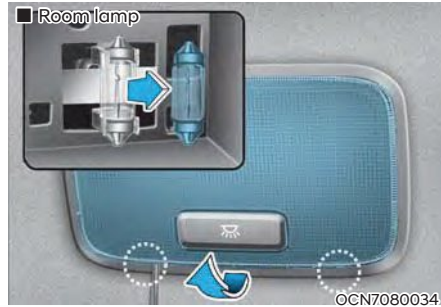
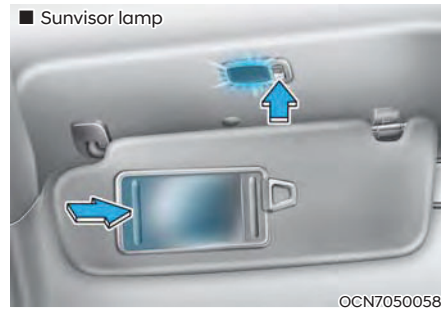
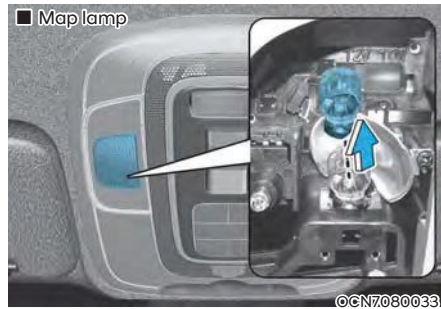

1. Using a flat-blade screwdriver, gently pry the lens from the interior lamp housing.
2. Remove the bulb by pulling it straight out.

### **WARNING**

Prior to working on the Interior Lights, ensure that the “OFF” button is depressed to avoid burning your fingers or receiving an electric shock.

3. Install a new bulb in the socket.
4. Align the lens tabs with the interior lamp housing notches and snap the lens into place.

### **NOTICE**

Use care not to dirty or damage lens, lens tab, and plastic housings.

## APPEARANCE CARE

### Exterior Care

#### **Exterior general caution**

It is very important to follow the label directions when using any chemical cleaner or polish. Read all warning and caution statements that appear on the label.

#### **High-pressure washing**

- When using high-pressure washers, make sure to maintain sufficient distance from the vehicle. Insufficient clearance or excessive pressure can lead to component damage or water penetration.
- Do not spray the camera, sensors or its surrounding area directly with a high pressure washer. Shock applied from high pressure water may cause the device to not operate normally.
- Do not bring the nozzle tip close to boots (rubber or plastic covers) or connectors as they may be damaged if they come into contact with high pressure water.
- Do not use any high-pressure nozzles, which induce either one-direct water stream or water swirling.

### **Protecting your vehicle's finish**

#### **Washing**

To help protect your vehicle's finish from rust and deterioration, wash it thoroughly and frequently at least once a month with lukewarm or cold water.

If you use your vehicle for off-road driving, you should wash it after each off-road trip. Pay special attention to the removal of any accumulation of salt, dirt, mud, and other foreign materials. Make sure the drain holes in the lower edges of the doors and rocker panels are kept clear and clean.

Insects, tar, tree sap, bird droppings, industrial pollution and similar deposits can damage your vehicle's finish if not removed immediately.

Even prompt washing with plain water may not completely remove all these deposits. A mild soap, safe for use on painted surfaces, should be used.

After washing, rinse the vehicle thoroughly with lukewarm or cold water. Do not allow soap to dry on the finish.

#### **High-pressure washing**

- When using high-pressure washers, make sure to maintain sufficient distance from the vehicle. Insufficient clearance or excessive pressure can lead to component damage or water penetration.
- Do not spray the camera, sensors or its surrounding area directly with a high pressure washer. Shock applied from high pressure water may cause the device to not operate normally.
- Do not bring the nozzle tip close to boots (rubber or plastic covers) or connectors as they may be damaged if they come into contact with high pressure water.

**⚠ WARNING**

After washing the vehicle, test the brakes while driving slowly to see if they have been affected by water before getting on the road. If braking performance is impaired, dry the brakes by applying them lightly while maintaining a slow forward speed.

**NOTICE**

- Do not use strong soap, chemical detergents or hot water, and do not wash the vehicle in direct sunlight or when the body of the vehicle is warm.
- Be careful when washing the side windows of your vehicle.  
Especially, with high-pressure water, water may leak through the windows and wet the interior.
- To prevent damage to the plastic parts, do not clean with chemical solvents or strong detergents.

**NOTICE**

- Water washing in the engine compartment including high pressure water washing may cause the failure of electrical circuits located in the engine compartment.
- Never allow water or other liquids to come in contact with electrical/ electronic components inside the vehicle as this may damage them.

**NOTICE**

Matte paint finish vehicle (if equipped)  
Automatic car wash which uses rotating brushes should not be used as this can damage the surface of your vehicle. A steam cleaner which washes the vehicle surface at high temperature may cause oil to adhere and leave stains that is difficult to remove.

Use a soft cloth (e.g. microfiber towel or sponge) when washing your vehicle and dry with a microfiber towel. When you hand wash your vehicle, you should not use a cleaner that finishes with wax. If the vehicle surface is too dirty (sand, dirt, dust, contaminant, etc.), clean the surface with water before washing the car.



### Waxing

A good coat of wax provides a barrier between your paint and environmental contamination.

Keeping a good coat of wax on your vehicle will help protect it.

Wax the vehicle when water will no longer bead on the paint.

Always wash and dry the vehicle before waxing. Use a good quality liquid or paste wax, and follow the manufacturer's instructions. Wax all metal trim to protect it and to maintain its luster.

Removing oil, tar, and similar materials with a spot remover will usually strip the wax from the finish. Be sure to re-wax these areas even if the rest of the vehicle does not yet need waxing.

### NOTICE

- Wiping dust or dirt off the body with a dry cloth will scratch the finish.
- Do not use steel wool, abrasive cleaners, or strong detergents containing highly alkaline or caustic agents on chrome-plated or anodized aluminum parts. This may result in damage to the protective coating and cause discoloration or paint deterioration.

### NOTICE

**Matte paint finish vehicle (if equipped)**

**Do not use any polish protector such as a detergent, an abrasive and a polish. In case wax is applied, remove the wax immediately using a silicon remover and if any tar or tar contaminant is on the surface use a tar remover to clean. However, be careful not to apply too much pressure on the painted area.**

### Repairing your vehicle's finish

Deep scratches or stone chips in the painted surface must be repaired promptly. Exposed metal will quickly rust and may develop into a major repair expense.

### NOTICE

**If your vehicle is damaged and requires any metal repair or replacement, be sure the body shop applies anti-corrosion materials to the parts repaired or replaced.**

### NOTICE

**Matte paint finish vehicle (if equipped)**

**In case of matte paint finish vehicles, it is impossible to modify only the damaged area and repair of the whole part is necessary. If the vehicle is damaged and painting is required, we recommend that you have your vehicle maintained and repaired by an authorized HYUNDAI dealer. Take extreme care, as it is difficult to restore the quality after the repair.**

### Bright-metal maintenance

- To remove road tar and insects, use a tar remover, not a scraper or other sharp object.
- To protect the surfaces of bright metal parts from corrosion, apply a coating of wax or chrome preservative and rub to a high luster.
- During winter weather or in coastal areas, cover the bright metal parts with a heavier coating of wax or preservative. If necessary, coat the parts with non-corrosive petroleum jelly or other protective compound.

### **Underbody maintenance**

Corrosive materials used for ice and snow removal and dust control may collect on the underbody. If these materials are not removed, accelerated rusting can occur on underbody parts such as the fuel lines, frame, floor pan and exhaust system, even though they have been treated with rust protection.

Thoroughly flush the vehicle underbody and wheel openings with lukewarm or cold water once a month, after off-road driving and at the end of each winter. Pay special attention to these areas because it is difficult to see all the mud and dirt. It will do more harm than good to wet down the road grime without removing it. The lower edges of doors, rocker panels, and frame members have drain holes that should not be allowed to clog with dirt; trapped water in these areas can cause rusting.



### **WARNING**

**After washing the vehicle, test the brakes while driving slowly to see if they have been affected by water. If braking performance is impaired, dry the brakes by applying them lightly while maintaining a slow forward speed.**

### **Aluminum wheel maintenance**

The aluminum wheels are coated with a clear protective finish.

#### **NOTICE**

- **Do not use abrasive cleaner, polishing compound, solvent, or wire brushes on aluminum wheels.**
- **Clean the wheel when it has cooled.**
- **Use only a mild soap or neutral detergent, and rinse thoroughly with water. Also, clean the wheels after driving on salted roads.**
- **Do not wash the wheels with high-speed car wash brushes.**
- **Do not use any cleaners containing acid or alkaline detergents.**

### **Corrosion protection**

#### **Protecting your vehicle from corrosion**

By using the most advanced design and construction practices to combat corrosion, HYUNDAI produces vehicles of the highest quality. However, this is only part of the job. To achieve the long-term corrosion resistance your vehicle can deliver, the owner's cooperation and assistance is also required.

#### **Common causes of corrosion**

The most common causes of corrosion on your vehicle are:

- Road salt, dirt and moisture that is allowed to accumulate underneath the vehicle.
- Removal of paint or protective coatings by stones, gravel, abrasion or minor scrapes and dents which leave unprotected metal exposed to corrosion.

#### **High-corrosion areas**

If you live in an area where your vehicle is regularly exposed to corrosive materials, corrosion protection is particularly important. Some of the common causes of accelerated corrosion are road salts, dust control chemicals, ocean air and industrial pollution.

### **Moisture breeds corrosion**

Moisture creates the conditions in which corrosion is most likely to occur. For example, corrosion is accelerated by high humidity, particularly when temperatures are just above freezing. In such conditions, the corrosive material is kept in contact with the car surfaces by moisture that is slow to evaporate.

Mud is particularly corrosive because it is slow to dry and holds moisture in contact with the vehicle. Although the mud appears to be dry, it can still retain the moisture and promote corrosion.

High temperatures can also accelerate corrosion of parts that are not properly ventilated so the moisture can be dispersed. For all these reasons, it is particularly important to keep your vehicle clean and free of mud or accumulations of other materials. This applies not only to the visible surfaces but particularly to the underside of the vehicle.

**To help prevent corrosion***Keep your vehicle clean*

The best way to prevent corrosion is to keep your vehicle clean and free of corrosive materials. Attention to the underside of the vehicle is particularly important.

- If you live in a high-corrosion area — where road salts are used, near the ocean, areas with industrial pollution, acid rain, etc.—, you should take extra care to prevent corrosion. In winter, hose off the underside of your vehicle at least once a month and be sure to clean the underside thoroughly when winter is over.
- When cleaning underneath the vehicle, pay particular attention to the components under the fenders and other areas that are hidden from view. Do a thorough job; just dampening the accumulated mud rather than washing it away will accelerate corrosion rather than prevent it. Water under high pressure and steam are particularly effective in removing accumulated mud and corrosive materials.
- When cleaning lower door panels, rocker panels and frame members, be sure that drain holes are kept open so that moisture can escape and not be trapped inside to accelerate corrosion.

*Keep your garage dry*

Don't park your vehicle in a damp, poorly ventilated garage. This creates a favorable environment for corrosion. This is particularly true if you wash your vehicle in the garage or drive it into the garage when it is still wet or covered with snow, ice or mud. Even a heated garage can contribute to corrosion unless it is well ventilated so moisture is dispersed.

*Keep paint and trim in good condition*

Scratches or chips in the finish should be covered with "touch-up" paint as soon as possible to reduce the possibility of corrosion. If bare metal is showing through, the attention of a qualified body and paint shop is recommended.

Bird droppings are highly corrosive and may damage painted surfaces in just a few hours. Always remove bird droppings as soon as possible.

## Interior Care

### **Interior general precautions**

Prevent caustic solutions such as perfume and cosmetic oil, from contacting the interior parts because they may cause damage or discoloration. If they do contact the interior parts, wipe them off immediately. See the instructions for the proper way to clean vinyl.

#### **NOTICE**

- **Never allow water or other liquids to come in contact with electrical/electronic components inside the vehicle as this may damage them.**
- **When cleaning leather products (steering wheel, seats etc.), use neutral detergents or low alcohol content solutions. If you use high alcohol content solutions or acid/alkaline detergents, the color of the leather may fade or the surface may get stripped off.**

### **Cleaning the upholstery and interior trim**

#### **Vinyl (if equipped)**

Remove dust and loose dirt from vinyl with a whisk broom or vacuum cleaner. Clean vinyl surfaces with a vinyl cleaner.

#### **Fabric (if equipped)**

Remove dust and loose dirt from fabric with a whisk broom or vacuum cleaner. Clean with a mild soap solution recommended for upholstery or carpets. Remove fresh spots immediately with a fabric spot cleaner. If fresh spots do not receive immediate attention, the fabric can be stained and its color can be affected. Also, its fire-resistant properties can be reduced if the material is not properly maintained.

#### **NOTICE**

**Using anything but recommended cleaners and procedures may affect the fabric's appearance and fire-resistant properties.**

**Leather (if equipped)**

- Features of seat leather

- Leather is made from the outer skin of an animal, which goes through a special process to be available for use. Since it is a natural product, each part differs in thickness or density.

Wrinkles may appear as a natural result of stretching and shrinking depending on the temperature and humidity.

- The seat is made of stretchable fabric to improve comfort.
- The parts contacting the body are curved and the side supporting area is high which provides driving comfort and stability.
- Wrinkles may appear naturally from usage. It is not a fault of the products.

**CAUTION**

- **Wrinkles or abrasions which appear naturally from usage are not covered by warranty.**
- **Belts with metallic accessories, zippers or keys inside the back pocket may damage the seat fabric.**
- **Make sure not to wet the seat. It may change the nature of natural leather.**
- **Jeans or clothes which could bleach may contaminate the surface of the seat covering fabric.**

- Caring for the leather seats

- Vacuum the seat periodically to remove dust and sand on the seat. It will prevent abrasion or damage of the leather and maintain its quality.
- Wipe the natural leather seat cover often with dry or soft cloth.
- Use of proper leather protector may prevent abrasion of the cover and helps maintain the color. Be sure to read the instructions and consult a specialist when using leather coating or protective agent.
- Light colored (beige, cream beige) leather is easily contaminated and the stain is noticeable. Clean the seats frequently.
- Avoid wiping with wet cloth. It may cause the surface to crack.

- Cleaning the leather seats

- Remove all contaminations instantly. Refer to instructions below for removal of each contaminant.
- Cosmetic products (sunscreen, foundation, etc.)  
Apply cleansing cream on a cloth and wipe the contaminated spot. Wipe off the cream with a wet cloth and remove water with a dry cloth.
- Beverages (coffee, soft drink, etc.)  
Apply a small amount of neutral detergent and wipe until contaminations do not smear.
- Oil  
Remove oil instantly with absorbable cloth and wipe with stain remover used only for natural leather.
- Chewing gum  
Harden the gum with ice and remove gradually.

### ***Cleaning the seat belt webbing***

Clean the belt webbing with any mild soap solution recommended for cleaning upholstery or carpet. Follow the instructions provided with the soap. Do not bleach or re-dye the webbing because this may weaken the seat belt.

### ***Cleaning the interior window glass***

If the interior glass surfaces of the vehicle become hazy (that is, covered with an oily, greasy or waxy film), they should be cleaned with glass cleaner. Follow the directions on the glass cleaner container.

### **NOTICE**

**Do not scrape or scratch the inside of the rear window. This may result in damage to the rear window defroster grid.**

## EMISSION CONTROL SYSTEM

The emission control system of your vehicle is covered by a written limited warranty. Please see the warranty information contained in the Owner's Handbook & Warranty Information booklet in your vehicle.

Your vehicle is equipped with an emission control system to meet all applicable emission regulations. There are three emission control systems, as follows.

- (1) Crankcase emission control system
- (2) Evaporative emission control system
- (3) Exhaust emission control system

In order to ensure the proper function of the emission control systems, it is recommended that you have your vehicle inspected and maintained by an authorized HYUNDAI dealer in accordance with the maintenance schedule in this manual.

### NOTICE

#### For the Inspection and Maintenance Test (with Electronic Stability Control (ESC) system)

- **To prevent the vehicle from misfiring during dynamometer testing, turn the Electronic Stability Control (ESC) system off by pressing the ESC switch (ESC OFF light illuminated).**
- **After dynamometer testing is completed, turn the ESC system back on by pressing the ESC switch again.**

### 1. Crankcase Emission Control System

The positive crankcase ventilation system is employed to prevent air pollution caused by blow-by gases being emitted from the crankcase. This system supplies fresh filtered air to the crankcase through the air intake hose. Inside the crankcase, the fresh air mixes with blow-by gases, which then pass through the PCV valve into the induction system.

### 2. Evaporative Emission Control System Including Onboard Refueling Vapor Recovery (ORVR)

The Evaporative Emission Control System is designed to prevent fuel vapors from escaping into the atmosphere. The ORVR system is designed to allow the vapors from the fuel tank to be loaded into a canister while refueling at the gas station, preventing the escape of fuel vapors into the atmosphere.

#### Canister

Fuel vapors generated inside the fuel tank are absorbed and stored in the onboard canister. When the engine is running, the fuel vapors absorbed in the canister are drawn into the surge tank through the purge control solenoid valve.

#### Purge Control Solenoid Valve (PCSV)

The purge control solenoid valve is controlled by the Engine Control Module (ECM); when the engine coolant temperature is low during idling, the PCSV closes so that evaporated fuel is not taken into the engine. After the engine warms-up during ordinary driving, the PCSV opens to introduce evaporated fuel to the engine.



### 3. Exhaust Emission Control System

The Exhaust Emission Control System is a highly effective system which controls exhaust emissions while maintaining good vehicle performance.

When the engine starts or fails to start, excessive attempts to restart the engine may cause damage to the emission system.

#### **Engine exhaust (carbon monoxide) precautions**

- Carbon monoxide can be present with other exhaust fumes. If you smell exhaust fumes of any kind in your vehicle, drive with all the windows fully open. Have your vehicle checked and repaired immediately.

- Do not operate the engine in confined or closed areas (such as garages) any more than what is necessary to move the vehicle in or out of the area.
- When the vehicle is stopped in an open area for more than a short time with the engine running, adjust the ventilation system (as needed) to draw outside air into the vehicle.
- Never sit in a parked or stopped vehicle for any extended time with the engine running.
- When the engine stalls or fails to start, excessive attempts to restart the engine may cause damage to the emission control system.



#### **WARNING**

Engine exhaust gases contain carbon monoxide (CO). Though colorless and odorless, it is dangerous and could be lethal if inhaled. Follow the instructions on this page to avoid CO poisoning.



#### **WARNING**

##### **CALIFORNIA PROPOSITION 65 WARNING**

Engine exhaust and a wide variety of automobile components and parts, including components found in the interior furnishings in a vehicle, contain or emit chemicals known to the State of California to cause cancer and birth defects and reproductive harm. In addition, certain fluids contained in vehicles and certain products of component wear contain or emit chemicals known to the State of California to cause cancer and birth defects or other reproductive harm.

### ***Operating precautions for catalytic converters (if equipped)***



#### **WARNING**

The exhaust system and catalytic converter are very hot during and immediately after the engine has been running. To avoid **SERIOUS INJURY** or **DEATH**:

- Do not park, idle, or drive the vehicle over or near flammable objects, such as grass, vegetation, paper, leaves, etc. A hot exhaust system can ignite flammable items under your vehicle.
- Keep away from the exhaust system and catalytic converter or you may get burned.

**Also, do not remove the heat sink around the exhaust system, do not seal the bottom of the vehicle, and do not coat the vehicle for corrosion control. It may present a fire risk under certain conditions.**

Your vehicle is equipped with a catalytic converter emission control device.

To prevent damage to the catalytic converter and to your vehicle, take the following precautions:

- Use only UNLEADED FUEL for gasoline engines.
- Do not operate the vehicle when there are signs of engine malfunction, such as misfire or a noticeable loss of performance.
- Do not misuse or abuse the engine. Examples of misuse are coasting with the engine off and descending steep grades in gear with the engine off.
- Do not operate the engine at high idle speed for extended periods (5 minutes or more).
- Do not modify or tamper with any part of the engine or emission control system. All inspections and adjustments must be made by an authorized HYUNDAI dealer.
- Avoid driving with extremely low fuel level. If you run out of gasoline, it could cause the engine to misfire and result in excessive loading of the catalytic converter.

## **CALIFORNIA PERCHLORATE NOTICE**

Perchlorate Material-special handling may apply, See:  
[www.dtsc.ca.gov/hazardouswaste/perchlorate](http://www.dtsc.ca.gov/hazardouswaste/perchlorate).

Notice to California Vehicle Dismantlers:

Perchlorate containing materials, such as air bag inflators, seatbelt pretensioners and keyless remote entry batteries, must be disposed of according to Title 22 California Code of Regulations Section 67384.10 (a).

# Index

---

**A**

Accessing Your Vehicle .....	5-4
Automatic Door Lock and Unlock Features .....	5-35
Child-Protector Rear Door Locks .....	5-35
Hyundai Digital Key .....	5-15
Immobilizer System .....	5-14
Operating Door Locks from Inside the Vehicle.....	5-33
Operating Door Locks from Outside the Vehicle.....	5-31
Rear Occupant Alert (ROA) System .....	5-36
Remote Key.....	5-4
Smart Key.....	5-7
Air Bag - Advanced Supplemental Restraint System.....	3-35
Additional Safety Precautions.....	3-55
Air Bag Warning Labels.....	3-55
How Does the Air Bag System Operate? .....	3-40
Occupant Classification System (OCS) .....	3-44
SRS Care .....	3-54
What to Expect After an Air Bag Inflates .....	3-43
Where Are the Air Bags?.....	3-37
Why Didn't My Air Bag Go Off in a Collision? .....	3-50
Air Cleaner.....	9-22
Filter Replacement .....	9-22
Air Conditioning System.....	2-12
Anti-lock Brake System (ABS) .....	6-44
Electronic Stability Control (ESC) .....	6-46
Good Braking Practices.....	6-49
Hill-Start Assist Control (HAC) .....	6-49
Vehicle Stability Management (VSM) .....	6-48
Appearance Care.....	9-62
Exterior Care .....	9-62
Interior Care .....	9-68
Automatic Climate Control System.....	5-92
Automatic heating and air conditioning.....	5-93
Manual heating and air conditioning.....	5-94
System Maintenance .....	5-102
System operation .....	5-100



---

**B**

Battery .....	9-27
Battery Capacity Label.....	9-28
Battery Recharging.....	9-29
For Best Battery Service .....	9-28
Reset Items .....	9-29
Before Driving .....	6-4
Before Entering the Vehicle .....	6-4
Before Starting .....	6-4
Blind-Spot Collision Warning (BCW) .....	7-37
Function malfunction and limitations .....	7-42
Function operation.....	7-40
Function settings .....	7-38
Blind-Spot Collision-Avoidance Assist (BCA) .....	7-46
Function malfunction and limitations .....	7-55
Function operation.....	7-50
Function settings .....	7-48
Brake System.....	6-34
Auto Hold.....	6-41
Disc Brakes Wear Indicator.....	6-34
Electronic Parking Brake (EPB) .....	6-37
Parking brake.....	6-35
Power Brakes.....	6-34
Brake/Clutch Fluid .....	9-20
Checking the Brake/Clutch Fluid Level.....	9-20
Bulb Wattage.....	2-10

**C**

Cabin Air Filter .....	9-24
Filter Inspection.....	9-24
Filter Replacement .....	9-24
California Perchlorate Notice .....	9-74
Child Restraint System (CRS).....	3-26
Children Always in the Rear .....	3-26
Installing a Child Restraint System (CRS).....	3-28
Selecting a Child Restraint System (CRS).....	3-27
Climate control additional features.....	5-109
Auto comfort control (for driver’s seat).....	5-109
Automatic ventilation.....	5-109
Sunroof inside air recirculation .....	5-109
Consumer Information.....	2-17
Cruise Control (CC) .....	7-74
Function operation .....	7-74

**D**

Declaration of conformity.....	7-146
Dimensions .....	2-9
Drive Mode Integrated Control System.....	
Drive Mode .....	6-54
Smart shift on trip computer .....	6-57
Driver Attention Warning (DAW) .....	7-68
Function malfunction and limitations .....	7-71
Function settings .....	7-68
System operation .....	7-69
Dual clutch transmission.....	6-23
Dual clutch transmission operation.....	6-23
Good driving practices .....	6-32
LCD display for transmission temperature and warning message.....	6-25
Paddle Shifter (Manual Shift Mode) .....	6-30
Parking .....	6-32

**E**

Emission Control System .....	9-71
Engine Compartment.....	2-8/ 9-3
Engine Coolant .....	9-17
Changing Engine Coolant .....	9-19
Checking the Engine Coolant Level.....	9-17
Engine Number.....	2-16
Engine Oil.....	9-15
Checking the Engine Oil and Filter.....	9-16
Checking the Engine Oil Level .....	9-15
Engine specification.....	2-9
Explanation of Scheduled Maintenance Items .....	9-13
Dual clutch transmission fluid .....	9-14
Exterior Lights .....	5-68
Battery saver function .....	5-71
Headlamp delay function .....	5-71
High beam operation .....	5-69
Lighting control.....	5-68
Turn signals and lane change signals .....	5-70
Exterior Overview .....	2-2

**F**

Forward Collision–Avoidance Assist (FCA) (front view camera only) .....	7-2
Function malfunction and limitations .....	7-7
Function operation.....	7-5
Function settings .....	7-3
Forward Collision–Avoidance Assist (FCA) (sensor fusion) .....	7-14
Function malfunction and limitations .....	7-22
Function operation.....	7-18
Function settings .....	7-16
Fuel filler door .....	5-66
Fuel Requirements.....	1-5
Detergent Fuel Additives.....	1-7
Gasoline containing alcohol or methanol.....	1-6
Gasoline containing MMT .....	1-6
Operation in foreign countries.....	1-7
Using Fuel Additives (except Detergent Fuel Additives).....	1-6



Fuses .....	9-43
Engine Compartment Panel Fuse Replacement .....	9-45
Fuse/Relay Panel Description .....	9-46
Instrument Panel Fuse Replacement .....	9-44

## G

Guide to Hyundai Genuine Parts .....	1-3
--------------------------------------	-----

## H

Hazard Warning Flasher .....	8-2
High Beam Assist (HBA) .....	5-72
Detecting sensor (Front view camera) .....	5-72
Function malfunction and limitations .....	5-73
Function operation.....	5-73
Function settings .....	5-72
Highway Driving Assist (HDA) .....	7-106
Function malfunction and limitations .....	7-110
Function operation.....	7-108
Function settings .....	7-107
Hood .....	5-59
How to Use This Manual.....	1-4
Hyundai Motor America.....	1-2

## I

If the engine overheats.....	8-6
If the Engine Will not Start.....	8-3
If the Engine Doesn't Turn Over or Turns Over Slowly .....	8-3
If the Engine Turns Over Normally but Doesn't Start .....	8-3
If you Have a Flat Tire (With spare tire) .....	8-14
Changing Tires .....	8-15
Jack and Tools .....	8-14
Ignition Switch .....	6-5
Engine Start/Stop Button.....	6-8
Key Ignition Switch .....	6-5



---

Important Safety Precautions.....	3-2
Air Bag Hazards .....	3-2
Always Wear Your Seat Belt .....	3-2
Control Your Speed .....	3-2
Driver Distraction.....	3-2
Keep Your Vehicle in Safe Condition.....	3-2
Restrain All Children.....	3-2
In Case of an Emergency While Driving.....	8-2
If the Engine Stalls at a Crossroad or Crossing.....	8-2
If the Engine Stalls While Driving.....	8-2
If you Have a Flat Tire While Driving .....	8-3
Infotainment System.....	5-117
Antenna .....	5-118
Bluetooth® Wireless Technology hands-free.....	5-120
How vehicle radio works.....	5-121
Infotainment system .....	5-120
Steering wheel audio control.....	5-119
USB Port .....	5-117
Voice recognition.....	5-120
Instrument Cluster .....	4-4
Gauges and Meters .....	4-5
Instrument Cluster Control.....	4-5
LCD Display Messages.....	4-19
Transmission shift indicator .....	4-9
Warning and Indicator Lights.....	4-10
Instrument Panel Overview .....	2-7
Intelligent variable transmission.....	6-16
Good driving practices .....	6-22
Intelligent variable transmission operation .....	6-16
Parking .....	6-21
Interior Features.....	5-111
Clock .....	5-116
Clothes Hanger.....	5-116
Cup Holder .....	5-111
Power Outlet.....	5-112
Sunvisor.....	5-112
USB Charger .....	5-113
Wireless Cellular Phone Charging System.....	5-114

Interior Lights .....	5-75
Front lamps.....	5-75
Interior lamp AUTO cut .....	5-75
Luggage compartment lamp.....	5-77
Rear lamp .....	5-76
Vanity mirror lamp .....	5-77
Welcome system.....	5-78
Interior Overview.....	2-6
Introduction .....	1-2
ISG (Idle Stop and Go) system.....	6-50
Battery Sensor Deactivation.....	6-53
ISG System Malfunction.....	6-52
To Activate the ISG System .....	6-50
To Deactivate the ISG System .....	6-52

## J

Jump Starting.....	8-4
--------------------	-----

## L

Lane Following Assist (LFA) .....	7-102
Function malfunction and limitations .....	7-105
Function operation.....	7-103
Function settings .....	7-102
Lane Keeping Assist (LKA) .....	7-30
Function malfunction and limitations .....	7-34
Function operation.....	7-32
Function settings .....	7-30
LCD Display (Type A).....	4-25
LCD Display Control .....	4-25
LCD display modes.....	4-26
Trip Computer .....	4-36
User settings mode .....	4-29
LCD display (Type B) .....	4-40
LCD Display Control .....	4-40
User settings mode .....	4-44
Utility group .....	4-42
View modes.....	4-41



Light Bulbs .....	9-53
Headlamp, Parking Lamp, Daytime Running Light, Turn Signal Lamp and Side Marker .....	9-53
High mounted stop lamp replacement.....	9-60
Interior Light Bulb Replacement.....	9-61
License Plate Light Bulb Replacement .....	9-60
Rear combination lamp bulb replacement.....	9-57
Side repeater lamp replacement .....	9-56

**M**

Maintenance Services .....	9-4
Owner Maintenance Precautions.....	9-4
Owner's Responsibility .....	9-4
Manual Climate Control System .....	5-81
Heating and Air Conditioning .....	5-82
System Maintenance .....	5-90
System operation .....	5-88
Manual Speed Limit Assist (MSLA) .....	7-65
System operation .....	7-65
Manual transmission.....	6-13
Good driving practices .....	6-15
Manual transmission operation .....	6-13
Mirrors .....	5-41
Inside Rearview Mirror .....	5-41
Side View Mirrors .....	5-49

**N**

Navigation-Based Smart Cruise Control (NSCC) .....	7-95
Function operation.....	7-96
Function settings .....	7-95
Limitations of the function.....	7-98

**O**

Owner Maintenance.....	9-5
Owner Maintenance Schedule.....	9-5

**P**

Parking Brake ..... 9-21  
    Checking the Parking Brake..... 9-21

**R**

Rear Cross-Traffic Collision Warning (RCCW) ..... 7-117  
    Function malfunction and limitations ..... 7-121  
    Function operation..... 7-119  
    Function settings ..... 7-118  
Rear Cross-Traffic Collision-Avoidance Assist (RCCA) ..... 7-125  
    Function malfunction and limitations ..... 7-131  
    Function operation..... 7-127  
    Function settings ..... 7-126  
Rear View Monitor (RVM)..... 7-113  
    Function malfunction and limitations ..... 7-116  
    Function operation..... 7-114  
    Function settings ..... 7-114  
Recommended Lubricants and Capacities ..... 2-13  
    Recommended SAE Viscosity Number ..... 2-14  
Reporting Safety Defects ..... 2-18  
Reverse Parking Collision-Avoidance Assist (PCA) ..... 7-138  
    Function malfunction and limitations ..... 7-142  
    Function operation..... 7-141  
    Function settings ..... 7-139  
Reverse Parking Distance Warning (PDW) ..... 7-135  
    Function malfunction and precautions ..... 7-136  
    Function operation..... 7-136

**S**

Safe Exit Warning (SEW) ..... 7-60  
    Function malfunction and limitations ..... 7-63  
    Function operation..... 7-62  
    Function settings ..... 7-61  
Safety Messages..... 1-4  
Scheduled Maintenance Services ..... 9-7  
    Maintenance Under Severe Usage Conditions..... 9-11  
    Normal Maintenance Schedule (Smartstream G2.0 Atkinson) ..... 9-8



---

Seat Belts .....	3-17
Additional Seat Belt Safety Precautions .....	3-23
Care of Seat Belts .....	3-25
Seat Belt Restraint System .....	3-18
Seat Belt Safety Precautions .....	3-17
Seat Belt Warning Light .....	3-18
Seats .....	3-3
Front Seats .....	3-5
Head Restraints .....	3-11
Rear Seats .....	3-10
Safety Precautions .....	3-4
Seat Warmers .....	3-15
Smart Cruise Control (SCC) .....	7-78
Function display and control .....	7-83
Function malfunction and limitations .....	7-88
Function operation .....	7-82
Function settings .....	7-79
Special Driving Conditions .....	6-58
Driving at Night .....	6-59
Driving in Flooded Areas .....	6-60
Driving in the Rain .....	6-59
Hazardous Driving Conditions .....	6-58
Highway Driving .....	6-60
Rocking the Vehicle .....	6-58
Smooth Cornering .....	6-59
Steering Wheel .....	5-38
Electric Power Steering (EPS) .....	5-38
Horn .....	5-40
Tilt Steering / Telescope Steering .....	5-39
Storage compartment .....	5-110
Center console storage .....	5-110
Glove box .....	5-110
Sunroof .....	5-55
Resetting the sunroof .....	5-58
Sunroof open warning .....	5-58
Sunroof opening and closing .....	5-56
Sunshade .....	5-57
Tilting the sunroof .....	5-57

**T**

Tire Pressure Monitoring System (TPMS) .....	8-8
Changing a tire with TPMS.....	8-12
Check tire pressure.....	8-8
Low tire pressure position and tire pressure telltale.....	8-10
Low tire pressure telltale .....	8-10
Tire pressure monitoring system .....	8-9
TPMS (Tire Pressure Monitoring System) malfunction indicator .....	8-12
Tire Specification and Pressure Label .....	2-16
Tires and Wheels .....	2-11/ 9-30
All Season Tires .....	9-41
Check Tire Inflation Pressure.....	9-31
Low Aspect Ratio Tires.....	9-42
Radial-Ply Tires.....	9-41
Recommended Cold Tire Inflation Pressures.....	9-30
Snow Tires.....	9-41
Summer Tires .....	9-41
Tire Care.....	9-30
Tire Maintenance.....	9-35
Tire Replacement .....	9-33
Tire Rotation.....	9-32
Tire Sidewall Labeling .....	9-35
Tire Terminology and Definitions .....	9-38
Tire Traction .....	9-35
Wheel Alignment and Tire Balance .....	9-33
Wheel Replacement.....	9-35
Towing.....	8-20
Emergency towing.....	8-22
Emergency Towing .....	8-21
Removable towing hook.....	8-21
Towing Service.....	8-20
Trailer Towing .....	6-69
Trunk.....	5-61
Emergency trunk safety release.....	5-62
Smart Trunk release.....	5-63

**V**

Vehicle Break-In Process .....	1-7
Vehicle Certification Label .....	2-15
Vehicle Data Collection and Event Data Recorders .....	1-8
Vehicle Identification Number (VIN) .....	2-15
Vehicle load limit .....	6-64
Tire Loading Information Label .....	6-65
Vehicle Modifications .....	1-7
Volume and Weight .....	2-12

**W**

Washer Fluid .....	9-21
Checking the Washer Fluid Level .....	9-21
Windows .....	5-51
Power Windows .....	5-52
Windshield defrosting and defogging .....	5-104
Auto defogging system (only for automatic climate control system) .....	5-107
Automatic climate control system .....	5-105
Defogging logic .....	5-106
Defroster .....	5-108
Manual climate control system .....	5-104
Winter Driving .....	6-61
Snow or Icy Conditions .....	6-61
Winter Precautions .....	6-63
Wiper Blades .....	9-25
Blade Inspection .....	9-25
Blade Replacement .....	9-25
Wipers and Washers .....	5-79
Windshield Washers .....	5-80
Windshield Wipers .....	5-79