



NG90-EU12B  
(영어 | 미국)

# GENESIS G70

GENESIS G70 | 2022 | 2022

2022 OWNER'S MANUAL



“ For clean future, Genesis Branded Vehicle use environmentally friendly paper to produce owner's manual.”

2022 OWNER'S MANUAL



GENESIS



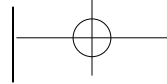

### WARRANTIES FOR YOUR GENESIS BRANDED VEHICLE

Please consult your Owner's Handbook & Warranty Information booklet for your vehicle's specific warranty coverage.

### RESPONSIBILITY FOR MAINTENANCE

The maintenance requirements for your new Genesis Branded Vehicle are found in Section 9. As the owner, it is your responsibility to see that all maintenance operations specified by the manufacturer are carried out at the appropriate intervals. When the vehicle is used in severe driving conditions, more frequent maintenance is required for some operations. Maintenance requirements for severe operating conditions are also included in Section 9.

### WARNING – California Proposition 65

“Operating, servicing and maintaining a passenger vehicle or off- road vehicle can expose you to chemicals including engine exhaust, carbon monoxide, phthalates, and lead, which are known to the State of California to cause cancer and birth defects or other reproductive harm. To minimize exposure, avoid breathing exhaust, do not idle the engine except as necessary, service your vehicle in a well-ventilated area and wear gloves or wash your hands frequently when servicing your vehicle. For more information go to [www.P65Warnings.ca.gov/passenger-vehicle](http://www.P65Warnings.ca.gov/passenger-vehicle).”

This Owner's Manual should be considered a part of the car and remain with it when it is sold for the use of the next owner.

### OWNER'S INFORMATION

ORIGINAL OWNER

ADDRESS \_\_\_\_\_

CITY \_\_\_\_\_ STATE \_\_\_\_\_ ZIP CODE \_\_\_\_\_

DELIVERY DATE \_\_\_\_\_

(Date Sold to Original Retail Purchaser)

DEALER NAME \_\_\_\_\_ DEALER NO. \_\_\_\_\_

ADDRESS \_\_\_\_\_

CITY \_\_\_\_\_ STATE \_\_\_\_\_ ZIP CODE \_\_\_\_\_

# OWNER'S MANUAL

Operation  
Maintenance  
Specifications

All information in this Owner's Manual is current at the time of publication. However, Genesis reserves the right to make changes at any time so that our policy of continual product improvement may be carried out.

This manual applies to all Genesis Branded Vehicle models and includes descriptions and explanations of optional as well as standard equipment.

As a result, you may find material in this manual that does not apply to your specific vehicle.

---

## **CAUTION: MODIFICATIONS TO YOUR GENESIS BRANDED VEHICLE**

Your Genesis Branded Vehicle should not be modified in any way. Such modifications may adversely affect the performance, safety or durability of your Genesis Branded Vehicle and may, in addition, violate conditions of the limited warranties covering the vehicle. Certain modifications may also be in violation of regulations established by the U.S. Department of Transportation and other federal or state agencies.

## **TWO-WAY RADIO OR CELLULAR TELEPHONE INSTALLATION**

Your vehicle is equipped with electronic fuel injection and other electronic components. It is possible for an improperly installed/adjusted two-way radio or cellular telephone to adversely affect electronic systems. For this reason, we recommend that you carefully follow the radio manufacturer's instructions or consult your authorized retailer of Genesis Branded products for precautionary measures or special instructions if you choose to install one of these devices.

---

## SAFETY AND VEHICLE DAMAGE WARNING

This manual includes information titled as DANGER, WARNING, CAUTION and NOTICE.

These titles indicate the following:



### **DANGER**

**DANGER** indicates a hazardous situation which, if not avoided, will result in death or serious injury.



### **WARNING**

**WARNING** indicates a hazardous situation which, if not avoided, could result in death or serious injury.



### **CAUTION**

**CAUTION** indicates a hazardous situation which, if not avoided, could result in minor or moderate injury.

### **NOTICE**

**NOTICE** indicates a situation which, if not avoided, could result in vehicle damage.

## GENESIS BRANDED VEHICLE OWNER PRIVACY POLICY

Your Genesis Branded Vehicle may be equipped with technologies and services that use information collected, generated, recorded or stored by the vehicle. Genesis Branded Vehicle has created a Vehicle Owner Privacy Policy to explain how these technologies and services collect use and share this information.

You may read our Vehicle Owner Privacy Policy at [HYPERLINK "http://www.genesis.com/us/en/my-privacy-rights.html#owner"](http://www.genesis.com/us/en/my-privacy-rights.html#owner).

If you would like to receive a hard copy of our Vehicle Owner Privacy Policy, please contact our Genesis Customer Care at:

Genesis Customer Care  
PO BOX 20650  
Fountain Valley, CA 92728  
844-340-9741

Genesis Customer Care Center representatives are available Monday through Friday between the hours of 5:00 AM and 5:00 PM PST and Saturday between 6:30 AM and 3:00 PM PST (English)

For Genesis Customer Care assistance in Spanish or Korean, representatives are available Monday through Friday between 6:30 AM and 3:00 PM PST.

## Table of Contents

Introduction	1
Vehicle Information, Consumer Information and Reporting Safety Defects	2
Safety System	3
Instrument Cluster	4
Convenient Features	5
Driving Your Vehicle	6
Driver Assistance System	7
Emergency Situations	8
Maintenance	9
Index	I

# 1. Introduction

Introduction.....	1-2
Genesis Customer Care.....	1-2
Guide to Genesis Parts .....	1-3
How to Use this Manual .....	1-4
Safety Messages .....	1-4
Fuel Requirements.....	1-5
Gasoline containing alcohol and methanol .....	1-5
Using Fuel Additives (except Detergent Fuel Additives).....	1-6
Gasoline containing MMT .....	1-6
Detergent Fuel Additives.....	1-6
Operation in foreign countries.....	1-6
Vehicle Modifications .....	1-7
Vehicle Break-in Process.....	1-7
Vehicle Data Collection and Event Data Recorders .....	1-8



## INTRODUCTION

Congratulations, and thank you for choosing this Genesis Branded Vehicle. We are pleased to welcome you to the growing number of discerning people who drive the Genesis Branded Vehicle. We are very proud of the advanced engineering and high-quality construction of each Genesis Branded Vehicle we build.

Your Owner's Manual will introduce you to the features and operation of your new Genesis Branded Vehicle. To become familiar with your new Genesis Branded Vehicle, so that you can fully enjoy it, read this Owner's Manual carefully before driving your new vehicle.

This manual contains important safety information and instructions intended to familiarize you with your vehicle's controls and safety features so you can safely operate your vehicle.

This manual also contains information on maintenance designed to enhance safe operation of the vehicle. It is recommended that all service and maintenance on your car be performed by an authorized retailer of Genesis Branded products. Retailers of Genesis Branded products are prepared to provide high-quality service, maintenance and any other assistance that may be required.

This Owner's Manual should be considered a permanent part of your vehicle, and should be kept in the vehicle so you can refer to it at any time. The manual should stay with the vehicle if you sell it to provide the next owner with important operating, safety and maintenance information.

## GENESIS CUSTOMER CARE



### CAUTION

**Severe engine and transmission damage may result from the use of poor quality fuels and lubricants that do not meet Genesis Branded Vehicle specifications. You must always use high quality fuels and lubricants that meet the specifications listed on Page 2-12 in the Vehicle Specifications section of the Owner's Manual.**

Copyright 2021 Genesis Customer Care. All rights reserved. No part of this publication may be reproduced, stored in any retrieval system or transmitted in any form or by any means without the prior written permission of Genesis Customer Care.

## GUIDE TO GENESIS PARTS

### 1. What are Genesis Parts?

Genesis Parts are the same parts used by HYUNDAI Motor Company to manufacture vehicles. They are designed and tested for the optimum safety, performance, and reliability to our customers.



### 2. Why should you use Genesis Parts?

Genesis Parts are engineered and built to meet rigid manufacturing requirements. Damage caused by using imitation, counterfeit or used salvage parts is not covered under the Genesis Branded New Vehicle Limited Warranty or any other Genesis Branded Vehicle warranty.

In addition, any damage to or failure of Genesis Part caused by the installation or failure of an imitation, counterfeit or used salvage part is not covered by any Genesis Branded Vehicle Warranty.

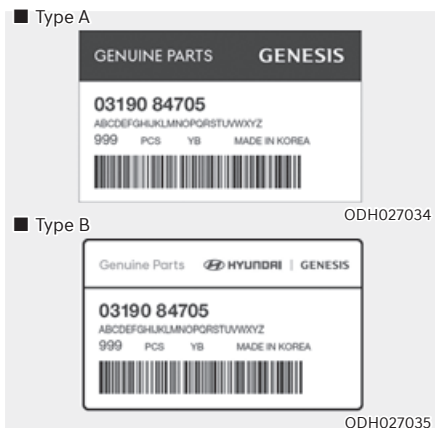

### 3. How can you tell if you are purchasing Genesis Parts?

Look for the Genesis Parts Logo on the package.

Genesis Parts exported to the U.S. are packaged with labels written only in English.

Genesis Parts are only sold through an authorized retailer of Genesis Branded products.

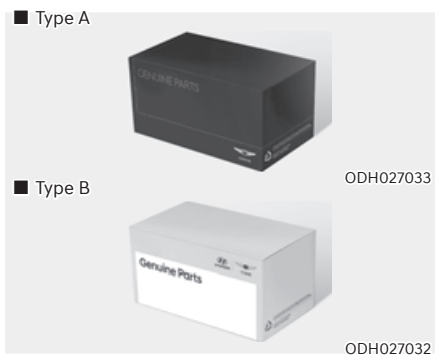

## HOW TO USE THIS MANUAL

We want to help you get the greatest possible driving pleasure from your vehicle. Your Owner's Manual can assist you in many ways. To gain an overview of the contents of your Owner's Manual, use the Table of Contents in the front of the manual. The first page of each Chapter includes a detailed Table of Contents of the topics in that Chapter.

To quickly locate information about your vehicle, use the Index in the back of the manual. It is an alphabetical list of what is in this manual and the page number where it can be found.

For your convenience, we have incorporated tabs on the right-hand page edges. These tabs are coded with the Chapter titles to assist you with navigating through the manual.

## SAFETY MESSAGES

Your safety, and the safety of others, is very important. This Owner's Manual provides you with many safety precautions and operating procedures. This information alerts you to potential hazards that may hurt you or others, as well as damage to your vehicle. Safety messages found on vehicle labels and in this manual describe these hazards and what to do to avoid or reduce the risks.

Warnings and instructions contained in this manual are for your safety. Failure to follow safety warnings and instructions can lead to serious injury or death.

Throughout this manual DANGER, WARNING, CAUTION, NOTICE and the SAFETY ALERT SYMBOL will be used.



This is the safety alert symbol. It is used to alert you to potential physical injury hazards. Obey all safety messages that follow this symbol to avoid possible injury or death. The safety alert symbol precedes the signal words DANGER, WARNING and CAUTION.



### **DANGER**

**DANGER** indicates a hazardous situation which, if not avoided, will result in death or serious injury.



### **CAUTION**

**CAUTION** indicates a hazardous situation which, if not avoided, could result in minor or moderate injury.



### **WARNING**

**WARNING** indicates a hazardous situation which, if not avoided, could result in death or serious injury.

### **NOTICE**

**NOTICE** indicates a situation which, if not avoided, could result in vehicle damage.

## FUEL REQUIREMENTS

Your new vehicle is designed to obtain maximum performance with UNLEADED FUEL, as well as minimize exhaust emissions and spark plug fouling.

For the optimal vehicle performance, we recommend you use unleaded gasoline which has an octane number  $((R+M)/2)$  of 91 (Research Octane Number 95) or higher.

### NOTICE

**Using unleaded gasoline that is lower than octane number  $((R+M)/2)$  of 91 (Research Octane Number 95) could result in loss of engine power and increase fuel consumption.**

### NOTICE

**To prevent damage to the engine and engine components, never add any fuel system cleaning agents to the fuel tank other than what has been specified.**

**Consult an authorized retailer of Genesis Branded products for additional information.**



### WARNING

- **Do not “top off” after the nozzle automatically shuts off when refueling.**
- **Always check that the fuel cap is installed securely to prevent fuel spillage in the event of an accident.**

### *Gasohol containing alcohol and methanol*

Gasohol, a mixture of gasoline and ethanol (also known as grain alcohol) are being marketed along with or instead of leaded or unleaded gasoline. For example, “E15” is a gasohol comprised of 15% ethanol and 85% gasoline. Do not use gasohol containing more than 15% ethanol, and do not use gasoline or gasohol containing any methanol. Either of these fuels may cause drivability problems and damage to the fuel system, engine control system and emission control system.

Discontinue using gasohol of any kind if drivability problems occur. “E85” fuel is an alternative fuel comprised of 85 percent ethanol and 15 percent gasoline, and is manufactured exclusively for use in Flexible Fuel Vehicles. “E85” is not compatible with your vehicle. Use of “E85” may result in poor engine performance and damage to your vehicle’s engine and fuel system. Genesis Branded Vehicle recommends that customers do not use fuel with an ethanol content exceeding 15 percent.

### NOTICE

**To prevent damage to your vehicle’s engine and fuel system:**

- **Never use gasohol which contains methanol.**
- **Never use gasohol containing more than 15% ethanol.**
- **Never use leaded fuel or leaded gasohol.**
- **Never use “E85” fuel.**

**Your New Vehicle Limited Warranty does not cover damage to the fuel system or any performance problems caused by the use of “E85” fuel.**

### ***Using Fuel Additives (except Detergent Fuel Additives)***

Using fuel additives such as:

- Silicone fuel additive
- Ferrocene (iron-based) fuel additive
- Other metallic-based fuel additives

may result in cylinder misfire, poor acceleration, engine stalling, damage to the catalyst, or abnormal corrosion, and may cause damage to the engine resulting in a reduction in the overall life of the powertrain.

- The Malfunction Indicator Lamp (MIL) may illuminate.

### **NOTICE**

**Damage to the fuel system or performance problem caused by the use of these fuels or fuel additives may not be covered by your New Vehicle Limited Warranty.**

### ***Gasoline containing MMT***

Some gasoline contains harmful manganese-based fuel additives such as MMT (Methylcyclopentadienyl Manganese Tricarbonyl).

Genesis Branded Vehicle does not recommend the use of gasoline containing MMT.

This type of fuel can reduce vehicle performance and affect your emission control system.

The malfunction indicator lamp on the cluster may come on.

### ***Detergent Fuel Additives***

Genesis Branded Vehicle recommends that you use good quality gasolines treated with detergent additives such as TOP TIER Detergent Gasoline, which help prevent deposit formation in the engine. These gasolines will help the engine run cleaner and enhance performance of the Emission Control System. For more information on TOP TIER Detergent Gasoline, please go to the website ([www.toptiergas.com](http://www.toptiergas.com)).

For customers who do not use TOP Tier Detergent Gasoline regularly, and have problems starting or the engine does not run smoothly, detergent-based fuel additives that you can purchase separately may be added to the gasoline. If TOP TIER Detergent Gasoline is not available, one bottle of additive added to the fuel tank at every 8,000 miles or 12 months is recommended.

Additives are available from your authorized retailer of Genesis Branded products along with information on how to use them. Do not mix other additives.

### ***Operation in foreign countries***

If you are going to drive your vehicle in another country, be sure to:

- Observe all regulations regarding registration and insurance.
- Determine that acceptable fuel is available.

## VEHICLE MODIFICATIONS

- This vehicle should not be modified. Modification of your vehicle could affect its performance, safety or durability and may even violate governmental safety and emissions regulations.
- In addition, damage or performance problems resulting from any modification may not be covered under warranty.
- If you use unauthorized electronic devices, it may cause the vehicle to operate abnormally, wire damage, battery discharge and fire. For your safety, do not use unauthorized electronic devices.

### NOTICE

**All warning sounds (e.g. welcome/good-bye sound, virtual engine sound) are generated from the speakers or interior amplifiers. If necessary, we recommend you to purchase Genesis Part to replace a speaker or interior amplifier. Any unauthorized product may cause a malfunction of the interior amplifiers.**

## VEHICLE BREAK-IN PROCESS

- Do not race the engine.
- While driving, keep your engine speed (RPM, or revolutions per minute) between 2,000 RPM and 4,000 RPM.
- Do not maintain a single speed for long periods of time, either fast or slow. Varying engine speed is needed to properly break-in the engine.
- Avoid hard stops, except in emergencies, to allow the brakes to seat properly.
- Do not use Launch Control (if equipped) during the break-in process.
- Fuel economy and engine performance may vary depending on vehicle break-in process and be stabilized after 4,000 miles (6,000 km). New engines may consume more oil during the vehicle break-in period.

### NOTICE

#### CALIFORNIA PROPOSITION 65 WARNING

**Items contained in motor vehicles or emitted from them are known to the State of California to cause cancer and birth defects or reproductive harm. These include:**

- Gasoline and its vapors
- Engine exhaust
- Used engine oil
- Interior passenger compartment components and materials
- Component parts which are subject to heat and wear

**In addition, battery posts, terminals and related accessories contain lead, lead compounds and other chemicals known to the State of California to cause cancer and reproductive harm.**

## VEHICLE DATA COLLECTION AND EVENT DATA RECORDERS

This vehicle is equipped with an event data recorder (EDR). The main purpose of an EDR is to record, in certain crash or near crash-like situations, such as an air bag deployment or hitting a road obstacle, data that will assist in understanding how a vehicle's systems performed. The EDR is designed to record data related to vehicle dynamics and safety systems for a short period of time, typically 30 seconds or less. The EDR in this vehicle is designed to record such data as:

- How various systems in your vehicle were operating;
- Whether or not the driver and passenger safety belts were buckled/fastened;
- How far (if at all) the driver was depressing the accelerator and/or brake pedal; and,
- How fast the vehicle was traveling.

These data can help provide a better understanding of the circumstances in which crashes and injuries occur. NOTE: EDR data are recorded by your vehicle only if a non-trivial crash situation occurs; no data are recorded by the EDR under normal driving conditions and no personal data (e.g., name, gender, age, and crash location) are recorded. However, other parties, such as law enforcement, could combine the EDR data with the type of personally identifying data routinely acquired during a crash investigation.

To read data recorded by an EDR, special equipment is required, and access to the vehicle or the EDR is needed. In addition to the vehicle manufacturer, other parties, such as law enforcement, that have the special equipment, can read the information if they have access to the vehicle or the EDR.

# 2. Vehicle Information, Consumer Information and Reporting Safety Defects

Exterior Overview (I) .....	2-2
Exterior Overview (II) .....	2-3
Interior Overview .....	2-4
Instrument Panel Overview (I) .....	2-5
Instrument panel Overview (II) .....	2-6
Engine Compartment .....	2-7
Dimensions.....	2-8
Engine .....	2-8
Bulb Wattage.....	2-9
Tires and Wheels.....	2-10
Air Conditioning System.....	2-11
Volume And Weight .....	2-11
Recommended Lubricants and Capacities.....	2-12
Recommended SAE Viscosity Number .....	2-14
Vehicle Identification Number (VIN) .....	2-15
Vehicle Certification Label .....	2-15
Tire Specification and Pressure Label .....	2-15
Engine Number .....	2-16
Air Conditioner Compressor Label .....	2-16
Consumer Information .....	2-17
Reporting Safety Defects .....	2-17



## EXTERIOR OVERVIEW (I)

■ Front view

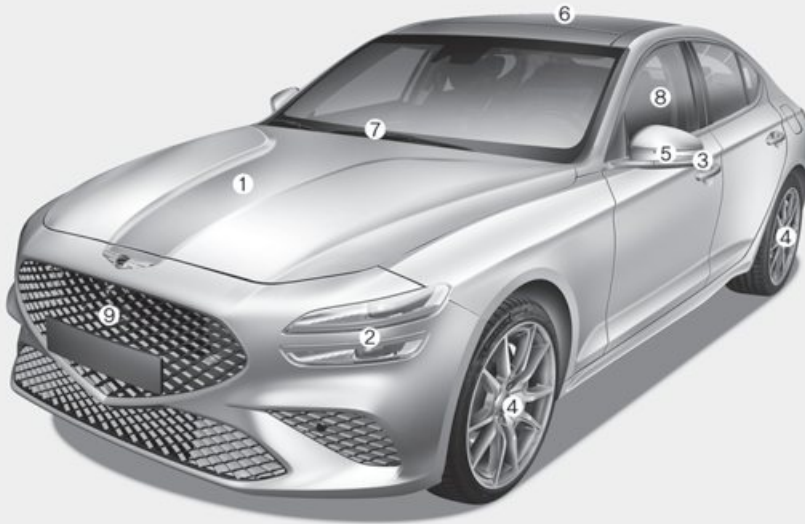

**The actual shape may differ from the illustration.**

OIK010001

1. Hood.....	5-63	6. Sunroof .....	5-58
2. Headlamp .....	9-62	7. Front windshield wiper blades .....	9-27
3. Side repeater lamp .....	9-62	8. Windows .....	5-53
4. Tires and wheels .....	9-32	9. Front radar .....	7-2
5. Side view mirror .....	5-49		

## EXTERIOR OVERVIEW (II)

### ■ Rear view

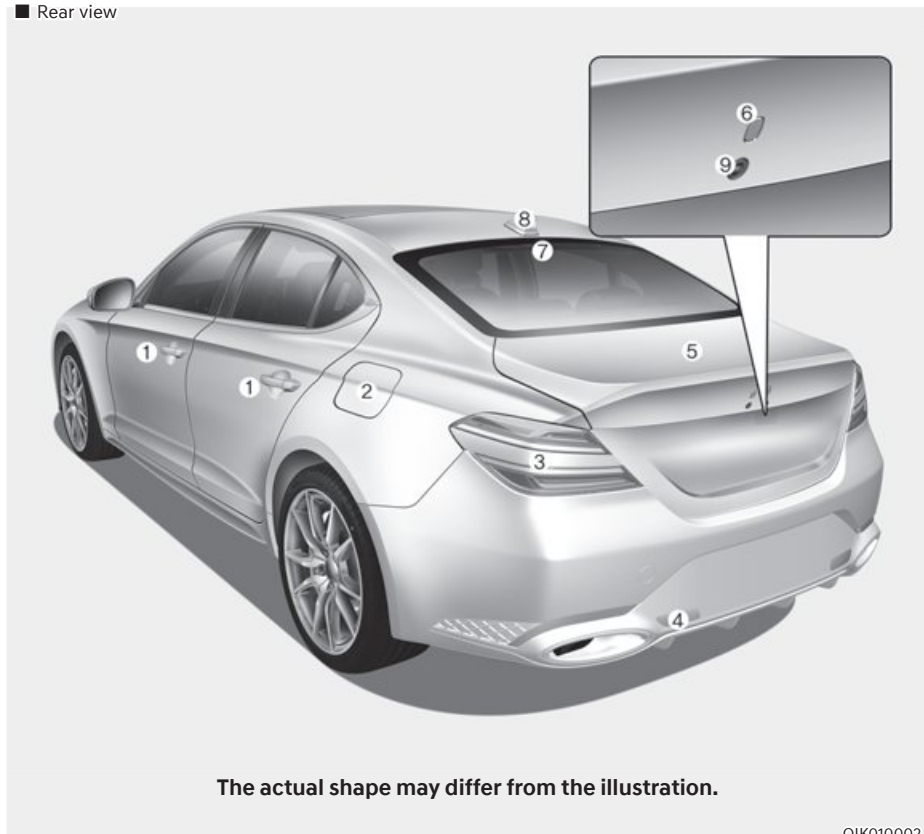

OIK010002

- |                                |            |                                 |            |
|--------------------------------|------------|---------------------------------|------------|
| 1. Door .....                  | 5-26       | 6. Trunk open button .....      | 5-64, 5-66 |
| 2. Fuel filler door .....      | 5-68       | 7. High mounted stop lamp ..... | 9-64       |
| 3. Rear combination lamp ..... | 9-63       | 8. Antenna .....                | 5-117      |
| 4. Reverse lamp .....          | 9-63       | 9. Rear view camera .....       | 7-87       |
| 5. Trunk .....                 | 5-64, 5-66 |                                 |            |

## INTERIOR OVERVIEW

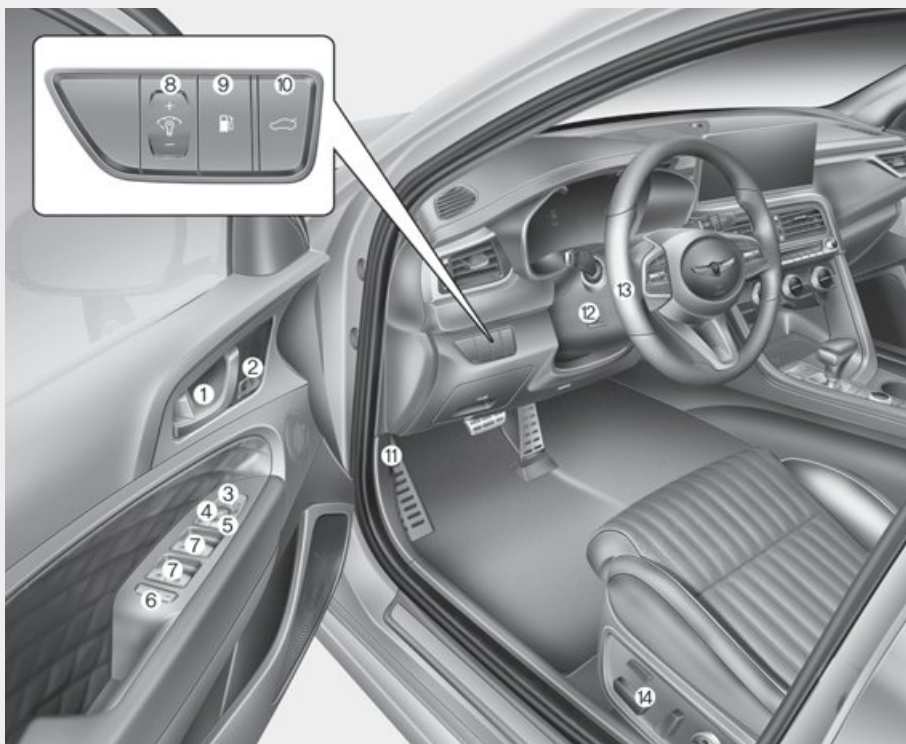

The actual shape may differ from the illustration.

OIK010003

- |  |      |   |      |
|--|------|---|------|
| 1. Inside door handle .....                              | 5-27 | 9. Fuel filler door open button.....        | 5-68 |
| 2. Integrated memory system .....                        | 5-32 | 10. Trunk open/close button .....           | 5-64 |
| 3. Side view mirror folding button .....                 | 5-50 | 11. Hood release lever.....                 | 5-63 |
| 4. Side view mirror control switch .....                 | 5-50 | 12. Steering wheel tilt/telescopic switch.. | 5-36 |
| 5. Central door lock switch .....                        | 5-28 | 13. Steering wheel.....                     | 5-35 |
| 6. Power window lock button .....                        | 5-56 | 14. Seat.....                               | 3-3  |
| 7. Power window switches .....                           | 5-53 |   |      |
| 8. Instrument panel illumination control<br>switch ..... | 4-5  |   |      |

## INSTRUMENT PANEL OVERVIEW (I)

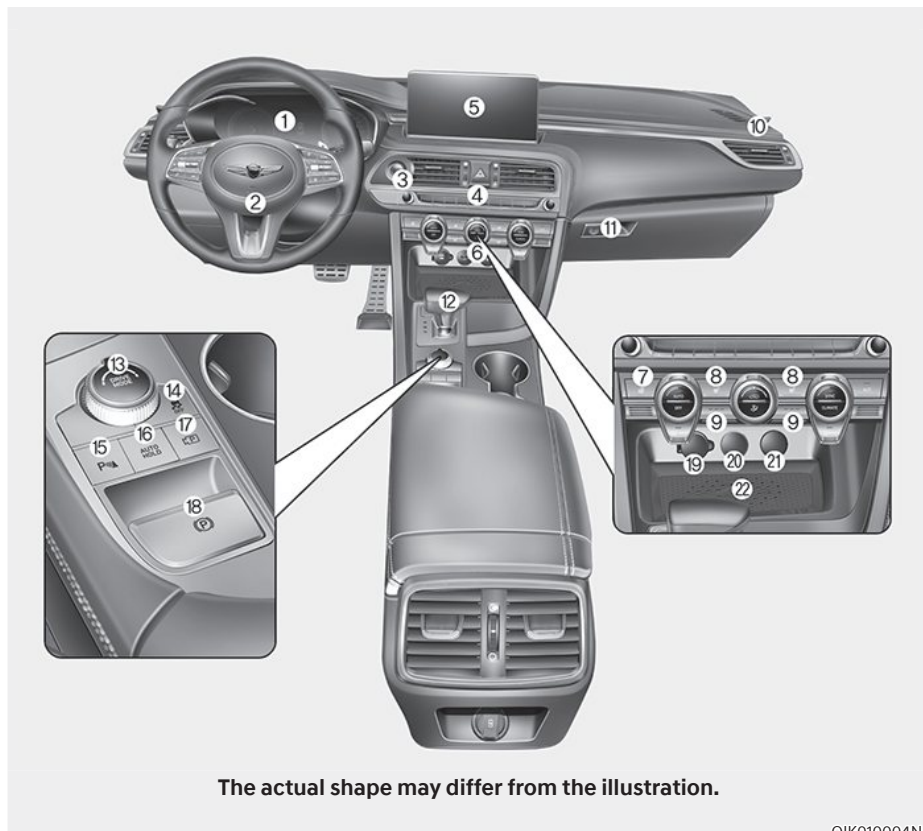

OIK010004N

- |   |       |  |       |
|---|-------|--|-------|
| 1. Instrument cluster .....               | 4-4   | 13. Drive mode integrated control .....                    | 6-45  |
| 2. Driver's front air bag .....           | 3-45  | 14. ESC (Electronic Stability Control) OFF<br>button ..... | 6-31  |
| 3. Engine Start/Stop button .....         | 6-5   | 15. Parking Safety button .....                            | 7-109 |
| 4. Hazard warning flasher button .....    | 8-2   | 16. Auto Hold button .....                                 | 6-26  |
| 5. Infotainment system .....              | 5-117 | 17. Parking/View button .....                              | 7-90  |
| 6. Automatic climate control system ..... | 5-88  | 18. EPB (Electronic Parking Brake)<br>switch .....         | 6-22  |
| 7. Heated steering wheel button .....     | 5-38  | 19. Power outlet .....                                     | 5-110 |
| 8. Seat warmer button .....               | 3-17  | 20. USB port .....   | 5-117 |
| 9. Air ventilation seat button .....      | 3-18  | 21. Wireless charging system indicator ....                | 5-112 |
| 10. Passenger's front air bag .....       | 3-45  | 22. Wireless charging system pad .....                     | 5-112 |
| 11. Glove box .....                       | 5-108 |  |       |
| 12. Transmission shift lever .....        | 6-9   |  |       |

## INSTRUMENT PANEL OVERVIEW (II)

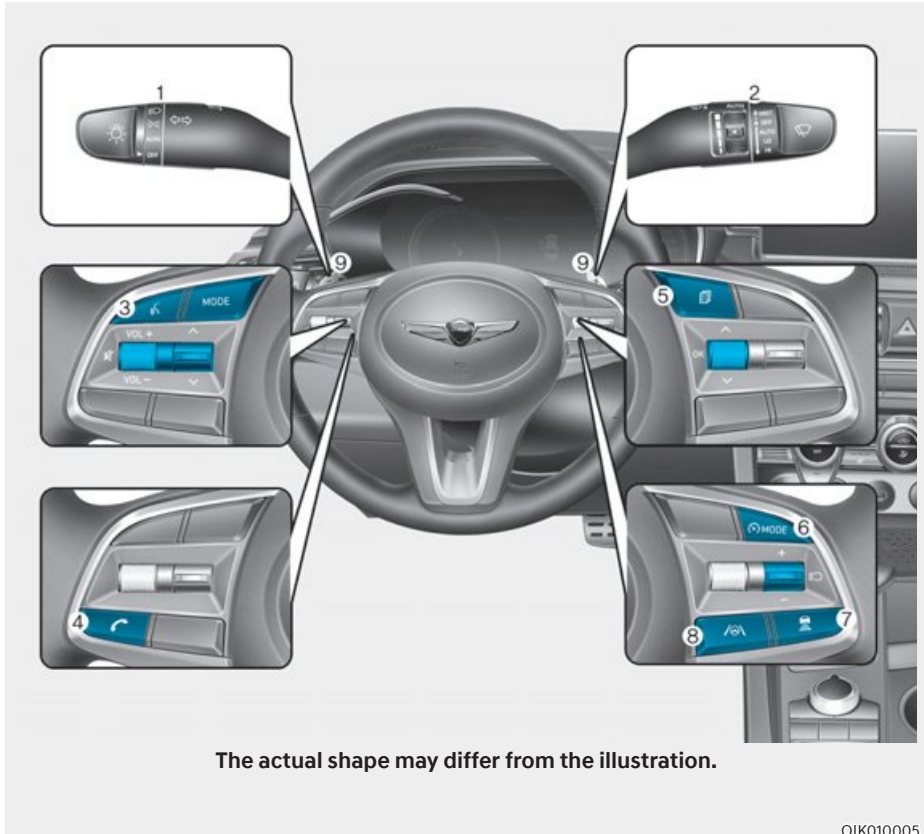

- |   |       |                                    |            |
|---|-------|------------------------------------|------------|
| 1. Lighting control lever .....               | 5-74  | 6. Driving Assist button.....      | 7-52       |
| 2. Wiper and washer control lever.....        | 5-85  | 7. Vehicle Distance button.....    | 7-52       |
| 3. Voice recognition button .....             | 5-118 | 8. Lane Driving Assist button..... | 7-17, 7-76 |
| 4. Bluetooth® hands-free phone<br>button..... | 5-119 | 9. Paddle shifter.....             | 6-14       |
| 5. LCD display control .....                  | 4-26  |                                    |            |

## ENGINE COMPARTMENT

### ■ 2.0L T-GDI

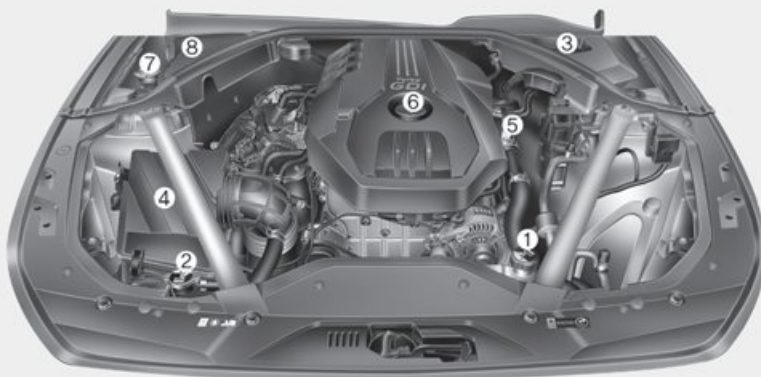

### ■ 3.3L T-GDI

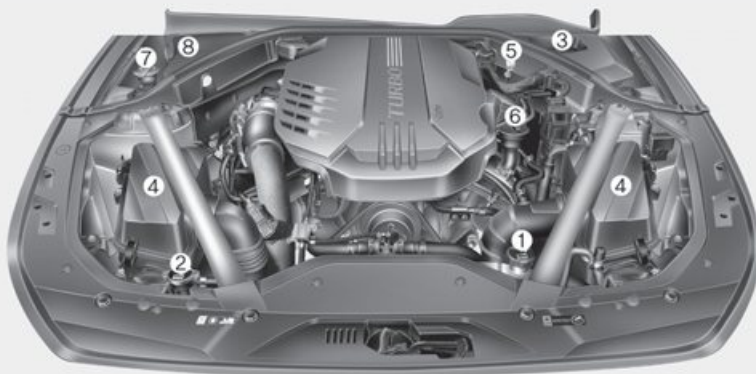

The actual engine compartment in the vehicle may differ from the illustration.

OIK077001/ OIK017007

- |                                  |      |   |      |
|----------------------------------|------|---|------|
| 1. Engine coolant reservoir..... | 9-20 | 5. Engine oil dipstick.....               | 9-17 |
| 2. Radiator cap.....             | 9-21 | 6. Engine oil filler cap.....             | 9-18 |
| 3. Brake fluid reservoir.....    | 9-23 | 7. Windshield washer fluid reservoir..... | 9-24 |
| 4. Air cleaner.....              | 9-25 | 8. Fuse box.....                          | 9-45 |

\* The battery is in the trunk.

## DIMENSIONS

Items		in (mm)
Overall length		184.45 (4,685)
Overall width		72.83 (1,850)
Overall height		55.12 (1,400)
Front tread	225/45R18	62.83 (1,596)
	225/40R19	62.83 (1,596)
	225/40ZR19	
Rear tread	225/45R18	64.25 (1,632)
	225/35R19	63.15 (1,604)
	255/35ZR19	
Wheelbase		111.61 (2,835)

## ENGINE

Items		2.0 T-GDI	3.3 T-GDI
Displacement	cu. in (cc)	121.9 (1,998)	203.94 (3,342)
Bore x Stroke	in. (mm)	3.39 x 3.39 (86 x 86)	3.78 x 3.299 (92 x 83.8)
Firing order		1-3-4-2	1-2-3-4-5-6
No. of cylinders		In-line 4 cylinder	V-type 6 cylinder

## BULB WATTAGE

Light bulb		Bulb type	Wattage
Front	Headlamp	Low	LED
		High	LED
	Turn signal lamp	LED	LED
	Parking lamp	LED	LED
	Side marker	LED	LED
	Daytime Running Lamp (DRL)	LED	LED
	Puddle lamp	LED	LED
Rear	Tail lamp	LED	LED
	Stop lamp / Turn signal lamp	LED	LED
	Reverse lamp	LED	LED
	Side marker	LED	LED
	License plate lamp	LED	LED
	High mounted stop lamp	LED	LED
Interior	Map lamp	LED	LED
	Room lamp	LED	LED
	Vanity mirror lamp	LED	LED
	Glove box lamp	LED	LED
	Foot lamp	LED	LED
	Trunk lamp	LED	LED



## TIRES AND WHEELS

Items		Tire size		Wheel size	Inflation pressure kPa (psi)		Wheel nut torque kgf•m (lbf•ft, N•m)	
					Normal load	Maximum Load OR over 100 mph *2		
Full size tire	2.0L T-GDI	18 inch	Front	225/45R18	8.0J X 18	250 (36)	260 (38)	11-13 (79-94, 107-127)
			Rear	225/45R18	8.0J X 18	270 (39)	270 (39)	
		19 inch	Front	225/40R19	8.0J X 19	250 (36)	260 (38)	
			Rear	225/35R19	8.5J X 19	250 (36)	270 (39)	
		19 inch	Front	225/40ZR19	8.0J X 19	250 (36)	260 (38)	
			Rear	255/35ZR19	8.5J X 19	250 (36)	270 (39)	
	3.3L T-GDI	18 inch	Front	225/45R18	8.0J X 18	250 (36)	260 (38)	
			Rear	225/45R18	8.0J X 18	270 (39)	270 (39)	
		19 inch (2WD)	Front	225/40R19	8.0J X 19	250 (36)	260 (38)	
			Rear	225/35R19	8.5J X 19	250 (36)	270 (39)	
		19 inch (2WD)	Front	225/40ZR19	8.0J X 19	250 (36)	260 (38)	
			Rear	255/35ZR19	8.5J X 19	250 (36)	270 (39)	
		19 inch (AWD)	Front	225/40R19	8.0J X 19	260 (38)	260 (38)	
			Rear	225/35R19	8.5J X 19	250 (36)	270 (39)	
19 inch (AWD)	Front	225/40ZR19	8.0J X 19	260 (38)	260 (38)			
	Rear	255/35ZR19	8.5J X 19	250 (36)	270 (39)			
Compact spare tire *1	T135/80R18		4.0T X 18	420 (60)	420 (60)			

\*1: If your vehicle is not equipped with a compact spare tire, your vehicle will be equipped with a Tire Mobility Kit.

\*2: Must drive only where the speed is legal.

### NOTICE

- **Ambient temperature affects tire pressure (about 1 psi (7 kPa) for every 12°F (7°C) change). If colder temperatures are anticipated, it is permissible to increase cold tire inflation pressure by up to 3 psi (20 kPa) over the specification. If extreme temperature changes are expected, be sure to check and adjust tire pressure accordingly.**
- **Tire inflation pressure decreases with higher elevation, and increases with lower elevation (about 2.4 psi (10 kPa) for every kilometer (or mile) elevation change). Be sure to check and adjust tire pressure accordingly when driving through changing elevations.**
- **Do not exceed the maximum inflation pressure, as found on the sidewall of the tire(s).**

**CAUTION**

- When replacing tires, use the same size originally supplied with the vehicle.
- Using tires of a different size can damage the related parts or not work properly.
- When replacing tires, **ALWAYS** use the same size, type, construction and tread pattern supplied with the vehicle for all tires.

**AIR CONDITIONING SYSTEM**

Item	Weight of volume	Classification
Refrigerant oz. (g)	19.2 ~ 21.0 (545 ~ 595)	R-1234yf
Compressor lubricant cu. in (cc)	3.1 ~ 3.9 (90 ~ 110)	PAG

Contact an authorized retailer of Genesis Branded products for more details.

**VOLUME AND WEIGHT**

Item	2.0L T-GDI		3.3L T-GDI	
	2WD	AWD	2WD	AWD
Gross vehicle weight lbs. (kg)	4,674 (2,120)	4,828 (2,190)	4,850 (2,200)	4,993 (2,265)
Luggage volume (SAE) cu ft (ℓ)	11.7 (330)			

## RECOMMENDED LUBRICANTS AND CAPACITIES

To help achieve proper engine and powertrain performance and durability, use only lubricants of the proper quality. The correct lubricants also help promote engine efficiency that results in improved fuel economy.

These lubricants and fluids are recommended for use in your vehicle.

Lubricant		Volume	Classification
Engine oil *1 *2 (drain and refill) 	2.0L T-GDI	5.9 US qt. (6.23 ℓ)	API SN PLUS/SP or ILSAC GF-6 *3 SAE : 0W-30
	3.3L T-GDI	7.29 US qt. (6.9 ℓ)	ACEA A5/B5*4 SAE : 5W-30
Automatic transmission fluid	2.0L T-GDI	9.72 US qt. (9.2 ℓ)	GS ATF SP-IV-RR Genesis/Hyundai genuine ATF SP-IV-RR or other brands meeting the above specification approved by Genesis Customer Care
	3.3L T-GDI		
Engine coolant	2.0L T-GDI	7.68 US qt. (7.27 ℓ)	Mixture of antifreeze and water (Phosphate-based Ethylene glycol coolant for aluminum radiator)
	3.3L T-GDI	9.84 US qt. (9.31 ℓ)	

\*1: Refer to the recommended SAE viscosity numbers on the next page.

\*2: If the above recommended specification oil is not available, SAE 0W-30 grade synthetic oil can be used. If mineral oil or semi-synthetic oil is used, it is a severe maintenance condition in terms of engine oil change.

\*3: Requires < API SN PLUS (or above) Full synthetic > grade engine oil. If a lower grade engine oil (mineral oil including Semi-synthetic) is used, then the engine oil and engine oil filter must be replaced as indicated severe maintenance condition.

\*4: Requires < API Latest (or ILSAC Latest) or ACEA A5/B5 Full synthetic > grade engine oil. If a lower grade engine oil (mineral oil including Semi-synthetic) is used. Then the engine oil and engine oil filter must be replaced as indicated severe maintenance condition.

Lubricant		Volume	Classification
Brake fluid		As required	FMVSS116 DOT-4
Rear differential oil * <sup>5</sup> (without LSD)	2.0L T-GDI	1.26 US qt. (1.2 ℓ)	HYPOID GEAR OIL API GL-5 SAE 75W/85 (SK HK SYN GEAR OIL 75W85 or equivalent)
	3.3L T-GDI	1.37 US qt. (1.3ℓ)	
Rear differential oil * <sup>5</sup> * <sup>6</sup> (with LSD)	2.0L T-GDI	1.37 US qt. (1.3 ℓ)	HYPOID GEAR OIL API GL-5 SAE 75W85 (SK HK JL SYN LSD GEAR OIL 75W85 PLUS OR SK HK SYN GEAR OIL 75W85 FM PLUS)
	3.3L T-GDI	1.47 US qt. (1.4 ℓ)	
Front differential oil * <sup>5</sup> (AWD)		0.74 US qt. (0.7ℓ)	HYPOID GEAR OIL API GL-5 SAE 75W/85 (SK HK SYN GEAR OIL 75W85 or equivalent)
Transfer case oil (AWD)	Gear/ Clutch	0.60 US qt. (0.57 ℓ)	SHELL TF 0870B
	Actuator	0.26 US qt. (0.25 ℓ)	
Fuel		15.8 US gal. (60 ℓ)	Refer to “Fuel requirements” in chapter 1.

\*<sup>5</sup>: If the front/rear differential is submerged, we recommend that you visit an authorized retailer of Genesis Branded products to immediately replace the differential oil.

\*<sup>6</sup>: Be sure to inject oil for exclusive use of LSD when replacing Rear Differential Oil (if equipped with Limited Slip Differential).

## Recommended SAE Viscosity Number

### CAUTION

**Always be sure to clean the area around any filler cap, drain plug, or dipstick before checking or draining any lubricant. This is especially important in dusty or sandy areas and when the vehicle is used on unpaved roads. Cleaning the plug and dipstick areas will prevent dirt and grit from entering the engine and other mechanisms that could be damaged.**

Engine oil viscosity (thickness) has an effect on fuel economy and cold weather operating (engine start and engine oil flowability). Lower viscosity engine oils can provide better fuel economy and cold weather performance, however, higher viscosity engine oils are required for satisfactory lubrication in hot weather. Using oils of any viscosity other than those recommended could result in engine damage.

When choosing an oil, consider the range of temperature your vehicle will be operated in before the next oil change. Proceed to select the recommended oil viscosity from the chart.

Temperature Range for SAE Viscosity Numbers										
Temperature	°C	-30	-20	-10	0	10	20	30	40	50
	(°F)	-10	0	20	40	60	80	100	120	
2.0L T-GDI *1	0W-30									
3.3L T-GDI *2					10W-30					
	5W-30									

\*1: Requires < API SN PLUS (or above) Full synthetic > grade engine oil. If a lower grade engine oil (mineral oil including Semi-synthetic) is used, then the engine oil and engine oil filter must be replaced as indicated severe maintenance condition.

\*2: For better fuel economy, it is recommended to use the engine oil of a viscosity grade SAE 5W-30. However, if the engine oil is not available in your country, select the proper engine oil using the engine oil viscosity chart.



An engine oil displaying this American Petroleum Institute (API) Certification Mark conforms to the International Lubricant Specification Advisory Committee (ILSAC). It is recommended to only use engine oils that uphold this API Certification Mark.

## VEHICLE IDENTIFICATION NUMBER (VIN)

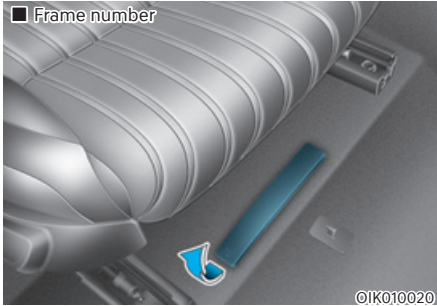

The vehicle identification number (VIN) is the number used in registering your vehicle and in all legal matters pertaining to its ownership, etc.

The number is punched on the floor under the right front seat. To check the number, open the cover.

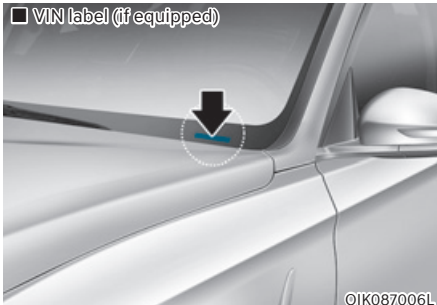

The VIN is also on a plate attached to the top of the left side dashboard. The number on the plate can easily be seen through the windshield from outside.

## VEHICLE CERTIFICATION LABEL



The vehicle certification label attached on the driver's (or front passenger's) side center pillar gives the vehicle identification number (VIN).

## TIRE SPECIFICATION AND PRESSURE LABEL

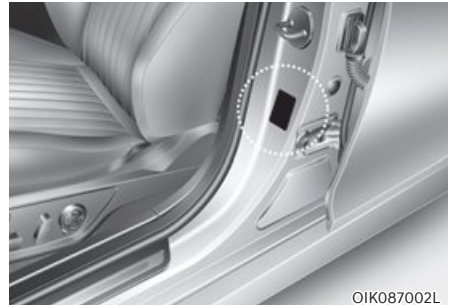

The tires supplied on your new vehicle are chosen to provide the best performance for normal driving.

The tire label located on the driver's side center pillar gives the tire pressures recommended for your vehicle.

## ENGINE NUMBER

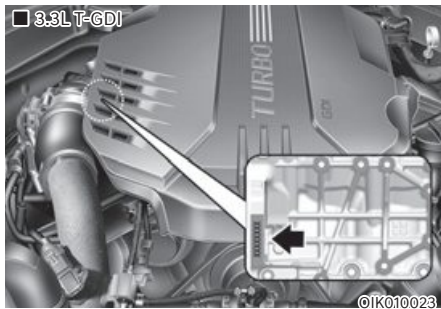
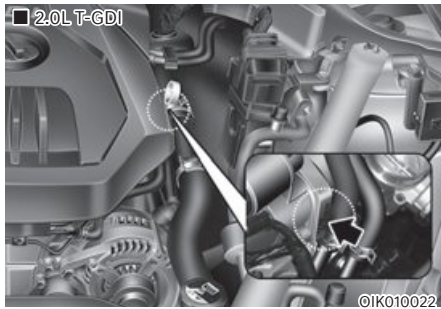

The engine number is stamped on the engine block as shown in the drawing.

## AIR CONDITIONER COMPRESSOR LABEL

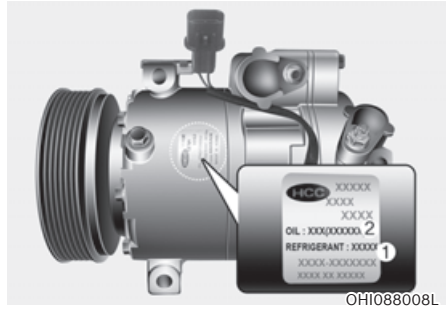

A compressor label informs you the type of compressor your vehicle is equipped with such as model, supplier part number, production number, refrigerant (1) and refrigerant oil (2).

## CONSUMER INFORMATION

This consumer information has been prepared in accordance with regulations issued by the National Highway Traffic Safety Administration of the U.S. Department of Transportation. Your retailer of Genesis Branded products will help answer any questions you may have as you read this information.

Genesis Branded Vehicles are designed and manufactured to meet or exceed all applicable safety standards.

For your safety, however, we strongly urge you to read and follow all directions in this Owner's Manual, particularly the information under the headings "NOTICE", "CAUTION" and "WARNING".

## REPORTING SAFETY DEFECTS

If you believe that your vehicle has a defect which could cause a crash or could cause injury or death, you should immediately inform the National Highway Traffic Safety Administration (NHTSA) in addition to notifying Genesis Customer Care.

If NHTSA receives similar complaints, it may open an investigation, and if it finds that a safety defect exists in a group of vehicles, it may order a recall and remedy campaign. However, NHTSA cannot become involved in individual problems between you, your dealer, or Genesis Customer Care.

To contact NHTSA, you may call the Vehicle Safety Hotline toll-free at 1-888-327-4236 (TTY: 1-800-424-9153);

go to <http://www.safercar.gov>;

download the SaferCar mobile application;

or write to: Administrator, NHTSA.

1200 New Jersey Ave, SE.,

Washington, DC. 20590.

You can also obtain other information about motor vehicle safety from <http://www.safercar.gov>.



# 3. Safety System

- Important Safety Precautions .....3-2
  - Always Wear Your Seat Belt ..... 3-2
  - Restrain All Children ..... 3-2
  - Air Bag Hazards ..... 3-2
  - Driver Distraction ..... 3-2
  - Control Your Speed ..... 3-2
  - Keep Your Vehicle in Safe Condition ..... 3-2
- Seats ..... 3-3
  - Safety Precautions ..... 3-5
  - Front Seats ..... 3-6
  - Rear Seats ..... 3-11
  - Head Restraints ..... 3-13
  - Seat Warmers ..... 3-17
  - Air Ventilation Seats ..... 3-19
  - Rear Occupant Alert (ROA) ..... 3-21
- Seat Belts ..... 3-22
  - Seat Belt Safety Precautions ..... 3-22
  - Seat Belt Warning Light ..... 3-23
  - Seat Belt Restraint System ..... 3-24
  - Additional Seat Belt Safety Precautions ..... 3-31
  - Care of Seat Belts ..... 3-33
- Child Restraint System (CRS) ..... 3-34
  - Children Always in the Rear ..... 3-34
  - Selecting a Child Restraint System (CRS) ..... 3-35
  - Installing a Child Restraint System (CRS) ..... 3-37
- Air Bag - Supplemental Restraint System ..... 3-43
  - Where are the Air Bags? ..... 3-45
  - How does the Air Bags System Operate? ..... 3-49
  - What to Expect After an Air Bag Inflates ..... 3-53
  - Occupant Classification System (OCS) ..... 3-54
  - Why Didn't My Air Bag Go Off in a Collision? ..... 3-59
  - SRS Care ..... 3-64
  - Additional Safety Precautions ..... 3-65
  - Air Bag Warning Labels ..... 3-65

## IMPORTANT SAFETY PRECAUTIONS

You will find many safety precautions and recommendations throughout this section, and throughout this manual. The safety precautions in this section are among the most important.

### Always Wear Your Seat Belt

A seat belt is your best protection in all types of accidents. Air bags are designed to supplement seat belts, not replace them. So even though your vehicle is equipped with air bags, ALWAYS make sure you and your passengers wear your seat belts, and wear them properly.

### Restrain All Children

All children under age 13 should ride in your vehicle properly restrained in a rear seat, not the front seat. Infants and small children should be restrained in an appropriate Child Restraint System. Larger children should use a booster seat with the lap/shoulder belt until they can use the seat belt properly without a booster seat.

### Air Bag Hazards

While air bags can save lives, they can also cause serious or fatal injuries to occupants who sit too close to them, or who are not properly restrained. Infants, young children, and short adults are at the greatest risk of being injured by an inflating air bag. Follow all instructions and warnings in this manual.

### Driver Distraction

Driver distraction presents a serious and potentially deadly danger, especially for inexperienced drivers. Safety should be the first concern when behind the wheel and drivers need to be aware of the wide array of potential distractions, such as drowsiness, reaching for objects, eating, personal grooming, other passengers, and using mobile phones.

Drivers can become distracted when they take their eyes and attention off the road or their hands off the wheel to focus on activities other than driving. To reduce your risk of distraction and an accident:

- ALWAYS set up your mobile devices (i.e., MP3 players, phones, navigation units, etc.) when your vehicle is parked or safely stopped.
- ONLY use your mobile device when allowed by laws and conditions permit safe use. NEVER text or email while driving. Most countries have laws prohibiting drivers from texting. Some countries and cities also prohibit drivers from using handheld phones.
- NEVER let the use of a mobile device distract you from driving. You have a responsibility to your passengers and others on the road to always drive safely, with your hands on the wheel as well as your eyes and attention on the road.

### Control Your Speed

Excessive speed is a major factor in crash injuries and deaths. Generally, the higher the speed, the greater the risk, but serious injuries can also occur at lower speeds. Never drive faster than is safe for current conditions, regardless of the maximum speed posted.

### Keep Your Vehicle in Safe Condition

Having a tire blowout or a mechanical failure can be extremely hazardous. To reduce the possibility of such problems, check your tire pressures and condition frequently, and perform all regularly scheduled maintenance.

## SEATS

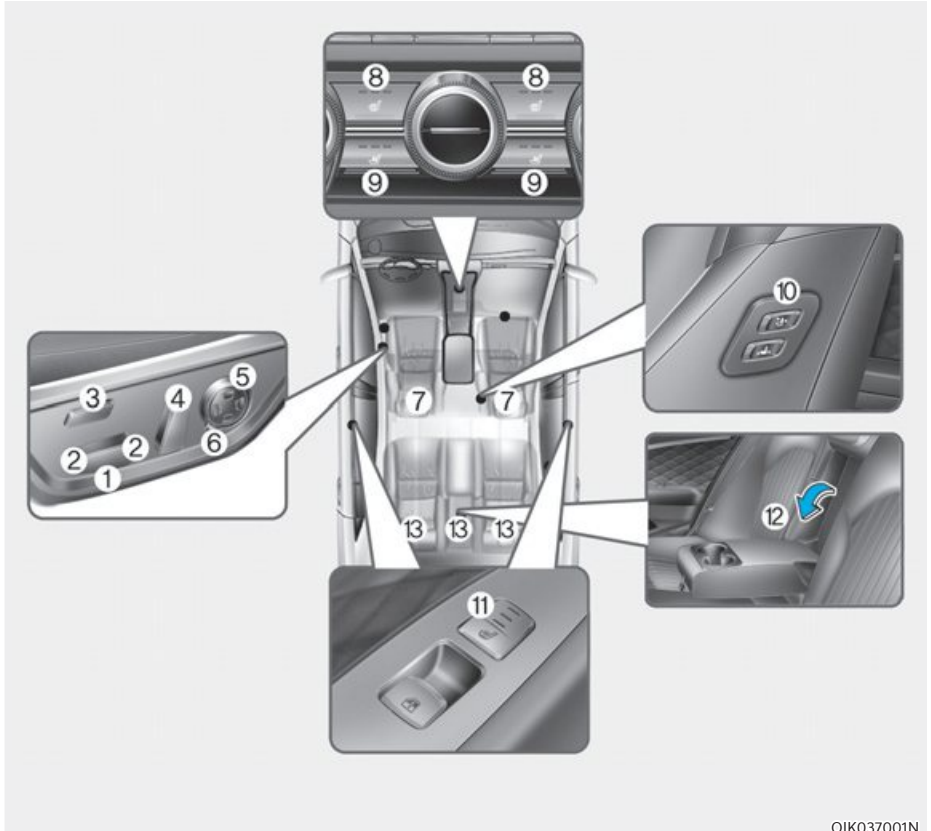

OIK037001N

**Front seat**

- (1) Seat sliding forward or rearward
- (2) Seat tilt/height adjustment
- (3) Seat cushion length adjustment\*
- (4) Seatback angle adjustment
- (5) Lumbar support adjustment\*
- (6) Seat bolster adjustment\*
- (7) Head restraint
- (8) Seat warmer\*
- (9) Air ventilation seat\*
- (10) Front passenger seat adjustment\*

**Rear seats**

- (11) Seat warmer\*
- (12) Armrest
- (13) Head restraint

\* : if equipped

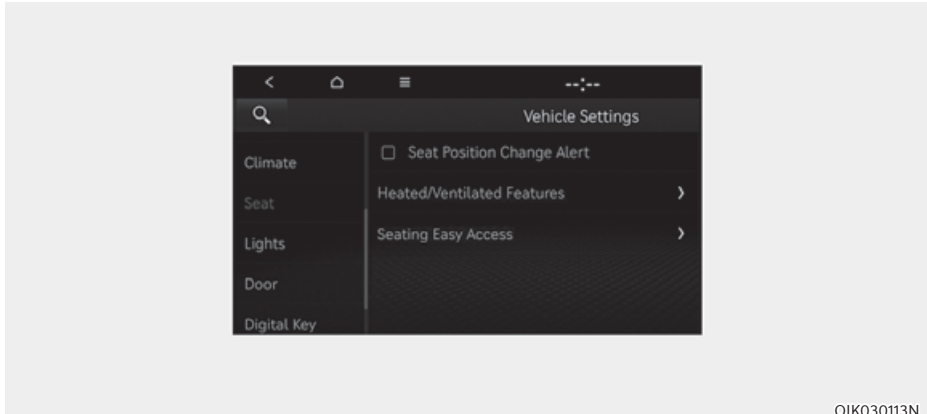

OIK030113N

### Infotainment system

Select 'Setup → Vehicle Settings → Seat' from the Settings menu in the infotainment system screen, you may use various convenience functions.

- Seat position change alert : Detailed information of the seat switch and image is displayed when the driver's seat position is moves.
- Heated/Ventilated features
  - Auto. Controls That Use Climate Control Settings (for driver's seat) : The seat temperature is automatically controlled.
- Seating easy access
  - Steering wheel easy access : Moves the steering wheel when the driver enters or leaves the vehicle.
  - Driver seat easy access : The distance (Normal/Extended/Off) the seat automatically moves when the driver enters or leaves the vehicle may be selected.

See additional information in supplied Infotainment Manual.

### Information

The information provided may differ depending on which functions are applicable to your vehicle.

## Safety Precautions

Adjusting the seats so that you are sitting in a safe and comfortable position plays an important role for the safety of the driver and passengers, along with seat belts and air bags when in an accident.



### WARNING

**Do not use a cushion that reduces friction between the seat and the passenger. The passenger's hips may slide under the lap portion of the seat belt during an accident or a sudden stop.**

**Serious or fatal internal injuries could result because the seat belt cannot operate properly.**

### *Air bags*

You can take steps to reduce the risk of being injured by an inflating air bag. Sitting too close to an air bag greatly increases the risk of injury in the event the air bag inflates.

The National Highway Traffic Safety Administration (NHTSA) recommends that drivers allow at least 10 inches (25 cm) between the center of the steering wheel and their chest.



### WARNING

**To reduce the risk of serious injury or death from an inflating air bag, take the following precautions:**

- **Adjust the driver's seat as far to the rear as possible maintaining the ability to control the vehicle.**
- **Adjust the front passenger seat as far to the rear as possible.**
- **Hold the steering wheel by the rim with hands at the 9 o'clock and 3 o'clock positions to minimize the risk of injuries to your hands and arms.**
- **NEVER place anything or anyone between you and the air bag.**
- **Do not allow the front passenger to place feet or legs on the dashboard to minimize the risk of leg injuries.**

### *Seat belts*

Always fasten your seat belt before starting any trip. At all times, passengers should sit upright and be properly restrained. Infants and small children must be restrained in appropriate Child Restraint Systems. Children who have outgrown a booster seat and adults must be restrained using the seat belts.



### WARNING

**Take the following precautions when adjusting your seat belt:**

- **NEVER use one seat belt for more than one occupant.**
- **Always position the seatback upright with the lap portion of the seat belt snug and low across the hips.**
- **NEVER allow children or small infants to ride on a passenger's lap.**
- **Do not route the seat belt across your neck, across sharp edges, or reroute the shoulder strap away from your body.**
- **Do not allow the seat belt to become caught or jammed.**

## Front Seats

The front seat can be adjusted by using the control switches located on the outside of the seat cushion. Before driving, adjust the seat to the proper position so that you can easily control the steering wheel, foot pedals and controls on the instrument panel.



### WARNING

Take the following precautions when adjusting your seat:

- **NEVER attempt to adjust the seat while the vehicle is moving.** The seat could respond with unexpected movement and may cause loss of vehicle control resulting in an accident.
- Do not place anything under the front seats. Loose objects in the driver's foot area could interfere with the operation of the foot pedals, causing an accident.
- Do not allow anything to interfere with the normal position and proper locking of the seatback.
- Do not place a cigarette lighter on the floor or seat. When you operate the seat, gas may exit out of the lighter causing a fire.
- Use extreme caution when picking up small objects trapped under the seats or between the seat and the center console. Your hands might be cut or injured by the sharp edges of the seat mechanism.
- If there are occupants in the rear seats, be careful while adjusting the front seat position.
- Make sure that the seat is locked in place after the adjustment. If not, the seat might move unexpectedly resulting in an accident.



### CAUTION

To prevent injury:

- **Do not adjust your seat while wearing your seat belt.** Moving the seat cushion forward may cause strong pressure on your abdomen.
- **Do not allow your hands or fingers to get caught in the seat mechanisms while the seat is moving.**



### WARNING

**NEVER** allow children in the vehicle unattended. The power seats are operable when the vehicle is turned off.

### NOTICE

To prevent damage to the seats:

- Always stop adjusting the seats when the seat has been adjusted as far forward or rearward as possible.
- Do not adjust the seats longer than necessary when the vehicle is turned off. This may result in unnecessary battery drain.
- Do not operate two or more seats at the same time. This may result in an electrical malfunction.

### Forward and rearward adjustment

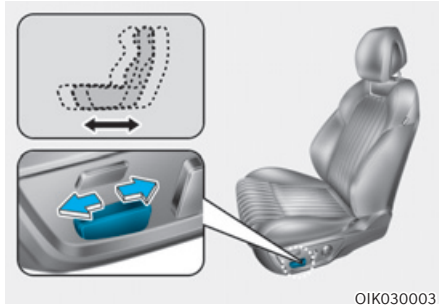

To move the seat forward or rearward:

1. Push the control switch forward or rearward.
2. Release the switch once the seat reaches the desired position.

### Seat cushion tilt/height adjustment

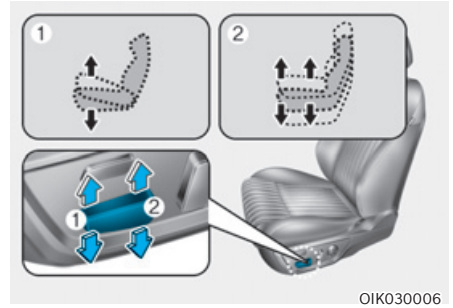

#### Seat cushion tilt (1)

To change the angle of the front part of the seat cushion:

Push the front portion of the control switch up to raise or down to lower the front part of the seat cushion.

Release the switch once the seat reaches the desired position.

#### Seat cushion height (2)

To change the height of the seat cushion:

Push the rear portion of the control switch up to raise or down to lower the height of the seat cushion.

Release the switch once the seat reaches the desired position.

### Seatback angle adjustment

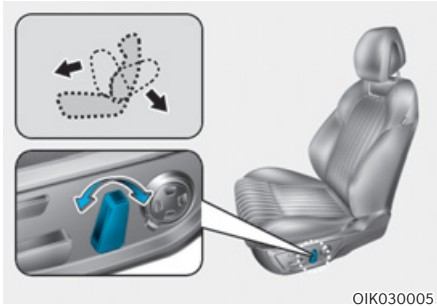

To recline the seatback:

1. Push the control switch forward or rearward.
2. Release the switch once the seatback reaches the desired position.

### Reclining seatback

Sitting in a reclined position when the vehicle is in motion can be dangerous. Even when buckled up, the protections of your restraint system (seat belts and air bags) is greatly reduced by reclining your seatback.



### WARNING

**NEVER** ride with a reclined seatback when the vehicle is moving.

**Riding with a reclined seatback increases your chance of serious or fatal injuries in the event of a collision or sudden stop.**

**Driver and passengers should ALWAYS sit well back in their seats, properly belted, and with the seatbacks upright.**

Seat belts must be snug against your hips and chest to work properly. When the seatback is reclined, the shoulder belt cannot do its job because it will not be snug against your chest. Instead, it will be in front of you. During an accident, you could be twined around the seat belt, causing neck or other injuries.

The more the seatback is reclined, the greater chance the passenger's hips will slide under the lap belt or the passenger's neck will strike the shoulder belt.

### Seat cushion extension adjustment (for driver's seat) (if equipped)

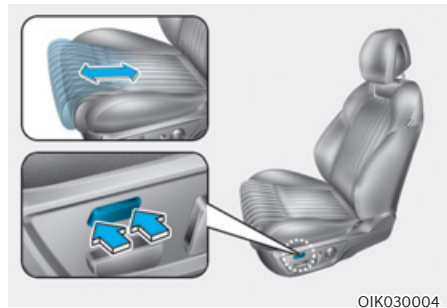

To move the front part of the cushion forward or rearward:

1. Push the control switch forward or rearward.
2. Release the switch once the seat cushion reaches the desired length.



### **Lumbar support (if equipped)**

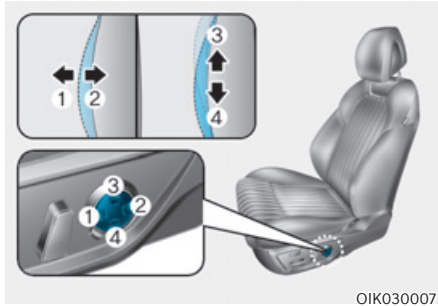

OIK030007

To adjust the lumbar support:

1. Press the front portion of the switch (1) to increase support or the rear portion of the switch (2) to decrease support.
2. Press switch (3) or (4) to move the support position up or down.
3. Release the switch once the lumbar support reaches the desired position.

### **Seat bolster adjustment (for driver's seat) (if equipped)**

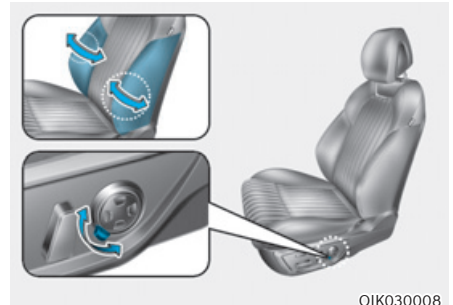

OIK030008

To adjust seat bolster:

1. Push the adjustment lever clockwise, the seatback bolster will be adjusted inward. Push the switch counterclockwise, the seatback bolster will be adjusted outward.
2. Release the lever once the bolster reaches the desired position.

### Walk-in switch (if equipped)



The rear seat passenger may use the switches to control the front passenger seat.

- Sliding forward or rearward:  
Press the switch (1) or (2) to move the front passenger seat forward or rearward.
- Seatback angle:  
Press the switch (3) or (4) to recline the front passenger seatback forward or rearward.

### **WARNING**

**Do not adjust the passenger seat when a passenger is seated.**

### Seatback pocket

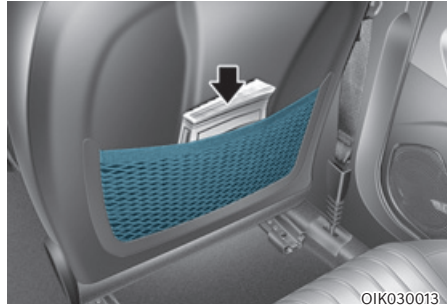

The seatback pocket is provided on the back of the front seatbacks.

### **CAUTION**

**Do not put heavy or sharp objects in the seatback pockets. In an accident they could come loose from the pocket and injure occupants.**

## Rear Seats

### ***Folding the rear seat***

The rear seatbacks can be folded down to facilitate carrying long items or to increase the luggage capacity of the vehicle.



### **WARNING**

- **Never allow passengers to sit on top of the folded down seatback while the vehicle is moving. This is not a proper seating position and no seat belts are available for use. This could result in serious injury or death in case of an accident or sudden stop.**
- **Objects carried on the folded down seatback should not extend higher than the top of the front seatbacks. This could allow cargo to slide forward and cause injury or damage during sudden stops.**

To fold down the rear seatback:

1. Set the front seatback to the upright position and if necessary, slide the front seat forward.

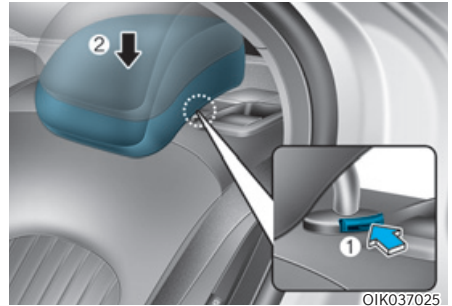

2. Lower the rear head restraints to the lowest position by pushing and holding the release button (1) and pushing down on the headrest (2).

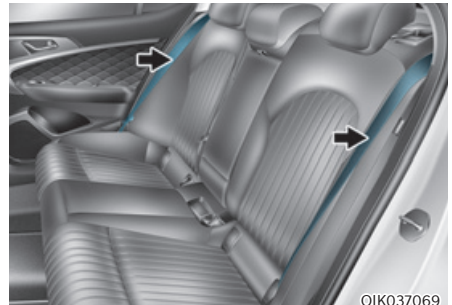

3. Move the seatbelt toward the outboard position before folding down the seatback to avoid the seatbelt system interfering with the seatback.

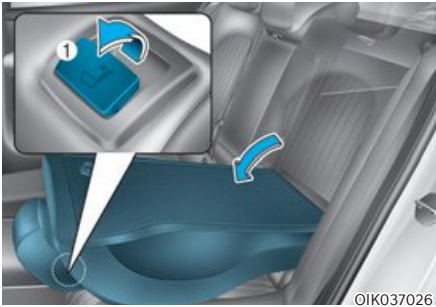

4. Pull up the seatback folding lever (1), then fold the seat toward the front of the vehicle.

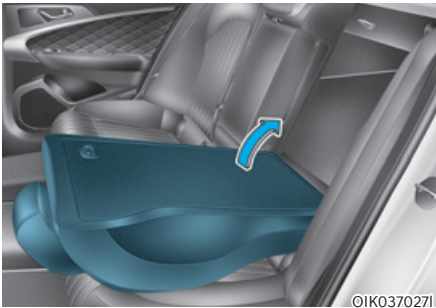

5. To use the rear seat, lift and unfold the seatback to the upright position. Push the seatback firmly until it clicks into place. Make sure the seatback is locked in place.

 **WARNING**

When returning the rear seatback from a folded to an upright position, hold the seatback and return it slowly. Ensure that the seatback is completely locked into its upright position by pushing on the top of the seatback. In an accident or sudden stop, the unlocked seatback could allow cargo to move forward with great force and enter the passenger compartment, which could result in serious injury or death.

 **WARNING**

Do not place objects in the rear seats, since they cannot be properly secured and may hit vehicle occupants in a collision causing serious injury or death.

 **WARNING**

Make sure the vehicle is off, the vehicle is shifted to P (Park), and the parking brake is securely applied whenever loading or unloading cargo. Failure to take these steps may allow the vehicle to move if the shift lever is inadvertently moved to another position.

 **CAUTION**

- Be careful when loading cargo through the rear passenger seats to prevent damage to the vehicle interior.
- When cargo is loaded through the rear passenger seats, ensure the cargo is properly secured to prevent it from moving while driving.
- Unsecured cargo in the passenger compartment can cause damage to the vehicle or injury to it's occupants.

## Armrest

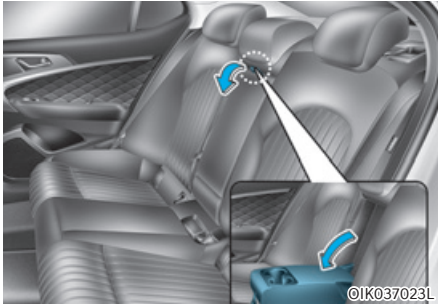

The armrest is located in the center of the rear seat. Use the strap in the center of the armrest to pull it down.

## Head Restraints

The vehicle's front and rear seats have adjustable head restraints. The head restraints provide comfort for passengers, but more importantly they are designed to help protect passengers from whiplash and other neck and spinal injuries during an accident, especially in a rear impact collision.



### WARNING

To reduce the risk of serious injury or death in an accident, take the following precautions when adjusting your head restraints:

- Always properly adjust the head restraints for all passengers **BEFORE** starting the vehicle.
- **NEVER** let anyone ride in a seat with the head restraint removed or reversed.

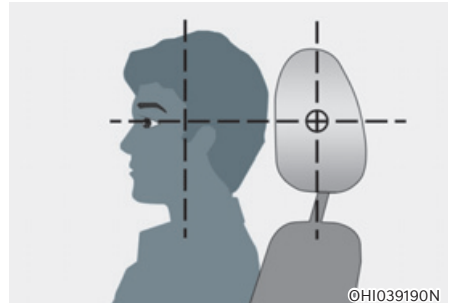

- Adjust the head restraints so the middle of the head restraint is at the same height as the height of the top of the eyes.
- **NEVER** adjust the head restraint position of the driver's seat when the vehicle is in motion.
- Adjust the head restraint as close to the passenger's head as possible. Do not use a seat cushion that holds the body away from the seatback.
- Make sure the head restraint locks into position after adjusting it.

**WARNING**

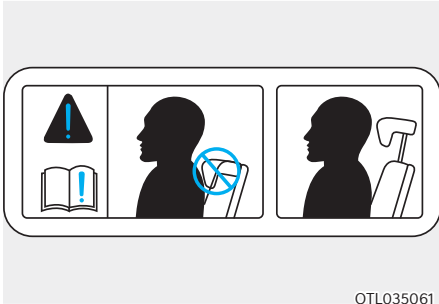

**When sitting on the rear seat, do not adjust the height of the head restraint to the lowest position.**

**CAUTION**

**When there is no occupant in the rear seats, adjust the height of the head restraint to the lowest position. The rear seat head restraint can reduce the visibility of the rear area.**

**NOTICE**

**To prevent damage, NEVER hit or pull on the head restraints.**

**Front seat head restraints**

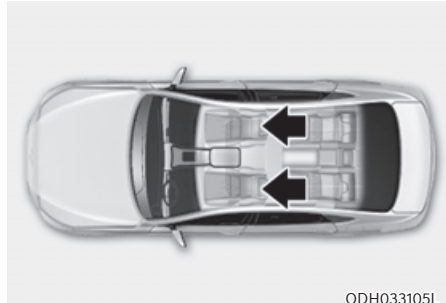

The driver's and front passenger's seats are equipped with adjustable head restraints for the passenger's safety and comfort.

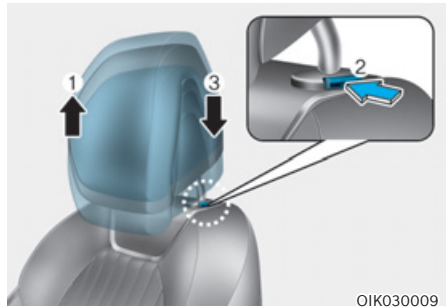

**Adjusting the height up and down**

To raise the head restraint:

1. Pull it up to the desired position (1).

To lower the head restraint:

1. Push and hold the release button (2) on the head restraint support.
2. Lower the head restraint to the desired position (3).

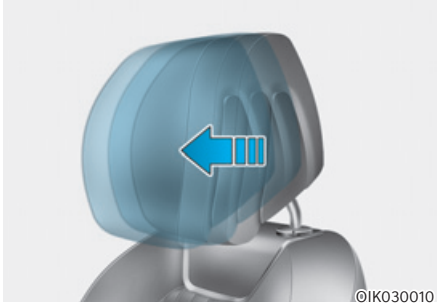

### Forward and rearward adjustment

The head restraint can be adjusted forward to 3 different positions by pulling the headrest detent forward to the desired position. To adjust the head restraint to its furthest rearwards position, pull it fully forward to the farthest position and release it.

### NOTICE

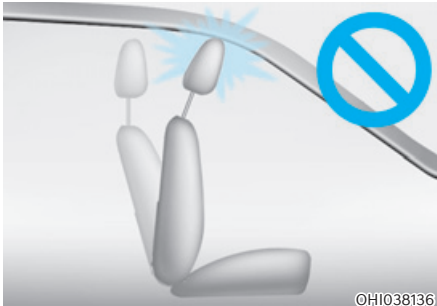

If you recline the seatback towards the front with the head restraint and seat cushion raised, the head restraint may come in contact with the sunvisor or other parts of the vehicle.

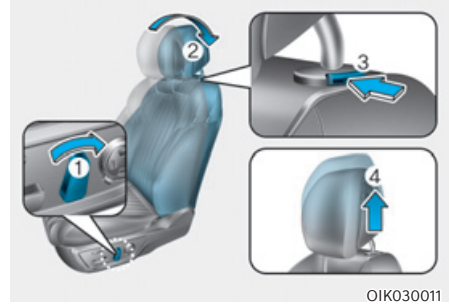

### Removal/Reinstall

To remove the head restraint:

1. Recline the seatback (2) with the seatback angle switch (1).
2. Raise the head restraint as far as it can go.
3. Press the head restraint release button (3) while pulling the head restraint up (4).



### WARNING

**NEVER** allow anyone to travel in a seat with the head restraint removed.

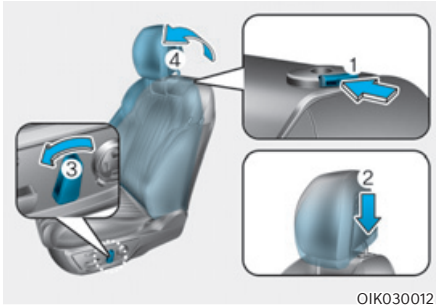

To reinstall the head restraint :

1. Recline the seatback.
2. Put the head restraint poles (2) into the holes while pressing the release button (1).
3. Adjust the head restraint to the appropriate height.
4. Recline the seatback (4) with the seatback angle switch (3).



### WARNING

Always make sure the head restraint locks into position after reinstalling and adjusting it properly.

### Rear seat head restraints

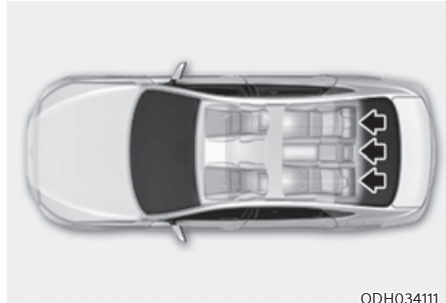

The rear seats are equipped with head restraints in all the seating positions for the passenger's safety and comfort.

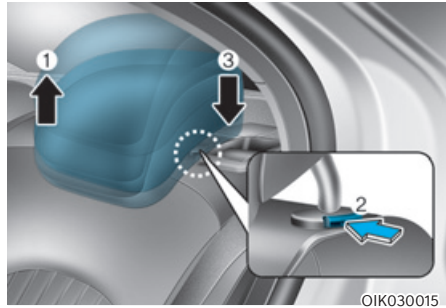

### Adjusting the height up and down

To raise the head restraint:

1. Pull it up to the desired position (1).

To lower the head restraint:

1. Push and hold the release button (2) on the head restraint support.
2. Lower the head restraint to the desired position (3).



## Seat Warmers (if equipped)

Seat warmers are provided to warm the seats during cold weather.

During mild weather or under conditions where the operation of the seat warmer is not needed, keep the seat warmers OFF.



### WARNING

The seat warmers can cause a **SERIOUS BURN**, even at low temperatures and especially if used for long periods of time.

Passengers must be able to feel if the seat is becoming too warm so they can turn it off, if needed.

People who cannot detect temperature change or pain to the skin should use extreme caution, especially the following types of passengers:

- Infants, children, elderly or disabled persons, or hospital outpatients.
- People with sensitive skin or who burn easily.
- Fatigued individuals.
- Intoxicated individuals.
- People taking medication that can cause drowsiness or sleepiness.



### WARNING

**NEVER** place anything on the seat that insulates against heat when the seat warmer is in operation, such as a blanket or seat cushion. This may cause the seat warmer to overheat, causing a burn or damage to the seat.

### NOTICE

To prevent damage to the seat warmers and seats:

- Never use a solvent such as paint thinner, benzene, alcohol or gasoline to clean the seats.
- Do not place heavy or sharp objects on seats equipped with seat warmers.
- Do not change the seat cover. It may damage the seat warmer.



While the engine is running, push either of the switches to warm the driver's seat or front passenger's seat (and/or rear passenger's seat).

During mild weather or under conditions where the operation of the seat warmer is not needed, keep the switches in the OFF position.

- Manual temperature control  
Each time you push the switch, the temperature setting of the seat is changed as follows:



- Automatic temperature control  
The seat warmer starts to automatically control the seat temperature in order to prevent low-temperature burns after being manually turned on.

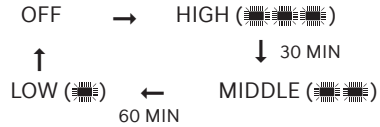

You may manually press the switch to increase seat temperature. However, it soon returns the automatic mode again.

- Auto. Controls That Use Climate Control Settings (for driver's seat)  
The seat warmer automatically controls the seat temperature depending on the ambient temperature when the engine is running.

To use this function, it must be enabled from the Settings menu in the infotainment system screen. Select:

- Setup → Vehicle Settings → Seat → Heated/Ventilated Features → Auto. Controls That Use Climate Control Settings → Seat Warmer/Ventilation
- When pressing the switch for more than 1.5 seconds with the seat warmer operating, the seat warmer will turn OFF.

- If the vehicle is turned off then on again, the seat warmer turns on or off as follows:
  - Driver's seat  
The seat warmer stays OFF if it was turned off before the vehicle was turned off.  
The seat warmer stays ON (HIGH) if it was turned ON (HIGH/MIDDLE/LOW) before the vehicle was turned off.
  - Passenger's seat  
The seat warmer stays OFF regardless of the previous state of the seat warmer.

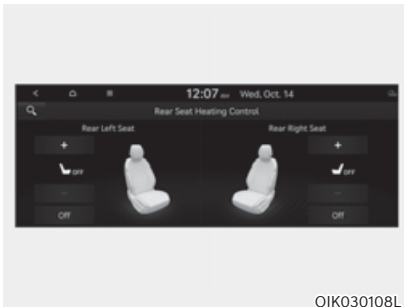

You can also adjust the rear seat warmers from the front seats. With the engine running, touch the seat warmer icon on the infotainment system screen.

## Air Ventilation Seats (if equipped)

The air ventilation seats are provided to cool the front seats by blowing air through small vent holes on the surface of the seat cushions and seatbacks.

When the operation of the air ventilation seat is not needed, keep the air ventilation seats off.

### NOTICE

**To prevent damage to the air ventilation seats:**

- **Never use a solvent such as paint thinner, benzene, alcohol or gasoline to clean the seats.**
- **Avoid spilling liquids on the surface of the front seats and seatbacks; this may cause the air vent holes to become blocked and not work properly.**
- **Do not place materials such as plastic bags or newspapers under the seats. They may block the air intake causing the air vents to not work properly.**
- **Do not change the seat covers. It may damage the air ventilation seat.**
- **If the air vents do not operate, restart the vehicle. If there is no change, have your vehicle inspected by an authorized retailer Genesis Branded products.**

**Front air ventilation seats**

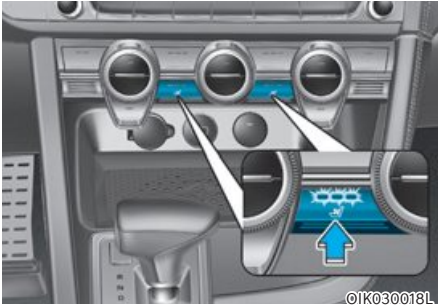

- While the engine is running, push either of the air ventilation seat switch to cool the driver's seat or the front passenger's seat.
- Each time you push the switch, the airflow changes as follows:

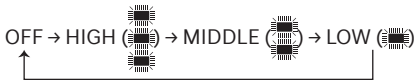

- If the air ventilation seat is positioned at HIGH, the airflow speed will increase according to vehicle speed.
- Use the air ventilation seat with the air conditioning on for more effective ventilation.
- It may take 3–5 minutes after switch operation to feel the temperature change.

- Auto. Controls That Use Climate Control Settings (for driver's seat)  
The air ventilation seat automatically controls the seat temperature depending on the ambient temperature when the engine is running.  
To use this function, it must be enabled from the Settings menu in the infotainment system screen. Select:
  - Setup → Vehicle Settings → Seat → Heated/Ventilated Features → Auto. Controls That Use Climate Control Settings → Seat Warmer/Ventilation
- When pressing the switch for more than 1.5 seconds with the air ventilation seat operating, the operation will turn off.
- If the vehicle is turned off then on again, the air ventilation seat turns ON or OFF as follows:
  - Driver's seat  
The air ventilation seat stays OFF if it was turned off before the vehicle was turned off.  
The air ventilation seat stays ON (HIGH) if it was turned ON (HIGH/MIDDLE/LOW) before the vehicle was turned off.
  - Passenger's seat  
The air ventilation seat stays OFF regardless of the previous state of the air ventilation seat.

## Rear Occupant Alert (ROA) (if equipped)

Rear Occupant Alert is provided to help prevent the driver from leaving the vehicle with the rear passenger left in the vehicle.

### System settings

#### System setting

To use Rear Occupant Alert, it must be enabled from the Settings menu in the infotainment system screen. Select:

- Setup → Vehicle Settings → Convenience → Rear Occupant Alert

**See additional information in supplied Infotainment Manual.**

### System operation

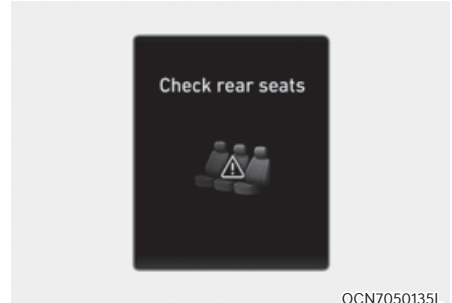

#### Alert

When the driver turns off the engine and opens the driver's door after opening and closing a rear door, a warning message 'Check rear seats' appears.

#### **WARNING**

**Rear Occupant Alert provides information to the driver to check the rear seats but it does not detect whether there is an object or passenger in the back seats. Always make sure to check the rear seats before you leave the vehicle.**

#### **CAUTION**

**The door open and close history is initialized when the driver turns off the engine and locks the vehicle door. Even though the rear door is not opened again, an alert may occur if the previous history is not initialized. For example, if the driver does not lock the vehicle door and opens the door to get off after the alert sounds, the alert may go off.**

## SEAT BELTS

This section describes how to use the seat belts properly. It also describes some of the things not to do when using seat belts.

### Seat Belt Safety Precautions

Always fasten your seat belt and make sure all passengers have fastened their seat belts before starting any trip. Air bags are designed to supplement the seat belt as an additional safety device, but they are not a substitute. Most countries require all occupants of a vehicle to wear seat belts.



#### WARNING

Seat belts must be used by **ALL** passengers whenever the vehicle is moving. Take the following precautions when adjusting and wearing seat belts:

- Children under the age of 13 should be properly restrained in the rear seats.
- **NEVER** allow children to ride in the front passenger seat, unless the air bag is deactivated. If a child is seated in the front passenger seat, move the seat as far back as possible and properly restrain them in the seat.
- **NEVER** allow an infant or child to be carried on an occupant's lap.
- **NEVER** ride with the seatback reclined when the vehicle is moving.
- Do not allow children to share a seat or seat belt.
- Do not wear the shoulder belt under your arm or behind your back.

- **NEVER** wear a seat belt over fragile objects. If there is a sudden stop or impact, the seat belt can damage it.
- Do not use the seat belt if it is twisted. A twisted seat belt will not protect you properly in an accident.
- Do not use a seat belt if the webbing or hardware is damaged.
- Do not latch the seat belt into the buckles of other seats.
- **NEVER** unfasten the seat belt while driving. This may cause loss of vehicle control resulting in an accident.
- Make sure there is nothing in the buckle interfering with the seat belt latch mechanism. This may prevent the seat belt from fastening securely.
- No modifications or additions should be made by the user which will either prevent the seat belt adjusting devices from operating to remove slack, or prevent the seat belt assembly from being adjusted to remove slack.



#### WARNING

Damaged seat belts and seat belt assemblies will not operate properly. Always replace:

- Frayed, contaminated, or damaged webbing.
- Damaged hardware.
- The entire seat belt assembly after it has been worn in an accident, even if damage to webbing or assembly is not apparent.

## Seat Belt Warning Light

### Driver's seat belt warning



#### Driver's seat belt warning

As a reminder to the driver, the seat belt warning light will illuminate for approximately 6 seconds each time the Engine Start/Stop button is in the ON or START position regardless of belt fastening. At this time, if the seat belt is not fastened a warning chime will sound for 6 seconds.

If you continue not to fasten the seat belt and you drive over 6 mph (9 km/h), the warning light will stay illuminated.

If you continue not to fasten the seat belt and you drive over 12 mph (20 km/h) the seat belt warning chime will sound for approximately 100 seconds and the corresponding warning light will blink.

If you unfasten the seat belt while driving under 12 mph (20 km/h), the seat belt warning light will illuminate until the seat belt is fastened.

If you unfasten the seat belt while driving over 12 mph (20 km/h), the seat belt warning chime will sound for approximately 100 seconds and the corresponding warning light will blink.

#### Front passenger's seat belt warning (if equipped)

As a reminder to the front passenger, the front passenger's seat belt warning lights will illuminate for approximately 6 seconds each time the Engine Start/Stop button is in the ON or START position regardless of belt fastening.

If you continue not to fasten the seat belt and you drive over 6 mph (9 km/h), the warning light will stay illuminated.

If you continue not to fasten the seat belt and you drive over 12 mph (20 km/h) the seat belt warning chime will sound for approximately 100 seconds and the corresponding warning light will blink.

If you unfasten the seat belt while driving under 12 mph (20 km/h) the seat belt warning light will illuminate until the seat belt is fastened.

If you unfasten the seat belt while driving over 12 mph (20 km/h), the seat belt warning chime will sound for approximately 100 seconds and the corresponding warning light will blink.



#### WARNING

**Riding in an improper position adversely affects the front passenger's seat belt warning system. It is important for the driver to instruct the passenger to properly be seated as instructed in this manual.**



#### Information

- Although the front passenger seat is not occupied, the seat belt warning light will blink or illuminate for 6 seconds.
- The front passenger's seat belt warning may operate when luggage is placed on the front passenger seat.

## Seat Belt Restraint System



### WARNING

Improperly positioned seat belts may increase the risk of serious injury in an accident. Take the following precautions when adjusting the seat belt:

- Position the lap portion of the seat belt as low as possible across your hips, not on your waist, so that it fits snugly.
- Position one arm under the shoulder belt and the other over the belt, as shown in the illustration.
- Always position the shoulder belt anchor into the locked position at the appropriate height.
- NEVER position the shoulder belt across your neck or face.

### Seat Belt-Driver's 3-point system with emergency locking retractor

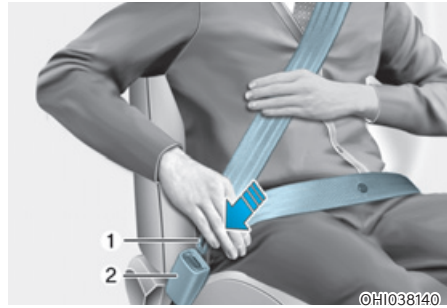

#### To fasten your seat belt:

Pull it out of the retractor and insert the metal tab (1) into the buckle (2). There will be an audible “click” when the tab locks into the buckle.

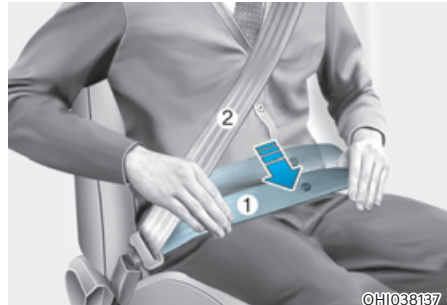

You should place the lap belt (1) portion across your hips and the shoulder belt (2) portion across your chest.

The seat belt automatically adjusts to the proper length after the lap belt portion is adjusted manually so that it fits snugly around your hips. If you lean forward in a slow, easy motion, the belt will extend and move with you.

If there is a sudden stop or impact, the belt will lock into position. It will also lock if you try to lean forward too quickly.



**NOTICE**

If you are not able to smoothly pull enough of the seat belt out from the retractor, firmly pull the seat belt out and release it. After release, you will be able to pull the belt out smoothly.

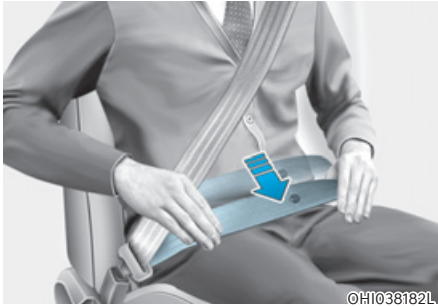
**WARNING**

Improperly positioned seat belts may increase the risk of serious injury in an accident. Take the following precautions when adjusting the seat belt:

- Position the lap portion of the seat belt as low as possible across your hips, not on your waist, so that it fits snugly. This allows your strong pelvic bones to absorb the force of the crash, reducing the chance of internal injuries.
- Position one arm under the shoulder belt and the other over the belt, as shown in the illustration.
- Always position the shoulder belt anchor into the locked position at the appropriate height.
- Never position the shoulder belt across your neck or face.

**Height adjustment**

You can adjust the height of the shoulder belt anchor to one of the four different positions for maximum comfort and safety.

The shoulder portion should be adjusted so it lies across your chest and midway over your shoulder nearest the door, not over your neck.

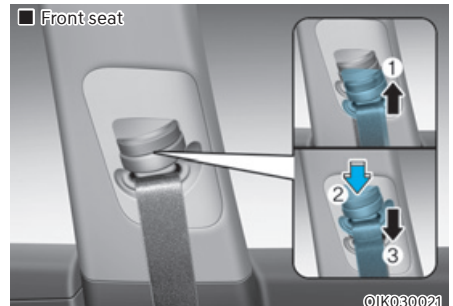

To adjust the height of the seat belt anchor, lower or raise the height adjuster into an appropriate position.

To raise the height adjuster, pull it up (1). To lower it, push it down (3) while pressing the height adjuster button (2).

Release the button to lock the anchor into position. Try sliding the height adjuster to make sure that it has locked into position.

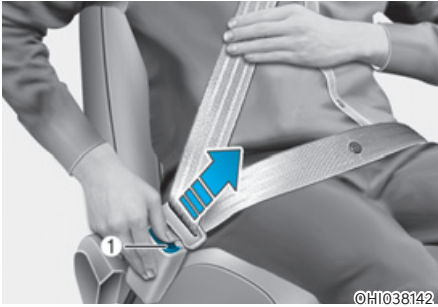

**To release your seat belt:**

Press the release button (1) in the locking buckle.

When it is released, the belt should automatically draw back into the retractor. If this does not happen, check the belt to be sure it is not twisted, then try again.

***Rear Seat Belt – Passenger’s 3-point system with convertible locking retractor***

This type of seat belt combines the features of both an emergency locking retractor seat belt and an automatic locking retractor seat belt. Convertible retractor type seat belts are installed in the rear seat positions to help accommodate the installation of child restraint systems. Although a convertible retractor is also installed in the front passenger seat position, NEVER place any infant/child restraint system in the front seat of the vehicle.

**To fasten your seat belt:**

Pull the seat belt out of the retractor and insert the metal tab into the buckle. There will be an audible “click” when the tab locks into the buckle. When not securing a child restraint, the seat belt operates in the same way as the driver’s seat belt (Emergency Locking Retractor Type). It automatically adjusts to the proper length only after the lap belt portion of the seat belt is adjusted manually so that it fits snugly across your hips.

When the seat belt is fully extended from the retractor to allow the installation of a child restraint system, the seat belt operation changes to allow the belt to retract, but not to extend (Automatic Locking Retractor Type). Refer to the “Using a Child Restraint System” section in this chapter.

**NOTICE**

Although the seat belt retractor provides the same level of protection for seated passengers in either emergency or automatic locking modes, the emergency locking mode allows seated passengers to move freely in their seat while keeping some tension on the belt. During a collision or sudden stop, the retractor automatically locks the belt to help restrain your body.

To deactivate the automatic locking mode, unbuckle the seat belt and allow the belt to fully retract.

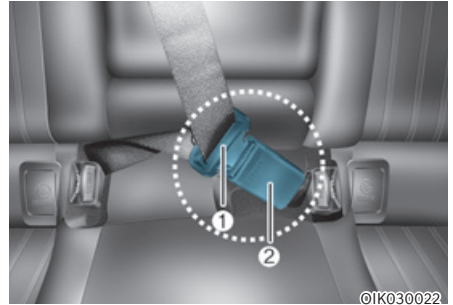
**Rear center seat belt (if equipped)**

1. Take out the buckle (2), which is stored between the seat/seatback cushions.
2. Insert the metal plate (1) into the buckle (2), until it clicks.  
You can make sure its secure fastening by pulling the seatbelt webbing. The buckle with 'CENTER' mark should be used for the 3-point seatbelt.
3. Restore the buckle between the seat/ seatback cushion after unfastening the seatbelt.

### **Pre-tensioner seat belt (Driver and front passenger)**



ODH033058

Your vehicle is equipped with driver's and front passenger's Pre-tensioner Seat Belts (Retractor Pretensioner and Emergency Fastening Device System). The purpose of the pre-tensioner is to make sure the seat belts fit tightly against the occupant's body in certain frontal or side collision(s). The Emergency Fastening Device System may be activated in certain crashes where the frontal or side collision(s) is severe enough, together with the air bags.

When the vehicle stops suddenly, or if the occupant tries to lean forward too quickly, the seat belt retractor will lock into position. In certain frontal or side collision(s), the pre-tensioner will activate and pull the seat belt into tighter contact against the occupant's body.

(1) Retractor Pretensioner

The purpose of the retractor pretensioner is to make sure that the shoulder belts fit in tightly against the occupant's upper body in certain frontal or side collision(s).

(2) Emergency Fastening Device System

The purpose of the Emergency Fastening Device System is to make sure that the pelvis belts fit in tightly against the occupant's lower body in certain frontal or side collision(s).

If the system senses excessive tension on the driver or passenger's seat belt when the pre-tensioner system activates, the load limiter inside the retractor pre-tensioner will release some of the pressure on the affected seat belt.



### **WARNING**

- **Always wear your seat belt and sit properly in your seat.**
- **Do not use the seat belt if it is loose or twisted. A loose or twisted seat belt will not protect you properly in an accident.**
- **Do not place anything near the buckle. This may adversely affect the buckle and cause it to function improperly.**
- **Always replace your pre-tensioners after activation or an accident.**
- **NEVER inspect, service, repair or replace the pre-tensioners yourself. This must be done by an authorized retailer of Genesis Branded products.**
- **Do not hit the seat belt assemblies.**

## WARNING

Do not touch the pre-tensioner seat belt assemblies for several minutes after they have been activated. When the pre-tensioner seat belt mechanism deploys during a collision, the pre-tensioner can become hot and can burn you.

## CAUTION

Body work on the front area of the vehicle may damage the pre-tensioner seat belt system. Therefore, have the system to be serviced by an authorized retailer of Genesis Branded products.

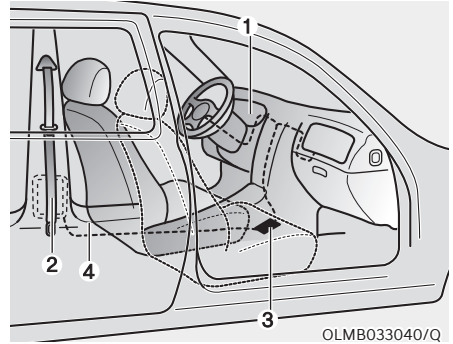

The Pre-Tensioner Seat Belt System consists mainly of the following components. Their locations are shown in the illustration above:

- (1) SRS air bag warning light
- (2) Retractor pre-tensioner
- (3) SRS control module
- (4) Emergency Fastening Device System (if equipped)

## **NOTICE**

The sensor that activates the SRS air bag is connected with the pre-tensioner seat belts. The SRS air bag warning light on the instrument panel will illuminate for approximately 6 seconds after the Engine Start/Stop button is in the ON position, and then it should turn off.

If the pre-tensioner is not working properly, the warning light will illuminate even if the SRS air bag is not malfunctioning. If the warning light does not illuminate, stays illuminated or illuminates when the vehicle is being driven, have an authorized retailer of Genesis Branded products inspect the pre-tensioner seat belts and SRS air bags as soon as possible.

**NOTICE**

- Both the driver's and front passenger's pre-tensioner seat belts may be activated in certain frontal or side collisions or rollovers.
- When the pre-tensioner seat belts are activated, a loud noise may be heard and fine dust, which may appear to be smoke, may be visible in the passenger compartment. These are normal operating conditions and are not hazardous.
- Although it is non-toxic, the fine dust may cause skin irritation and should not be inhaled for prolonged periods. Wash all exposed skin areas thoroughly after an accident in which the pre-tensioner seat belts were activated.

**NOTICE**

The sensor that activates the SRS control module is connected with the pre-tensioner seat belts. The SRS air bag warning light on the instrument cluster will illuminate for approximately three to six seconds after the Engine Start/Stop button is in the ON position, and then it should turn off.

If the pre-tensioner is not working properly, the warning light will illuminate even if the SRS air bag is not malfunctioning. If the warning light does not illuminate, stays illuminated or illuminates when the vehicle is being driven, have the pre-tensioner seat belts and/or SRS control module be inspected by an authorized retailer of Genesis Branded products as soon as possible.

## Information

- Pre-tensioner seat belts may be activated in certain frontal or side collisions or rollover situations (if equipped with rollover sensor).
- When the pre-tensioner seat belts are activated, a loud noise may be heard and fine dust, which may appear to be smoke, may be visible in the passenger compartment. These are normal operating conditions and are not hazardous.
- Although it is non-toxic, the fine dust may cause skin irritation and should not be inhaled for prolonged periods. Wash all exposed skin areas thoroughly after an accident in which the pre-tensioner seat belts were activated.

## WARNING

- Fasten your seat belt while sitting properly in an upright position to maximize the effectiveness of the pre-tensioner seat belt system.
- A pre-tensioner seat belt system is designed to activate only once. Replace the pre-tensioner seat belt system, if it was activated in an accident.

## Additional Seat Belt Safety Precautions

### **Seat belt use during pregnancy**

The seat belt should always be used during pregnancy. The best way to protect your unborn child is to protect yourself by always wearing the seat belt.

Pregnant women should always wear a lap-shoulder seat belt. Place the shoulder belt across your chest, routed between your breasts and away from your neck. Place the lap belt line so that it fits snugly and as low as possible across the hips, not across the abdomen.

## WARNING

- A pregnant woman or a patient is more vulnerable to any impacts on the abdomen during an abrupt stop or accident. If you are in an accident while pregnant, we recommend you consult your doctor.
- To reduce the risk of serious injury or death to an unborn child during an accident, pregnant women should **NEVER** place the lap portion of the seat belt above or over the area of the abdomen where the unborn child is located.

## Seat belt use and children

### Infant and small children

All 50 states have child restraint laws which require children to travel in approved child restraint devices, including booster seats. The age at which seat belts can be used instead of child restraints differs among states, so you should be aware of the specific requirements in your state, and where you are travelling. Infant and child restraints must be properly placed and installed in a rear seat. For more information refer to the “Child Restraint Systems” section in this chapter.



### WARNING

**ALWAYS properly restrain infants and small children in a child restraint appropriate for the child’s height and weight.**

**To reduce the risk of serious injury or death to a child and other passengers, NEVER hold a child in your lap or arms when the vehicle is moving. The violent forces created during an accident tear off the child from and throw the child against the interior of the vehicle.**

Small children are best protected from injury in an accident when properly restrained in the rear seat by a child restraint system that meets the requirements of the Federal Motor Vehicle Safety Standards. Before buying any child restraint system, make sure that it has a label certifying that it meets Federal Motor Vehicle Safety Standard FMVSS 213. The restraint must be appropriate for your child’s height and weight. Check the label on the child restraint for this information. Refer to the “Child Restraint Systems” section in this chapter.

### Larger children

Children under age 13 and who are too large for a booster seat should always occupy the rear seat and use the available lap/shoulder belts. A seat belt should lie across the upper thighs and be snug across the shoulder and chest to restrain the child safely. Check belt fit periodically. A child’s squirming could put the belt out of position. In the event of an accident, children are afforded the best safety restrained by a proper Child Restraint System in the rear seats.

If a larger child over age 13 must be seated in the front seat, the child must be securely restrained by the available lap/shoulder belt and the seat should be placed in the rearmost position.

If the shoulder belt portion slightly touches the child’s neck or face, try placing the child closer to the center of the vehicle. If the shoulder belt still touches their face or neck, they need to be returned to an appropriate booster seat in the rear seat.



### WARNING

- **Always make sure larger children’s seat belts are worn and properly adjusted.**
- **NEVER allow the shoulder belt to contact the child’s neck or face.**
- **Do not allow more than one child to use a single seat belt.**



### ***Seat belt use and injured people***

A seat belt should be used when an injured person is being transported. Consult with a physician for specific recommendations.

#### ***One person per belt***

Two people (including children) should never attempt to use a single seat belt. This could increase the severity of injuries in case of an accident.

#### ***Do not lie down***

Sitting in a reclined position when the vehicle is in motion can be dangerous. Even when buckled up, the protections of your restraint system (seat belts and/or air bags) is greatly reduced by reclining your seatback.

Seat belts must be snug against your hips and chest to work properly.

During an accident, you could be twined with the seat belt, causing neck or other injuries.

The more the seat back is reclined, the greater the chance for the passenger's hips to slide under the lap belt or the passenger's neck to strike the shoulder belt.



### **WARNING**

- **NEVER ride with a reclined seatback when the vehicle is moving.**
- **Riding with a reclined seatback increases your chance of serious or fatal injuries in the event of a collision or sudden stop.**
- **Driver and passengers should always sit well back in their seats, properly belted, and with the seatbacks upright.**

### **Care of Seat Belts**

Seat belt systems should never be disassembled or modified. In addition, care should be taken to assure that seat belts and belt hardware are not damaged by seat hinges, doors or other abuse.

#### ***Periodic inspection***

All seat belts should be inspected periodically for wear or damage of any kind. Any damaged parts should be replaced as soon as possible.

#### ***Keep belts clean and dry***

Seat belts should be kept clean and dry. If belts become dirty, they can be cleaned by using a mild soap solution and warm water. Bleach, dye, strong detergents or abrasives should not be used because they may damage and weaken the fabric.

#### ***When to replace seat belts***

The entire seat belt assembly or assemblies should be replaced if the vehicle has been involved in an accident. This should be done even if no damage is visible. Additional questions concerning seat belt operation should be consulted with to an authorized retailer of Genesis Branded products.

## CHILD RESTRAINT SYSTEM (CRS)

### Children Always in the Rear



#### WARNING

**Always properly restrain children in the rear seats of the vehicle.**

**Children of all ages are safer when restrained in the rear seat. A child riding in the front passenger seat can be forcefully struck by an inflating air bag resulting in SERIOUS INJURY or DEATH.**

Children under age 13 must always ride in the rear seats and must always be properly restrained to minimize the risk of injury in an accident, sudden stop or sudden maneuver. According to accident statistics, children are safer when properly restrained in the rear seats than in the front seat. **Even with air bags, children can be seriously injured or killed.** Children too large for a child restraint must use the seat belts provided.

All 50 states have child restraint laws which require children to travel in approved child restraint devices. The laws governing the age or height/weight restrictions at which seat belts can be used instead of child restraints differs among states, so you should be aware of the specific requirements in your state, and where you are travelling.

Child restraint systems must be properly placed and installed in the rear seat. You must use a commercially available child restraint system that meets the requirements of the Federal Motor Vehicle Safety Standards (FMVSS 213).

Child restraint systems are generally designed to be secured in a vehicle seat by lap belt portion of a lap/shoulder belt, or by a LATCH system in the rear seats of the vehicle.

### *Child restraint system (CRS)*

Infants and younger children must be restrained in an appropriate rear-facing or forward-facing CRS that has first been properly secured to the rear seat of the vehicle. Read and comply with the instructions for installation and use provided by the manufacturer of the child restraint.



#### WARNING

**An improperly secured child restraint can increase the risk of SERIOUS INJURY or DEATH in an accident. Always take the following precautions when using a child restraint system:**

- **NEVER** install a child or infant restraint in the front passenger's seat.
- **Always properly secure the child restraint to a rear seat of the vehicle.**
- **Always follow the child restraint system manufacturer's instructions for installation and use.**
- **Always properly restrain your child in the child restraint.**
- **If the vehicle head restraint prevents proper installation of a child seat (as described in the child restraint system manual), the head restraint of the respective seating position shall be readjusted or entirely removed.**
- **Do not use an infant carrier or a child safety seat that "hooks" over a seatback, it may not provide adequate protection in an accident.**
- **After an accident, have retailer of Genesis Branded products check the child restraint system, seat belts, tether anchors and lower anchors.**

## Selecting a Child Restraint System (CRS)

When selecting a Child Restraint System for your child, always:

- Make sure the CRS has a label certifying that it meets applicable Federal Motor Vehicle Safety Standards (FMVSS 213).
- Select a Child Restraint System based on your child's height and weight. The required label or the instructions for use typically provide this information.
- Select a Child Restraint System that fits the vehicle seating position where it will be used.
- Read and comply with the warnings and instructions for installation and use provided with the Child Restraint System.

### **Child Restraint System types**

There are three main types of Child Restraint Systems: rearward-facing, forward-facing and booster Child Restraint Systems.

They are classified according to the child's age, height and weight.



### **WARNING**

**NEVER** install a child or infant restraint in the front passenger's seat.

**Placing a rear-facing child restraint in the front seat can result in SERIOUS INJURY or DEATH if the child restraint is struck by an inflating air bag.**

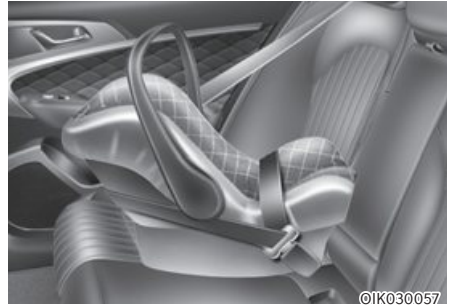

### **Rear-facing child seats**

A rear-facing child seat provides restraint with the seating surface against the back of the child. The harness system holds the child in place, and in an accident, acts to keep the child positioned in the seat and reduce the stress to the neck and spinal cord.

All children under age one must always ride in a rear-facing infant child restraint.

Convertible and 3-in-1 child seats typically have higher height and weight limits for the rear-facing position, allowing you to keep your child rear-facing for a longer period of time.

Continue to use a rear-facing child seat for as long as your child will fit within the height and weight limits allowed by the child seat manufacturer. It's the best way to keep them safe. Once your child has outgrown the rear-facing child restraint, your child is ready for a forward-facing child restraint with a harness.



### **Forward-facing Child Restraint System**

A forward-facing Child Restraint System provides restraint for the child's body with a harness. Keep children in a forward-facing Child Restraint System with a harness until they reach the top height or weight limit allowed by your Child Restraint System's manufacturer.

Once your child outgrows the forward-facing Child Restraint System, your child is ready for a booster seat.

### **Booster seats**

A booster seat is a Child Restraint System designed to improve the fit of the vehicle's seat belt system. A booster seat positions the seat belt so that it fits properly over your child's stronger body parts. Keep your children in booster seats until they are big enough to fit in a seat belt properly.

For a seat belt to fit properly, the lap belt must lie comfortable across the upper thighs, not the stomach. The shoulder belt should lie comfortable across the shoulder and chest and not across the neck or face. Children under age 13 must always be properly restrained to minimize the risk of injury in an accident, sudden stop or sudden maneuver.

## Installing a Child Restraint System (CRS)



### WARNING

Before installing your child restraint system always:

- Read and follow the instructions provided by the manufacturer of the child restraint.
- Read and follow the instructions regarding child restraint systems in this manual.

Failure to follow all warnings and instructions could increase the risk of the **SERIOUS INJURY** or **DEATH** if an accident occurs.



### WARNING

If the vehicle head restraint prevents proper installation of a child seat as described in the child seat system manual, the head restraint of the respective seating position shall be readjusted or entirely removed.

After selecting a proper child seat for your child, check to make sure it fits properly in your vehicle. Follow the instructions provided by the manufacturer when installing the child seat. Note these general steps when installing the seat to your vehicle:

- **Properly secure the child restraint to the vehicle.** All child restraints must be secured to the vehicle with the lap part of a lap/shoulder belt or with the LATCH system.
- **Make sure the child restraint is firmly secured.** After installing a child restraint to the vehicle, push and pull the seat forward-and-back and side-to-side to verify that it is securely attached to the seat. A child restraint secured with a seat belt should be installed as firmly as possible. However, some side-to-side movement can be expected.
- **Secure the child in the child restraint.** Make sure the child is properly strapped in the child restraint according to the manufacturer instructions.



### CAUTION

A child restraint in a closed vehicle can become very hot. To prevent burns, check the seating surface and buckles before placing your child in the child restraint.

### Lower Anchors and Tether for Children (LATCH System)

The LATCH system holds a child restraint during driving and in an accident. This system is designed to make installation of the child restraint easier and reduce the possibility of improperly installing your child restraint. The LATCH system uses anchors in the vehicle and attachments on the child restraint. The LATCH system eliminates the need to use seat belts to secure the child restraint to the rear seats.

Lower anchors are metal bars built into the vehicle. There are two lower anchors for each LATCH seating position that will accommodate a child restraint with lower attachments.

To use the LATCH system in your vehicle, you must have a child restraint with LATCH attachments.

The child seat manufacturer will provide you with instructions on how to use the child seat with its attachments for the LATCH lower anchors.

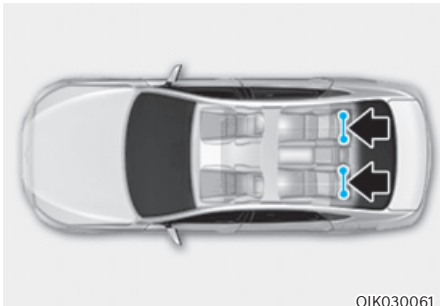

LATCH anchors have been provided in the left and right outboard rear seating positions. Their locations are shown in the illustration. There are no LATCH anchors provided for the center rear seating position.

### WARNING

**Do not attempt to install a child restraint system using LATCH anchors in the rear center seating position. There are no LATCH anchors provided for this seat. Using the outboard seat anchors can damage the anchors which may break or fail in a collision resulting in serious injury or death.**

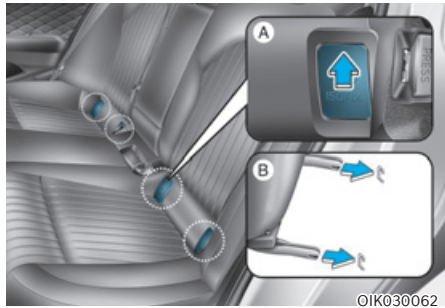

[A]: Lower Anchorage Position Indicator,  
[B]: Lower Anchorage

The lower anchor position indicator symbols are located on the left and right rear seat backs to identify the position of the lower anchors in your vehicle (see arrows in illustration).

The LATCH anchors are located between the seatback and the seat cushion of the rear seat left and right outboard seating positions.

### Securing a child restraint with the LATCH anchors system

To install a LATCH-compatible child restraint in either of the rear outboard seating positions:

1. Move the seat belt buckle away from the lower anchors.
2. Move any other objects away from the anchors that could prevent a secure connection between the child restraint and the lower anchors.
3. Place the child restraint on the vehicle seat, then attach the seat to the lower anchors according to the instructions provided by the child restraint manufacturer.
4. Follow the child restraint instructions for properly adjusting and tightening the lower attachments on the child restraint to the lower anchors.



### WARNING

Take the following precautions when using the LATCH system:

- Read and follow all installation instructions provided with your child restraint system.
- To prevent the child from reaching and taking hold of unretracted seat belts, buckle all unused rear seat belts and retract the seat belt webbing behind the child. Children can be strangled if a shoulder belt becomes wrapped around their neck and the seat belt tightens.
- NEVER attach more than one child restraint to a single anchor. This could cause the anchor or attachment to come loose or break.
- Always have the LATCH system inspected by an authorized retailer of Genesis Branded products after an accident. An accident can damage the LATCH system and may not properly secure the child restraint.

### NOTICE

The recommended weight for the LATCH system is under 65 lb (30 kg).

How to determine an appropriate child restraint weight:

**Child weight + Child restraint weight < 65 lb (30kg)**

### Securing a child restraint seat with “Tether Anchor” system

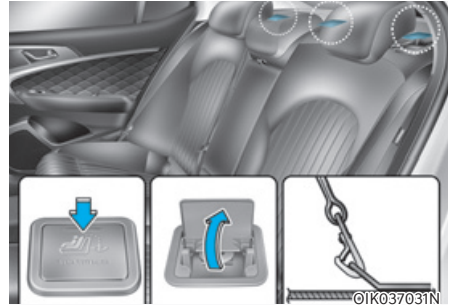

First secure the child restraint with the LATCH lower anchors or the seat belt. If the child restraint manufacturer recommends that the top tether strap be attached, attach and tighten the top tether strap to the top tether strap anchor.

Child restraint hook holders are located on the rear of the seatbacks.



## WARNING

Take the following precautions when installing the tether strap:

- Read and follow all installation instructions provided with your child restraint system.
- **NEVER** attach more than one child restraint to a single tether anchor. This could cause the anchor or attachment to come loose or break.
- Do not attach the tether strap to anything other than the correct tether anchor. It may not work properly if attached to something else.
- Do not use the tether anchors for adult seat belts or harnesses, or for attaching other items or equipment to the vehicle.



To install the tether anchor:

1. Route the child restraint tether strap over the child restraint seatback. Route the tether strap under the head restraint and between the head restraint posts, or route the tether strap over the top of the vehicle seatback. Make sure the strap is not twisted.
2. Connect the tether strap hook to the tether anchor, then tighten the tether strap according to the child seat manufacturer's instructions to firmly secure the child restraint to the seat.
3. Check that the child restraint is securely attached to the seat by pushing and pulling the seat forward-and-back and side-to-side.



### **Securing a child restraint with lap/shoulder belt**

When not using the LATCH system, all child restraints must be secured to a vehicle rear seat with the lap part of a lap/shoulder belt.



#### **WARNING**

**ALWAYS** place a rear-facing child restraint in the rear seat of the vehicle.

**Placing a rear-facing child restraint in the front seat can result in serious injury or death if the child restraint is struck by an inflating air bag.**

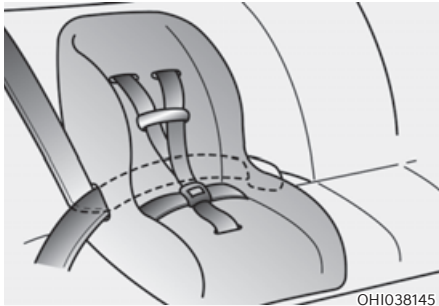

OHI038145

#### **Automatic locking mode**

Since all passenger seat belts move freely under normal conditions and only lock under extreme or emergency conditions (emergency locking mode), you must manually pull the seat belt all the way out to shift the retractor to the “Automatic Locking” mode to secure a child restraint.

The “Automatic Locking” mode will help prevent the normal movement of the child in the vehicle from causing the seat belt to loosen and compromise the child restraint system. To secure a child restraint system, use the following procedure.

To install a child restraint system on the rear seats, do the following:

1. Place the child restraint system on a rear seat and route the lap/shoulder belt around or through the child restraint, following the restraint manufacturer’s instructions. Be sure the seat belt webbing is not twisted.



#### **Information**

**When using the rear center seat belt, you should also refer to the “Rear Seat Belt – Passenger’s 3-point system” section in this chapter.**

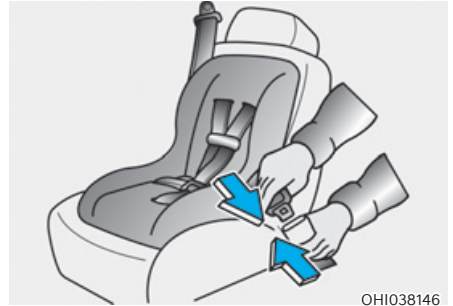

OHI038146

2. Fasten the lap/shoulder belt latch into the buckle. Listen for the distinct “click” sound.

**i** Information

**Position the release button so that it is easy to access in case of an emergency.**

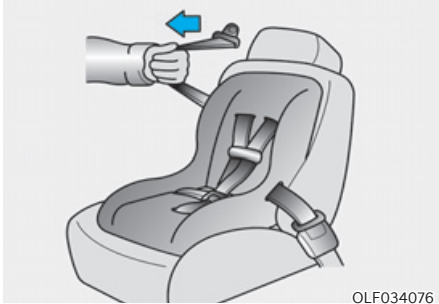

3. Pull the shoulder portion of the seat belt all the way out. When the shoulder portion of the seat belt is fully extended, it will shift the retractor to the “Automatic Locking” (child restraint) mode.



4. Slowly allow the shoulder portion of the seat belt to retract and listen for an audible “clicking” or “ratcheting” sound. This indicates that the retractor is in the “Automatic Locking” mode. If no distinct sound is heard, repeat steps 3 and 4.
5. Remove as much slack from the belt as possible by pushing down on the child restraint system while feeding the shoulder belt back into the retractor.

6. Push and pull on the child restraint system to confirm that the seat belt is holding it firmly in place. If it is not, release the seat belt and repeat steps 2 through 6.
7. Double check that the retractor is in the “Automatic Locking” mode by attempting to pull more of the seat belt out of the retractor. If you cannot, the retractor is in the “Automatic Locking” mode.

If your CRS (child restraint system) manufacturer instructs or recommends you to use a tether anchor with the lap/shoulder belt, refer to the previous pages for more information.

**i** Information

**When the seat belt is allowed to retract to its fully stowed position, the retractor will automatically switch from the “Automatic Locking” mode to the emergency lock mode for normal adult usage.**

**⚠** WARNING

**If the retractor is not in the “Automatic Locking” mode, the child restraint can move when your vehicle turns or stops suddenly. A child can be seriously injured or killed if the child restraint is not properly anchored in the car, including manually pulling the seat belt all the way out to shift the retractor to the “Automatic Locking” mode.**

To remove the child restraint, press the release button on the buckle and then pull the lap/shoulder belt out of the restraint and allow the seat belt to retract fully.

## AIR BAG - SUPPLEMENTAL RESTRAINT SYSTEM

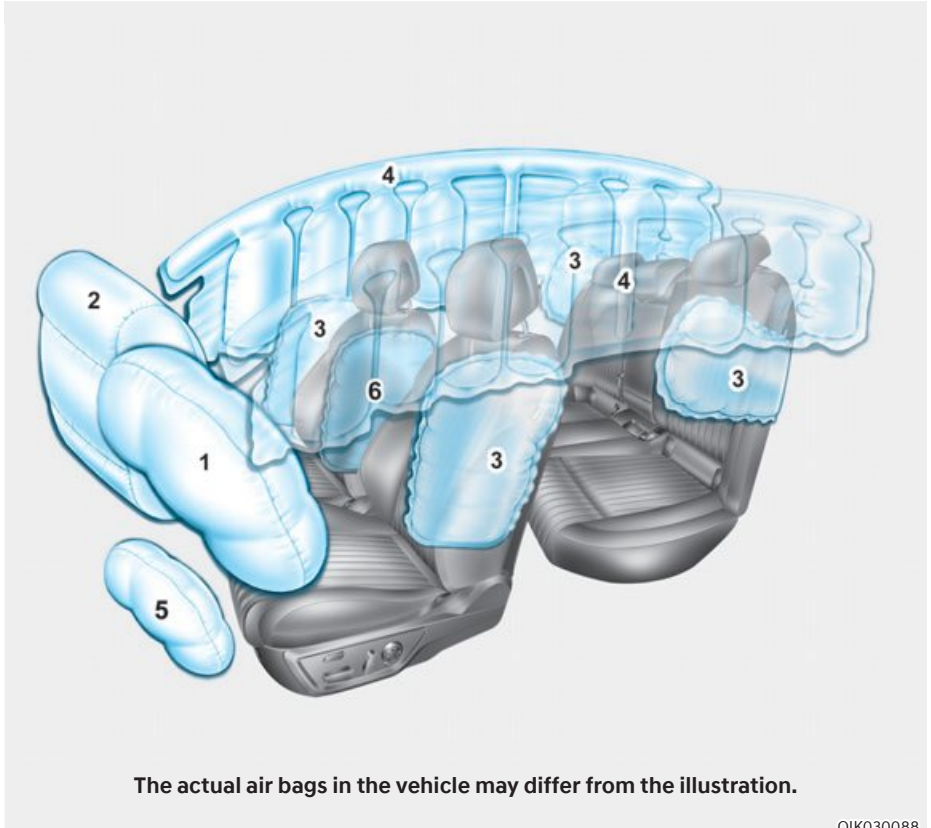

1. Driver's front air bag
2. Passenger's front air bag
3. Side air bag
4. Curtain air bag
5. Driver's knee air bag
6. Front center air bag

The vehicles are equipped with a Supplemental Air Bag System for the driver's seat and front passenger's seats.

The front air bags are designed to supplement the three-point seat belts. For these air bags to provide protection, the seat belts must be worn at all times when driving.

You can be severely injured or killed in an accident if you are not wearing a seat belt. Air bags are designed to supplement seat belts, but do not replace them. Also, air bags are not designed to deploy in every collision. In some accidents, the seat belts are the only restraint protecting you.



### **WARNING**

#### **AIR BAG SAFETY PRECAUTIONS**

**ALWAYS** use seat belts Child Restraint Systems - every trip, every time, everyone! Even with air bags, you can be seriously injured or killed in a collision if you are improperly belted or not wearing your seat belt when the air bag inflates.

**NEVER** place a child in any Child Restraint System or booster seat in the front passenger seat, unless the air bag is deactivated.

An inflating air bag could forcefully strike the infant or child causing serious or fatal injuries.

**ABC - Always Buckle Children** under age 13 in the back seat. It is the safest place for children of any age to ride. If a child age 13 or older must be seated in the front seat, he or she must be properly belted and the seat should be moved as far back as possible.

All occupants should sit upright with the seatback in an upright position, centered on the seat cushion with their seat belt on, legs comfortably extended and their feet on the floor until the vehicle is parked and the vehicle is turned off. If an occupant is out of position during an accident, the rapidly deploying air bag may forcefully contact the occupant causing serious or fatal injuries.

You and your passengers should never sit or lean unnecessarily close to the air bags or lean against the door or center console.

Move your seat as far back as possible from front air bags, while still maintaining control of the vehicle. The U.S. National Highway Traffic Safety Administration (NHTSA) recommends that drivers allow at least 10 in. (25 cm) between the center of the steering wheel and the chest.

## Where are the Air Bags?

### Driver's and passenger's front air bags

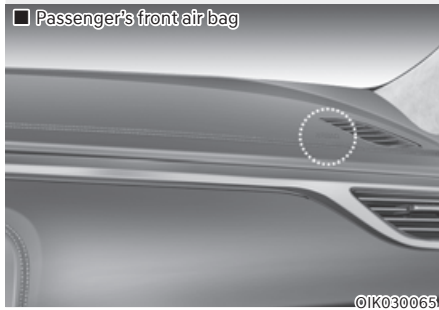
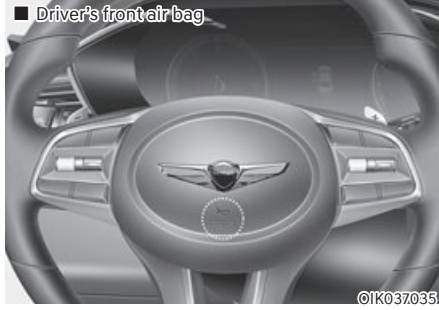

Your vehicle is equipped with a Supplemental Restraint System (SRS) and lap/shoulder belts at both the driver and passenger seating positions.

The SRS consists of air bags which are located in the center of the steering wheel, in the driver's side lower crash pad below the steering wheel, and the passenger's side front panel pad above the glove box.

The air bags are labeled with the letters "AIR BAG" embossed on the pad covers.

The purpose of the SRS is to provide the vehicle's driver and front passengers with additional protection than that offered by the seat belt system alone. The SRS uses sensors to gather information about the driver's and front passenger's seat belt usage and impact severity. The seat belt buckle sensors determine if the driver and front passenger's seat belts are fastened. These sensors provide the ability to control the SRS deployment based on whether or not the seat belts are fastened, and how severe the impact is. The advanced SRS offers the ability to control the air bag inflation within two levels. A first stage level is provided for moderate-severity impacts. A second stage level is provided for more severe impacts. According to the impact severity, and seat belt usage, the SRS Control Module (SRSCM) controls the air bag inflation. Failure to properly wear seat belts can increase the risk or severity of injury in an accident.

 **WARNING**

To reduce the risk of serious injury or death from inflating front air bags, take the following precautions:

- Seat belts must be worn at all times to help keep occupants positioned properly.
- Move your seat as far back as possible from front air bags, while still maintaining control of the vehicle.
- Never lean against the door or center console.
- Do not allow the front passenger to place their feet or legs on the dashboard.
- No objects (such as crash pad cover, mobile phone holder, cup holder, perfume or stickers) should be placed over or near the air bag modules on the steering wheel, instrument panel, windshield glass, and the front passenger's panel above the glove box. Such objects could cause harm if the vehicle is in a crash severe enough to cause the air bags to deploy.
- Do not attach any objects on the front windshield and inside mirror.

**Side air bags and front center air bag**

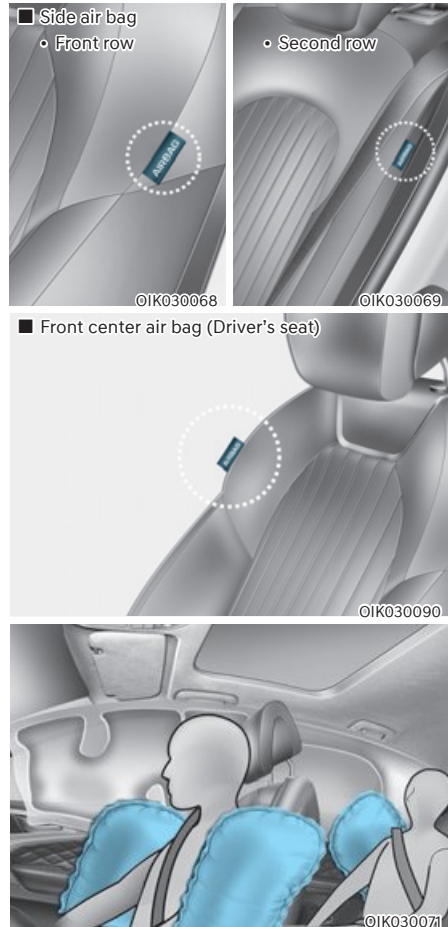

Your vehicle is equipped with a side air bag in each front and outboard second row seat. Additionally, a front center air bag is provided in the inboard side of the driver seatback. The purpose of the air bag is to provide the vehicle's additional protection than that offered by the seat belt alone.

The side air bags and front center air bag are designed to deploy during certain side impact collisions, depending on the crash severity.

For vehicles equipped with a rollover sensor the front center air bag, side and/or curtain air bags and pre-tensioners on both sides of the vehicle may deploy if a rollover or possible rollover is detected.

The side air bags and front center air bag are not designed to deploy in all side impact or rollover situations.



### **WARNING**

To reduce the risk of serious injury or death from an inflating side air bag and front center air bag, take the following precautions:

- **Do not place any objects over the air bag or between the air bag and yourself. Also, do not attach any objects around the area the air bag inflates such as the door, side door glass, front and rear pillar.**
  - **Do not place any objects between the door and the seat. They may become dangerous projectiles if the side air bag inflates.**
  - **Do not install any accessories on the side or near the side air bags.**
  - **Do not cause impact to the doors when the Engine Start/Stop button is in the ON or START position as this may cause the side air bags to inflate.**
  - **If the seat or seat cover is damaged, have the system be serviced by an authorized retailer of Genesis Branded products.**
- **Seat belts must be worn at all times to help keep occupants positioned properly.**
  - **Do not allow passengers to lean their heads or bodies onto doors, put their arms on the doors, stretch their arms out of the window, or place objects between the doors and seats.**
  - **Hold the steering wheel at the 9 o'clock and 3 o'clock positions, to minimize the risk of injuries to your hands and arms.**
  - **Do not use any accessory seat covers. This could reduce or prevent the effectiveness of the system.**
  - **Do not hang other objects except clothes. In an accident it may cause vehicle damage or personal injury especially when air bag is inflated.**

### Curtain air bags

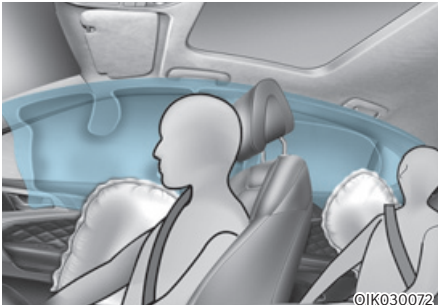

Curtain air bags are located along both sides of the roof rails above the front and rear doors.

They are designed to help protect the heads of the front seat occupants and the rear outboard seat occupants in certain side impact collisions.

The curtain air bags are designed to deploy during certain side impact collisions, depending on the crash severity.

For vehicles equipped with a rollover sensor the side and/or curtain air bags and pre-tensioners on both sides of the vehicle may deploy if a rollover or possible rollover is detected.

The curtain air bags are not designed to deploy in all side impact or rollover situations.

### **WARNING**

To reduce the risk of serious injury or death from an inflating curtain air bag, take the following precautions:

- All seat occupants must wear seat belts at all times to help keep occupants positioned properly.
- Properly secure Child Restraint System as far away from the door as possible.
- Do not place any objects over the air bag. Also, do not attach any objects around the area the air bag inflates such as the door, side door glass, front and rear pillar, roof side rail.
- Do not hang other objects except clothes, especially hard or breakable objects.

In an accident, it may cause vehicle damage or personal injury.

- Do not allow passengers to lean their heads or bodies onto doors, put their arms on the doors, stretch their arms out of the window, or place objects between the doors and seats.
- Do not open or repair the side curtain air bags.



## How does the Air Bags System Operate?

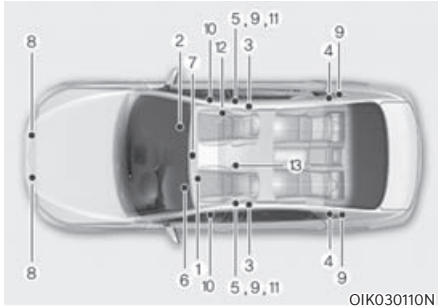

The SRS consists of the following components:

- (1) Driver's front air bag module / Driver's knee air bag module
  - (2) Passenger's front air bag module
  - (3) Side air bag modules
  - (4) Curtain air bag modules
  - (5) Retractor pre-tensioner assemblies
  - (6) Air bag warning light
  - (7) SRS control module (SRSCM) / Rollover sensor
  - (8) Front impact sensors
  - (9) Side impact sensors (acceleration)
  - (10) Side impact sensors (pressure)
  - (11) Emergency Fastening Device System
  - (12) Occupant classification system
  - (13) Front center air bag module
- \* Front passenger's air bag OFF lamp is located on the overhead console.

The SRSCM (Supplemental Restraint System Control Module) continually monitors all SRS components while the Engine Start/Stop button is ON to determine if a crash impact is severe enough to require air bag deployment or pre-tensioner seat belt deployment.



### SRS warning light

The SRS (Supplemental Restraint System) air bag warning light on the instrument panel displays the air bag symbol depicted in the illustration. The system checks the air bag electrical system for malfunctions. The light indicates that there is a potential problem with your air bag system, which could include your side and/or curtain air bags used for rollover protection (if equipped with rollover sensor).



## WARNING

**If your SRS malfunctions, the air bag may not inflate properly during an accident increasing the risk of serious injury or death.**

**If any of the following conditions occur, your SRS is malfunctioning:**

- **The light does not turn on for approximately three to 6 seconds when the Engine Start/Stop button is in the ON position.**
- **The light stays on after illuminating for approximately three to six seconds.**
- **The light comes on while the vehicle is in motion.**
- **The light blinks when the engine is running.**

**Have authorized retailer of Genesis Branded products inspect the SRS as soon as possible if any of these conditions occur.**

During a moderate to severe frontal collision, sensors will detect the vehicle's rapid deceleration. If the rate of deceleration is high enough, the control unit will inflate the front air bags, at the time and with the force needed.

The front air bags help protect the driver and front passenger by responding to frontal impacts in which seat belts alone cannot provide adequate restraint. When needed, the side air bags help provide protection in the event of a side impact or rollover by supporting the side upper body area.

- Air bags are activated (able to inflate if necessary) only when the Engine Start/Stop button is in the ON or START position.
- Air bags inflate in the event of certain frontal or side collisions to help protect the occupants from serious physical injury.
- There is no single speed at which the air bags will inflate. Generally, air bags are designed to inflate based upon the severity of a collision and its direction. These two factors determine whether the sensors produce an electronic deployment/inflation signal.
- The front air bags will completely inflate and deflate in an instant. It is virtually impossible for you to see the air bags inflate during an accident. It is much more likely that you will simply see the deflated air bags hanging out of their storage compartments after the collision.

- In addition to inflating in serious side collisions, vehicles equipped with a rollover sensor, side and/or curtain air bags and front center air bag will inflate if the sensing system detects a rollover.

When a rollover is detected, curtain air bags will remain inflated longer to help provide protection from ejection, especially when used in conjunction with the seat belts. (if equipped with a rollover sensor)

- To help provide protection, the air bags must inflate rapidly. The speed of air bag inflation is a consequence of extremely short time in which to inflate the air bag between the occupant and the vehicle structures before the occupant impacts those structures. This speed of inflation reduces the risk of serious or life-threatening injuries and is thus a necessary part of air bag design. However, the rapid air bag inflation can also cause injuries which can include facial abrasions, bruises and broken bones because the inflation speed also causes the air bags to expand with a great deal of force.
- There are even circumstances under which contact with the air bag can cause fatal injuries, especially if the occupant is positioned excessively close to the air bag.

You can take steps to help reduce the risk of being injured by an inflating air bag. The greatest risk is sitting too close to the air bag. An air bag needs about 10 inches (25 cm) of space to inflate. NHTSA recommends that drivers allow at least 10 inches (25 cm) between the center of the steering wheel and the chest.



## WARNING

To reduce the risk of serious injury or death from an inflating air bag, take the following precautions:

- **NEVER** place a child restraint in the front passenger seat.  
Always properly restrain children under age 13 in the rear seats of the vehicle.
- **Adjust the front passenger's and driver's seats as far to the rear as possible while allowing you to maintain full control of the vehicle.**
- **Hold the steering wheel with hands at the 9 o'clock and 3 o'clock positions.**
- **NEVER** place anything or anyone between the air bag and the seat occupant.
- **Do not allow the front passenger to place their feet or legs on the dashboard.**

■ Driver's front air bag (1)

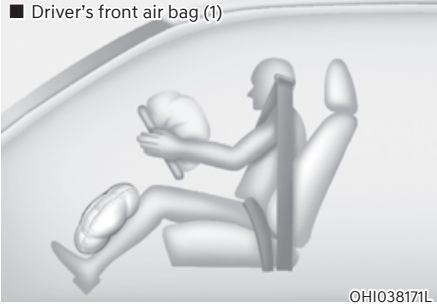

When the SRSCM detects a sufficiently severe impact to the front of the vehicle, it will automatically deploy the front air bags.

■ Driver's front air bag (2)

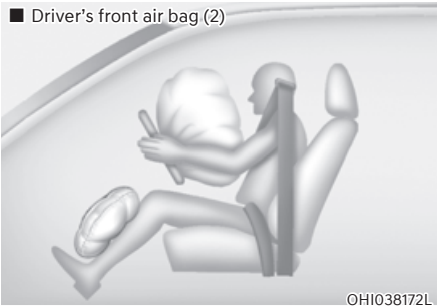

Upon deployment, tear seams molded directly into the pad covers will separate under pressure from the expansion of the air bags. Further opening of the covers allows full inflation of the air bags.

A fully inflated air bag, in combination with a properly worn seat belt, slows the driver's or the front passenger's forward motion, reducing the risk of head and chest injury.

■ Driver's front air bag (3)

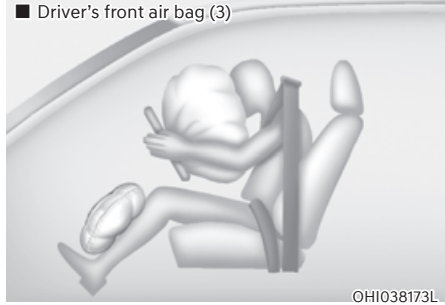

■ Passenger's front air bag



After complete inflation, the air bag immediately starts deflating, enabling the driver to maintain forward visibility and the ability to steer or operate other controls.

### **WARNING**

**To prevent objects from becoming dangerous projectiles when the passenger's air bag inflates:**

- Do not install or place any objects (drink holder, CD holder, stickers, etc.) on the front passenger's panel above the glove box where the passenger's air bag is located.
- Do not install a container of liquid air freshener near the instrument cluster or on the instrument panel surface.

## What to Expect After an Air Bag Inflates

After a frontal or side air bag inflates, it will deflate very quickly. Air bag inflation will not prevent the driver from seeing out of the windshield or being able to steer. Curtain air bags may remain partially inflated for some time after they deploy.



### **WARNING**

**After an air bag inflates, take the following precautions:**

- **Open your windows and doors as soon as possible after impact to reduce prolonged exposure to the smoke and powder released by the inflating air bag.**
- **Do not touch the air bag storage area's internal components immediately after an air bag has inflated. The parts that come into contact with an inflating air bag may be very hot.**
- **Always wash exposed skin areas thoroughly with cold water and mild soap.**
- **Have an authorized retailer of Genesis Branded products replace the air bag immediately after deployment. Air bags are designed to be used only once.**

## ***Noise and smoke from inflating air bag***

When the air bags inflate, they make a loud noise and may produce smoke and powder in the air inside of the vehicle. This is normal and is a result of the ignition of the air bag inflator. After the air bag inflates, you may feel substantial discomfort in breathing because of the contact of your chest with both the seat belt and the air bag, as well as from breathing the smoke and powder. The powder may aggravate asthma for some people. If you experience breathing problems after an air bag deployment, seek medical attention immediately.

Though the smoke and powder are nontoxic, they may cause irritation to the skin, eyes, nose, throat, etc. If this is the case, wash and rinse with cold water immediately and seek medical attention if the symptoms persist.

## Occupant Classification System (OCS)



Your vehicle is equipped with an Occupant Classification System (OCS) in the front passenger's seat.

### **Main components of the Occupant Classification System**

- A detection device located within the front passenger seat cushion.
- Electronic system to determine whether the passenger air bag systems should be activated or deactivated.
- An indicator light located on the overhead console the words “PASSENGER AIR BAG OFF” indicating the front passenger air bag system is deactivated.
- The air bag light on the overhead console is interconnected with the OCS.

The OCS is designed to help detect the presence of a properly-seated front passenger and determine if the passenger's front air bag should be enabled (may inflate) or not.

The purpose is to help reduce the risk of injury or death from an inflating air bag to certain front passenger seat occupants, such as children, by requiring the air bag to be automatically turned OFF.

For example, if a child restraint of the type specified in the regulations is on the seat, the occupant classification sensor can detect it and cause the air bag to turn OFF.

Front passenger seat adult occupants who are properly seated and wearing the seat belt properly, should not cause the passenger air bag to be automatically turned OFF. For smaller adults it may turn off. However, if the occupant does not sit in the seat properly (for example, by not sitting upright, by sitting on the edge of the seat, or by otherwise being out of position), this could cause the sensor to turn the air bag OFF.

You will find the “PASSENGER AIR BAG OFF” indicator on the overhead console. This system detects the conditions 1-4 in the following table and activates or deactivates the front passenger air bag based on these conditions.

Always be sure that you and all vehicle occupants are seated properly and wearing the seat belt properly for the most effective protection by the air bag and the seat belt.

The OCS may not function properly if the passenger takes actions which can affect the classification system. These include:

- Failing to sit in an upright position.
- Leaning against the door or center console.
- Sitting towards the sides of the front of the seat.
- Putting their legs on the dashboard or resting them on other locations which reduce the passenger weight on the front seat.
- Wearing the seat belt improperly.
- Reclining the seatback.
- Wearing a thick clothes like ski wear or hip protection wear.
- Putting an additional thick cushion on the seat.
- Putting electrical devices (e.g. notebook, satellite radio) on the seat with inverter charging.

### Condition and operation in the front passenger Occupant Classification System

Condition detected by the occupant classification system	Indicator/Warning light		Devices
	“PASSENGER AIR BAG OFF” indicator light	SRS warning light	Front passenger air bag
1. Adult *1	Off	Off	Activated
2. Infant *2 or child restraint system with 12 months old *3 *4	On	Off	Deactivated
3. Unoccupied	On	Off	Deactivated
4. Malfunction in the system	Off	On	Activated

\*1: The system judges a person of adult size as an adult. When a smaller adult sits in the front passenger seat, the system may recognize him/her as a child depending on his/her physique and posture.

\*2: Do not allow children to ride in the front passenger seat. When a larger child who has outgrown a child restraint system sits in the front passenger seat, the system may recognize him/her as an adult depending upon his/her physique or sitting position.

\*3: Never install a child restraint system on the front passenger seat.

\*4: The PASSENGER AIR BAG “OFF” indicator may turn on or off when a child above 12 months to 12 years old (with or without child restraint system) sits in the front passenger seat. This is a normal condition.

 **WARNING**

Riding in an improper position or placing weight on the front passenger's seat when it is unoccupied by a passenger adversely affects the OCS. To reduce the risk of serious injury or death:



- **NEVER** put a heavy load in the front seat or seatback pocket, or hang any items on the front passenger seat.



- **NEVER** place your feet on the front passenger seatback.



- **NEVER** sit with your hips shifted towards the front of the seat.



- **NEVER** ride with the seatback reclined when the vehicle is moving.



- **NEVER** place your feet or legs on the dashboard.





- **NEVER** lean on the door or center console or sit on one side of the front passenger seat.



- Do not sit on the passenger seat wearing heavily padded clothes such as ski wear and hip protector.



- Do not use car seat accessories such as thick blankets and cushions which cover up the car seat surface.



- Do not place electronic devices such as laptops, DVD player, or conductive materials such as water bottles on the passenger seat.
- Do not use electronic devices such as laptops and satellite radios which use inverter chargers.



- If large quantity of liquid has been spilled on the passenger seat, the air bag warning light may illuminate or malfunction. Therefore, make sure the seat has been completely dried before driving the vehicle.

- Do not place sharp objects on the front passenger seat. These may damage the occupant detection system, if they puncture the seat cushion.
- Do not place any items under the front passenger seat.
- When changing or replacing the seat or seat cover, use original items only. The OCS has been developed based on using original Genesis Branded products car seats only. Altering or changing the authentic parts may result in system malfunction and increase risk of injury when in collision. Any of the above could interfere with the proper operation of the OCS sensor thereby increasing the risk of an injury in an accident.

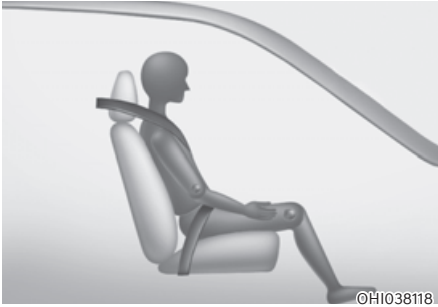

### Proper seated position for OCS

If the “PASSENGER AIR BAG OFF” indicator is on when an adult is seated in the front passenger seat, place the Engine Start/Stop button in the OFF position and ask the passenger to sit properly (sitting upright with the seat back in an upright position, centered on the seat cushion with their seat belt on, legs comfortably extended and their feet on the floor). Restart the engine and have the person remain in that position. This will allow the system to detect the person and to enable the passenger air bag. If the “PASSENGER AIR BAG OFF” indicator is still on, ask the passenger to move to the rear seat.

### **WARNING**

**NEVER** allow an adult passenger to ride in the front passenger seat when the “PASSENGER AIR BAG OFF” indicator is illuminated. During a collision, the air bag will not inflate if the indicator is illuminated. Have your passenger reposition themselves in the seat. If the “PASSENGER AIR BAG OFF” indicator remains illuminated after the passenger repositions themselves properly and the vehicle is restarted, have the passenger move to the rear seat because the air bag will not inflate.

### **NOTICE**

The “PASSENGER AIR BAG OFF” indicator generally illuminates for approximately 4 seconds after the Engine Start/Stop button is in the ON position or after the engine is started. If the front passenger seat is occupied, the OCS will then classify the front passenger after several more seconds.

### **Do Not Install a Child Restraint in the Front Passenger's Seat**



Even though your vehicle is equipped with the OCS, never install a child restraint in the front passenger's seat. An inflating air bag can forcefully strike a child or child restraint resulting in serious or fatal injury.

#### **WARNING**

- **NEVER** place a rear-facing or front-facing child restraint in the front passenger's seat of the vehicle.
- An inflating frontal air bag could forcefully strike a child resulting in serious injury or death.
- Always properly restrain children in an appropriate child restraint in the rear seat of the vehicle.

### **Why Didn't My Air Bag Go Off in a Collision?**

Air bags are not designed to inflate in every collision. There are certain types of accidents in which the air bag would not be expected to provide additional protection. These include rear impacts, second or third collisions in multiple impact accidents, as well as low speed impacts. Damage to the vehicle indicates a collision energy absorption, and is not an indicator of whether or not an air bag should have inflated.

#### **WARNING**

**To reduce the risk of an air bag deploying unexpectedly and causing serious injury or death:**

- Do not hit or allow any objects to impact the locations where air bags or sensors are installed.
- Do not perform maintenance on or around the air bag sensors. If the location or angle of the sensors is altered, the air bags may deploy when they should not or may not deploy when they should.
- Do not install bumper guards or replace the bumper with a non-genuine part. This may adversely affect the collision and air bag deployment performance.
- Press the Engine Start/Stop button to the OFF or ACC position, when the vehicle is being towed to prevent inadvertent air bag deployment.
- Have all air bag repairs conducted by an authorized retailer of Genesis Branded products.

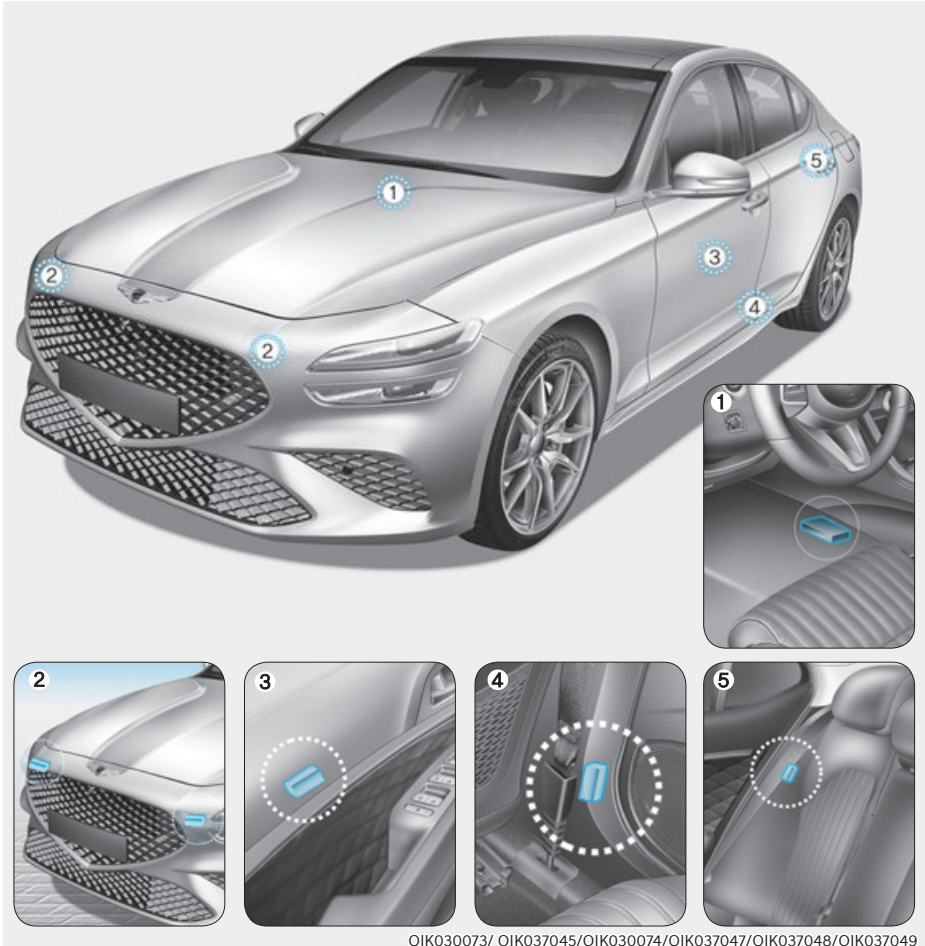

- 1. SRS control module / Rollover sensor
- 2. Front impact sensor
- 3. Side impact sensor (Pressure)

- 4. Side impact sensor (Acceleration)
- 5. Side impact sensor (Acceleration)

## Air bag inflation conditions



### Front air bags

Front air bags are designed to inflate in a frontal collision depending on the severity of impact of the front collision.

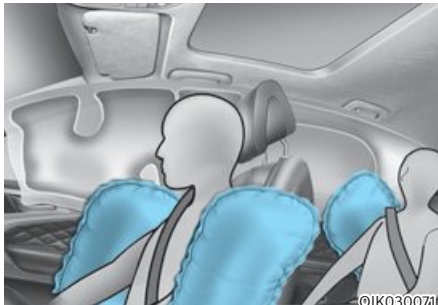
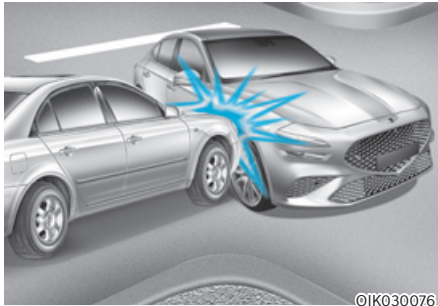

### Side and curtain air bags and front center air bag

Side and curtain air bags and front center air bag are designed to inflate when an impact is detected by side collision sensors depending on the severity of impact resulting from a side impact collision.

Although the driver's and front passenger's air bags are designed to inflate in frontal collisions, they also may inflate in other types of collisions if the front impact sensors detect a sufficient impact. Side and curtain air bags and front center air bag are designed to inflate in side impact collisions, but they may inflate in other collisions if the side impact sensors detect a sufficient impact.

Also, the side and curtain air bags and front center air bag are designed to inflate when a rollover is detected by a rollover sensor (if equipped with rollover sensor).

If the vehicle chassis is impacted by bumps or objects on unimproved roads, the air bags may deploy. Drive carefully on unimproved roads or on surfaces not designed for vehicle traffic to prevent unintended air bag deployment.

### Air bag non-inflation conditions



In certain low-speed collisions the air bags may not deploy. The air bags are designed not to deploy in such cases because they may not provide benefits beyond the protection of the seat belts.



Front air bags are not designed to inflate in rear collisions, because occupants are moved backward by the force of the impact. In this case, inflated air bags would not provide any additional benefit.

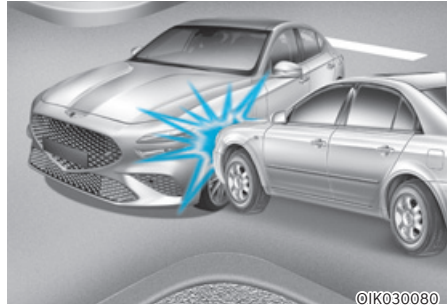

Front air bags may not inflate in side impact collisions, because occupants move in the direction of the collision, and thus in side impacts, front air bag deployment would not provide additional occupant protection.

However, side and curtain air bags and front center air bag may inflate depending on the severity of impact.

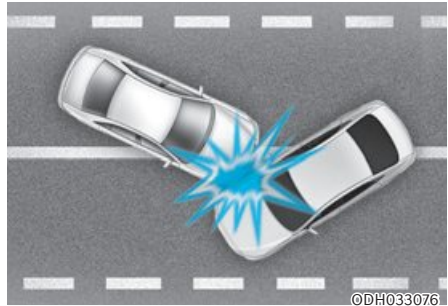

In an angled collision, the force of impact may direct the occupants in a direction where the air bags would not be able to provide any additional benefit, and thus the sensors may not deploy any air bags.

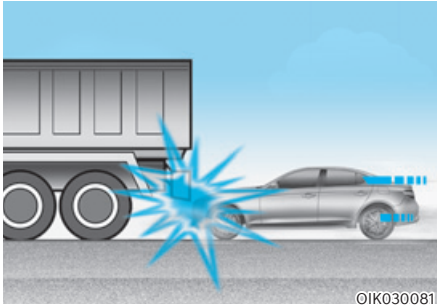

OIK030081

Just before impact, drivers often brake heavily. Such heavy braking lowers the front portion of the vehicle causing it to “ride” under a vehicle with a higher ground clearance. Air bags may not inflate in this “underride” situation because deceleration forces that are detected by sensors may be significantly reduced by such “underride” collisions.



OBH038062

Front air bags may not inflate in rollover accidents because front air bag deployment would not provide additional occupant protection.

## **i** Information

**With rollover sensor**

The side and curtain air bags and front center air bag may inflate in a rollover situation, when it is detected by the rollover sensor.

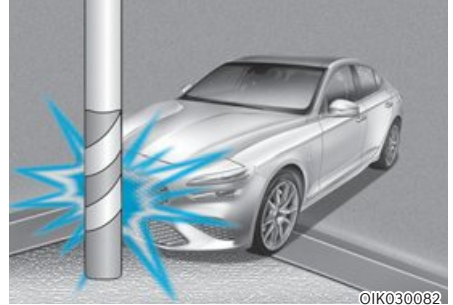

OIK030082

Air bags may not inflate if the vehicle collides with objects such as utility poles or trees, where the point of impact is concentrated and the collision energy is absorbed by the vehicle structure.

### SRS Care

The SRS is virtually maintenance-free and there are no parts you can safely service by yourself. If the SRS air bag warning light does not illuminate when the Engine Start/Stop button is in the ON position, or continuously remains on, have the system be immediately inspected by an authorized retailer of Genesis Branded products.

Any work on the SRS system, such as removing, installing, repairing, or any work on the steering wheel, the front passenger's panel, front seats and roof rails be performed by an authorized retailer of Genesis Branded products. Improper handling of the SRS system may result in serious personal injury.



### WARNING

**To reduce the risk of serious injury or death take the following precautions:**

- **Do not attempt to modify or disconnect the SRS components or wiring, including the addition of any kind of badges to the pad covers or modifications to the body structure.**
- **Do not place objects over or near the air bag modules on the steering wheel, instrument panel, and the front passenger's panel above the glove box.**
- **Clean the air bag pad covers with a soft cloth moistened with plain water. Solvents or cleaners could adversely affect the air bag covers and proper deployment of the system.**
- **Always have inflated air bags be replaced by an authorized retailer of Genesis Branded products.**
- **If components of the air bag system must be discarded, or if the vehicle must be scrapped, certain safety precautions must be observed. Consult with an authorized retailer of Genesis Branded products for the necessary information. Failure to follow these precautions could increase the risk of personal injury.**



## Additional Safety Precautions

**Passengers should not move out of or change seats while the vehicle is moving.** A passenger who is not wearing a seat belt during a crash or emergency stop can be thrown against the inside of the vehicle, against other occupants, or be ejected from the vehicle.

**Do not use any accessories on seat belts.** Devices claiming to improve occupant comfort or reposition the seat belt can reduce the protection provided by the seat belt and increase the chance of serious injury in a crash.

**Do not modify the front seats.** Modification of the front seats could interfere with the operation of the supplemental restraint system sensing components or side air bags.

**Do not place items under the front seats.** Placing items under the front seats could interfere with the operation of the supplemental restraint system sensing components and wiring harnesses.

**Do not cause impact to the doors.** Impact to the doors when the Engine Start/Stop button is in the ON or START position may cause the air bags to inflate.

**Modifications to accommodate disabilities.** If you require modification to your vehicle to accommodate a disability, contact Genesis Customer Care at 844 340-9741

### ***Adding equipment to or modifying your air bag equipped vehicle***

If you modify your vehicle by changing your vehicle's frame, bumper system, front end or side sheet metal or ride height, this may affect the operation of your vehicle's air bag system.

## Air Bag Warning Labels

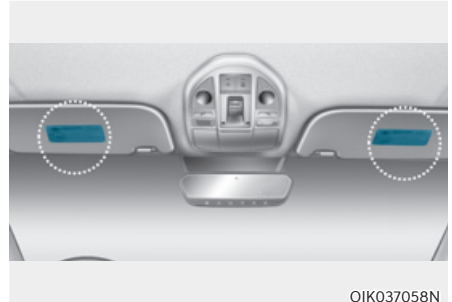

Air bag warning labels, required by the U.S. National Highway Traffic Safety Administration (NHTSA), are attached to alert the driver and passengers of potential risks of the air bag system. Be sure to read all of the information about the air bags that are installed on your vehicle in this Owners Manual.

# 4. Instrument Cluster

Instrument Cluster .....	4-4
Instrument Cluster Control.....	4-5
Instrument panel illumination.....	4-5
Gauges and Meters .....	4-6
Speedometer .....	4-6
Tachometer .....	4-6
Engine coolant temperature gauge.....	4-7
Fuel gauge.....	4-7
Outside temperature gauge.....	4-8
Odometer .....	4-8
Distance to empty .....	4-9
Transmission Shift Indicator .....	4-9
Automatic transmission shift indicator .....	4-9
Warning and Indicator Lights .....	4-10
Seat belt warning light .....	4-10
Air bag warning light .....	4-10
Parking brake & Brake fluid warning light.....	4-10
Anti-lock Brake System (ABS) warning light .....	4-11
Electronic Brake Force Distribution (EBD) system warning light .....	4-11
Electric Power Steering (EPS) warning light .....	4-12
Charging system warning light .....	4-12
Engine oil pressure warning light .....	4-13
Engine coolant temperature warning light (for 8-inch cluster).....	4-13
Low fuel level warning light .....	4-13
Malfunction Indicator Lamp (MIL).....	4-14
Master warning light.....	4-14
Electronic Parking Brake (EPB) warning light .....	4-15
Low tire pressure warning light .....	4-15
Forward Safety warning light .....	4-16
Lane Safety indicator light .....	4-16
All Wheel Drive (AWD) warning light .....	4-16
LED headlight warning light.....	4-17
Icy road warning light.....	4-17
Electronic Stability Control (ESC) indicator light.....	4-18
Electronic Stability Control (ESC) OFF indicator light.....	4-18
Immobilizer indicator light .....	4-18
Turn signal indicator light.....	4-19
High beam indicator light .....	4-19
Low beam indicator light .....	4-19
Light ON indicator light .....	4-19
High Beam Assist indicator light.....	4-19

- AUTO HOLD indicator light .....4-20
- SPORT mode indicator light.....4-20
- ECO mode indicator light.....4-20
- SPORT + mode indicator light.....4-21
- CUSTOM mode indicator light .....4-21
- LCD Display Messages.....4-21
  - Vehicle is on .....4-21
  - Shift to P .....4-21
  - Vehicle is in N. Press START button and shift to P .....4-21
  - Low key battery .....4-21
  - Press brake pedal to start engine .....4-22
  - Key not in vehicle .....4-22
  - Key not detected.....4-22
  - Press START button again .....4-22
  - Press START button with key.....4-22
  - Check BRAKE SWITCH fuse .....4-22
  - Shift to P or N to start engine.....4-22
  - Battery discharging due to external electrical devices.....4-23
  - Door, Hood, trunk open indicator.....4-23
  - Sunroof open indicator.....4-23
  - Low tire pressure .....4-23
  - Lights .....4-24
  - Wiper .....4-24
  - Low washer fluid.....4-25
  - Low fuel .....4-25
  - Low engine oil .....4-25
  - Engine overheated.....4-25
  - Check haptic steering wheel system.....4-25
  - Check headlight .....4-25
  - Check turn signal .....4-25
  - Check headlamp LED .....4-25

# 4. Instrument Cluster

LCD Display .....	4-26
LCD Display Control .....	4-26
View Modes .....	4-26
Driving Assist view .....	4-27
Turn By Turn (TBT) view .....	4-27
Utility view .....	4-27
Option Menu .....	4-30
Service messages .....	4-31
Head-up display .....	4-31
Driver Assistance settings .....	4-31
Speed unit .....	4-31
Vehicle Settings (Infotainment System) .....	4-32
Setting Your Vehicle .....	4-32

## INSTRUMENT CLUSTER



- |                |                                     |
|----------------|-------------------------------------|
| 1. Tachometer  | 4. Engine coolant temperature gauge |
| 2. Speedometer | 5. Warning and indicator lights     |
| 3. Fuel gauge  | 6. LCD display                      |

## Instrument Cluster Control

### Instrument panel illumination (if equipped)

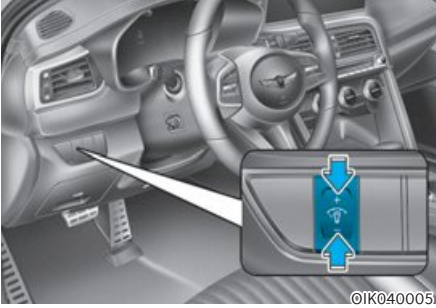

When the vehicle's position lights or headlamps are on, press the illumination control switch to adjust the brightness of the instrument panel illumination.

When pressing the illumination control switch, the interior switch illumination intensity is also adjusted.



### **WARNING**

**Never adjust the instrument cluster while driving. This could result in loss of control and lead to an accident that may cause death, serious injury, or vehicle damage.**

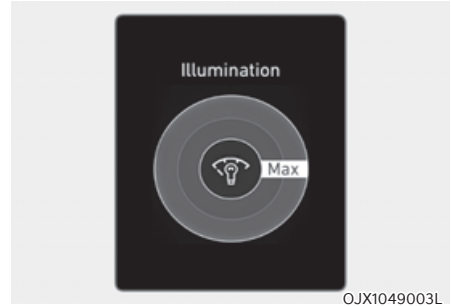

- The brightness of the instrument panel illumination is displayed.
- If the brightness reaches to the maximum or minimum level, a chime will sound.

## Gauges and Meters

### Speedometer



The speedometer indicates the speed of the vehicle and is calibrated in miles per hour (MPH) and/or kilometers per hour (km/h).

### Tachometer



The tachometer indicates the approximate number of engine revolutions per minute (RPM).

Use the tachometer to select the correct shift points and to prevent lugging and/or over-revving the engine.

### **NOTICE**

**Do not operate the engine within the tachometer's RED ZONE. This may cause severe engine damage.**

### Engine coolant temperature gauge

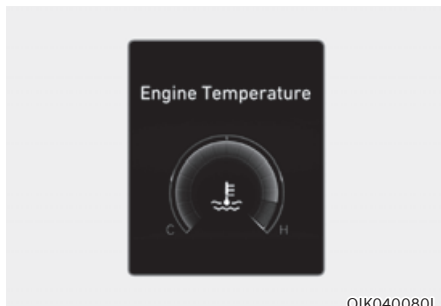

This gauge indicates the temperature of the engine coolant when the Engine Start/Stop button is in the ON position. You can check the engine coolant temperature in the Utility view on the cluster.

Refer to “View Modes” section in chapter 4.

#### NOTICE

If the gauge pointer moves beyond the normal range area toward the “H (Hot)” position, it indicates overheating that may damage the engine.

Do not continue driving with an overheated engine. If your vehicle overheats, refer to “If the Engine Overheats” section in chapter 8.



#### WARNING

Never remove the engine coolant reservoir cap when the engine is hot.

The engine coolant is under pressure and could cause severe burn. Wait until the engine is cool before adding coolant to the reservoir.

### Fuel gauge



This gauge indicates the approximate amount of fuel remaining in the fuel tank.



#### Information

- The fuel tank capacity is given in chapter 2.
- The fuel gauge is supplemented by a low fuel warning light, which will illuminate when the fuel tank is nearly empty.
- On inclines or curves, the fuel gauge pointer may fluctuate or the low fuel warning light may come on earlier than usual due to the movement of fuel in the tank.



#### WARNING

Running out of fuel can expose vehicle occupants to danger.

You must stop and obtain additional fuel as soon as possible after the warning light comes on or when the gauge indicator comes close to the “E (Empty)” level.

#### NOTICE

Avoid driving with an extremely low fuel level. Running out of fuel could cause the engine to misfire damaging the catalytic converter.



### Outside temperature gauge

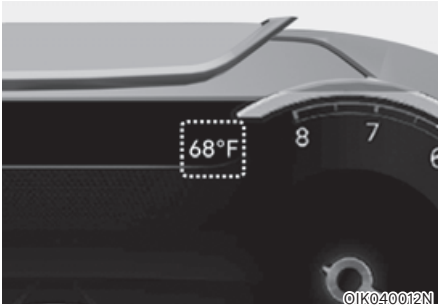

This gauge indicates the current outside air temperatures by 1°F (1°C).

Note that the temperature indicated on the LCD display may not change as quickly as the outside temperature (there may be a slight delay before the temperature changes.)

You can change the temperature unit from the Settings menu in the infotainment system screen. Select:

- Setup → General Settings → Unit → Temperature Unit → °C/°F

### See additional information in supplied Infotainment Manual.

For vehicles equipped with Automatic Climate Control, you can also:

- Press the AUTO button while pressing the OFF button on the climate control unit for 3 seconds

Both the temperature unit on the cluster LCD display and climate control screen will change.

### Odometer

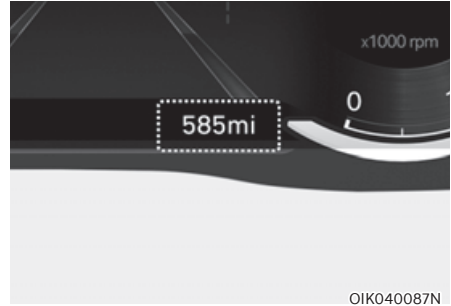

The odometer indicates the total distance that the vehicle has been driven and should be used to determine when periodic maintenance should be performed.

### Distance to empty



- The distance to empty is the estimated distance the vehicle can be driven with the remaining fuel.
- If the estimated distance is below 1 mi. (1 km), the trip computer will display "----" as range.

### **i** Information

- If the vehicle is not on level ground or the battery power has been interrupted, the distance to empty function may not operate correctly.
- The distance to empty may differ from the actual driving distance as it is an estimate of the available driving distance.
- The trip computer may not register additional fuel if less than 1.6 gallon (6 liters) of fuel are added to the vehicle.
- The distance to empty may vary significantly based on driving conditions, driving habits, and condition of the vehicle.

### Transmission Shift Indicator

#### Automatic transmission shift indicator



This indicator informs the current gear engaged.

## Warning and Indicator Lights

### **i** Information

Make sure that all warning lights are OFF after starting the engine. If any light is still ON, this indicates a situation that needs attention.

#### **Seat belt warning light**



This warning light informs the driver that the seat belt is not fastened.

For more details, refer to “Seat Belts” section in chapter 3.

#### **Air bag warning light**



This warning light illuminates:

- When you set the Engine Start/Stop button to the ON position.
  - The air bag warning light illuminates for about 6 seconds and then turns off when all checks have been performed.
- The air bag warning light will remain illuminated if there is a malfunction with the Safety Restraint System (SRS) air bag operation.

If this occurs, have the vehicle inspected by an authorized retailer of Genesis Branded products.

#### **Parking brake & Brake fluid warning light**



This warning light illuminates:

- When you set the Engine Start/Stop button to the ON position.
  - The parking brake & brake fluid warning light illuminates for about 3 seconds and will then turn off once the parking brake is released.
- Whenever the parking brake is applied.
- Whenever the brake fluid level in the reservoir is low.
  - If the warning light illuminates with the parking brake released, it indicates the brake fluid level in the reservoir is low.

If the brake fluid level in the reservoir is low:

1. Drive carefully to the nearest safe location and stop your vehicle.
2. With the engine stopped, check the brake fluid level immediately and add fluid as required (**For more details, refer to “Brake Fluid” section in chapter 9**). After adding brake fluid, check all brake components for fluid leaks. If a brake fluid leak is found, or if the warning light remains on, or if the brakes do not operate properly, do not drive the vehicle. Have the vehicle inspected by an authorized retailer of Genesis Branded products.

### Dual-diagonal braking system

Your vehicle is equipped with dual-diagonal braking system. This means you still have braking on two wheels even if one of the dual systems should fail.

With only one of the dual systems working, more than normal pedal travel and greater pedal pressure is required to stop the vehicle.

Also, the vehicle will not stop in as short a distance with only a portion of the brake system working.

If the brakes fail while you are driving, shift to a lower gear for additional engine braking and stop the vehicle as soon as it is safe to do so.



### WARNING

**Parking Brake & Brake Fluid warning light**

**Driving the vehicle with a warning light ON is dangerous. If the Parking Brake & Brake Fluid warning light illuminates with the parking brake released, it indicates that the brake fluid level is low.**

**If this occurs, Have the vehicle inspected by an authorized retailer of Genesis Branded products.**

### Anti-lock Brake System (ABS) warning light



**This warning light illuminates:**

- When you set the Engine Start/Stop button to the ON position.
  - The ABS warning light illuminates for about 3 seconds and then goes off.
- Whenever there is a malfunction with the ABS.

Note that the hydraulic braking system will still be operational even if there is a malfunction with the ABS.

If this occurs, have the vehicle inspected by an authorized retailer of Genesis Branded products.

### Electronic Brake Force Distribution (EBD) system warning light



When the ABS warning and Parking Brake warning lights are on simultaneously, it may indicate a problem with the Electronic Brake Force Distribution system.

If this occurs, have the vehicle inspected by an authorized retailer of Genesis Branded products.



## WARNING

Electronic Brake Force Distribution (EBD) system warning light

When both ABS and Parking Brake & Brake Fluid warning lights are on, the brake system will not work normally and you may experience an unexpected and dangerous situation during sudden braking.

If this occurs, avoid high speed driving and abrupt braking.

Have the vehicle inspected by an authorized retailer of Genesis Branded products as soon as possible.

## NOTICE

Electronic Brake Force Distribution (EBD) system warning light

When the ABS warning light is on or both ABS and Parking Brake & Brake Fluid warning lights are on, the speedometer, odometer, or tripmeter may not work. Also, the EPS warning light may illuminate and the steering effort may increase or decrease.

If this occurs, have the vehicle inspected by an authorized retailer of Genesis Branded products as soon as possible.

## Electric Power Steering (EPS) warning light



This warning light illuminates:

- When you set the Engine Start/Stop button to the ON position.
  - The electric powering steering warning light illuminates for about 3 seconds and then goes off.
- Whenever there is a malfunction with the electric power steering.  
If this occurs, have the vehicle inspected by an authorized retailer of Genesis Branded products.

## Charging system warning light



This warning light illuminates:

When there is a malfunction with either the alternator or electrical charging system.

If there is a malfunction with either the alternator or electrical charging system:

1. Drive carefully to the nearest safe location and stop your vehicle.
2. Turn the engine off and check the alternator drive belt for looseness or breakage.

If the belt is adjusted properly, there may be a problem in the electrical charging system.

If this occurs, have the vehicle inspected by an authorized retailer of Genesis Branded products as soon as possible.

### Engine oil pressure warning light



If the engine oil pressure is low:

- Drive carefully to the nearest safe location and stop your vehicle.
- Turn the engine off and check the engine oil level (For more details, refer to “Engine Oil” section in chapter 9). If the level is low, add oil as required.

If the warning light remains on after adding oil or if oil is not available, have the vehicle inspected by an authorized retailer of Genesis Branded products. (Continued driving with the warning light on may cause engine failure.)

#### NOTICE

- **If the engine is not stopped immediately after the Engine Oil Pressure warning light is illuminated while the engine is running, severe damage could result.**
- **If the warning light stays on while the engine is running, it indicates that there may be serious engine damage or malfunction. In this case:**
  1. **Stop the vehicle as soon as it is safe to do so.**
  2. **Turn off the engine and check the oil level. If the oil level is low, fill the engine oil to the proper level.**
  3. **Start the engine again. If the warning light stays on after the engine is started, turn the engine off immediately. If this occurs, have the vehicle inspected by an authorized retailer of Genesis Branded products.**

### Engine coolant temperature warning light (for 8-inch cluster)



The warning light illuminates:

When the temperature of the engine coolant is extremely high.

Do not continue driving with an overheated engine. If your vehicle overheats, refer to “Overheating” section in chapter 8.

#### NOTICE

**If the Engine Coolant Temperature warning light illuminates, it indicates overheating that may damage the engine.**

### Low fuel level warning light



This warning light illuminates:

When the fuel tank is nearly empty. Add fuel as soon as possible.

#### NOTICE

**Driving with the Low Fuel Level warning light on or with the fuel level below “E” can cause the engine to misfire and damage the catalytic converter.**

### **Malfunction Indicator Lamp (MIL)**



**This indicator light illuminates:**

- When you set the Engine Start/Stop button to the ON position.
  - The malfunction indicator light illuminates for about 3 seconds and then goes off.
- Whenever there is a malfunction with either the emission control system or the engine or the vehicle powertrain.

If this occurs, have the vehicle inspected by an authorized retailer of Genesis Branded products.

#### **NOTICE**

**Driving with the Malfunction Indicator Lamp (MIL) on may cause damage to the emission control system which could affect drivability and/or fuel economy.**

#### **NOTICE**

**If the Malfunction Indicator Lamp (MIL) illuminates, potential catalytic converter damage is possible which could result in loss of engine power. If this occurs, have the vehicle inspected by an authorized retailer of Genesis Branded products as soon as possible.**

### **Master warning light**



**This warning light illuminates:**

When there is a malfunction in operation in any of the following systems:

- Forward Collision-Avoidance Assist malfunction (if equipped)
- Forward Collision-Avoidance Assist radar blocked (if equipped)
- Blind-Spot Collision Warning malfunction (if equipped)
- Blind-Spot Collision Warning radar blocked (if equipped)
- LED headlamp malfunction (if equipped)
- High Beam Assist malfunction (if equipped)
- Smart Cruise Control with malfunction (if equipped)
- Smart Cruise Control with radar blocked (if equipped)
- Tire Pressure Monitoring System (TPMS) malfunction

To identify the details of the warning, look at the LCD display.

### **Electronic Parking Brake (EPB) warning light (if equipped)**

## EPB

This warning light illuminates:

- When you set the Engine Start/Stop button to the ON position.
  - The EPB warning light illuminates for about 3 seconds and then goes off.
- Whenever there is a malfunction with EPB.
 

If this occurs, have the vehicle inspected by an authorized retailer of Genesis Branded products.



### Information

The Electronic Parking Brake (EPB) warning light may illuminate when the Electronic Stability Control (ESC) indicator light comes on to indicate that ESC is not working properly. This does not indicate malfunction of EPB.

### **Low tire pressure warning light**



This warning light illuminates:

- When you set the Engine Start/Stop button to the ON position.
  - The low tire pressure warning light illuminates for approximately 3 seconds and then goes off.
- When one or more of your tires are significantly underinflated. (The location of the underinflated tires are displayed on the LCD display.)

**For more details, refer to “Tire Pressure Monitoring System (TPMS)” section in chapter 8.**

This warning light remains ON after blinking for approximately 60 seconds, or repeatedly blinks ON and OFF in 3 second intervals:

When there is a malfunction with the TPMS.

If this occurs, have the vehicle inspected by an authorized retailer of Genesis Branded products as soon as possible.

**For more details, refer to “Tire Pressure Monitoring System (TPMS)” section in chapter 8.**



### WARNING

#### Safe Stopping

- The TPMS cannot alert you to severe and sudden tire damage caused by external factors.
- If you notice any vehicle instability, immediately take your foot off the accelerator pedal, apply the brakes gradually with light force, and slowly move to a safe position off the road.



**Forward Safety warning light  
(if equipped)**



**This warning light illuminates:**

- When you set the Engine Start/Stop button to the ON position.
  - The Forward Safety warning light illuminates for approximately 3 seconds and then goes off.
- Whenever there is a malfunction with Forward Collision-Avoidance Assist.

If this occurs, have the vehicle inspected by an authorized retailer of Genesis Branded products.

**For more details, refer to “Forward Collision-Avoidance Assist (FCA)” section in chapter 7.**

**Lane Safety indicator light  
(if equipped)**



**This indicator light illuminates:**

- [Green] When the system operating conditions are satisfied.
- [White] When the system operating conditions are not satisfied.
- [Yellow] Whenever there is a malfunction with Lane Keeping Assist.  
If this occurs, have the vehicle inspected by an authorized retailer of Genesis Branded products.

**For more details, refer to “Lane Keeping Assist (LKA)” section in chapter 7.**

**All Wheel Drive (AWD)  
warning light (if equipped)**



**This warning light illuminates:**

Whenever there is a malfunction with the AWD system.

If this occurs, have the vehicle inspected by an authorized retailer of Genesis Branded products.

**For more details, refer to "All Wheel Drive (AWD)" section in chapter 6.**

### **LED headlight warning light (if equipped)**



**This warning light illuminates:**

- When you set the Engine Start/Stop button to the ON position.
  - The LED headlight warning light illuminates for approximately 3 seconds and then goes off.
- Whenever there is a malfunction with the LED headlight.

If this occurs, have the vehicle inspected by an authorized retailer of Genesis Branded products.

**This warning light blinks:**

Whenever there is a malfunction with a LED headlight related part.

If this occurs, have the vehicle inspected by an authorized retailer of Genesis Branded products.

#### **NOTICE**

**Continuous driving with the LED Headlight warning light on or blinking can reduce LED headlight life.**

### **Icy road warning light (if equipped)**



This warning light is to warn the driver the road may be icy.

When the temperature on the outside temperature gauge is approximately below 40°F (4°C), the Icy Road warning light and Outside Temperature Gauge blinks and then illuminates. Also, the warning chime sounds 1 time.

You can activate or deactivate Icy Road Warning function from the Settings menu in the infotainment system screen. Select:

- Setup → Vehicle Settings → Cluster → Content Selection → Icy Road Warning

**See additional information in supplied Infotainment Manual.**

#### **Information**

**If the Icy Road warning light appears while driving, you should drive more attentively and safely refraining from over-speeding, rapid acceleration, sudden braking or sharp turning, etc.**

**Electronic Stability Control (ESC) indicator light (if equipped)**



This indicator light illuminates:

- When you set the Engine Start/Stop button to the ON position.
  - The Electronic Stability Control indicator light illuminates for about 3 seconds and then goes off.
- Whenever there is a malfunction with ESC system.

If this occurs, have the vehicle inspected by an authorized retailer of Genesis Branded products.

**This indicator light blinks:**

While ESC is operating.

**For more details, refer to “Electronic Stability Control (ESC)” section in chapter 6.**

**Electronic Stability Control (ESC) OFF indicator light (if equipped)**



This indicator light illuminates:

- When you set the Engine Start/Stop button to the ON position.
  - The ESC OFF indicator light illuminates for approximately 3 seconds and then goes off.
- When you deactivate ESC system by pressing the ESC OFF button.

**For more details, refer to “Electronic Stability Control (ESC)” section in chapter 6.**

**Immobilizer indicator light**



This indicator light illuminates for up to 30 seconds:

When the vehicle detects the smart key in the vehicle with the Engine Start/Stop button in the ACC or ON position.

- Once the smart key is detected, you can start the engine.
- The indicator light goes off after starting the engine.

**This indicator light blinks for a few seconds:**

When the smart key is not in the vehicle.

- If the smart key is not detected, you cannot start the engine.

**This indicator light illuminates for 2 seconds and goes off:**

If the smart key is in the vehicle and the Engine Start/Stop button is ON, but the vehicle cannot detect the smart key.

If this occurs, have the vehicle inspected by an authorized retailer of Genesis Branded products.

**This indicator light blinks:**

Whenever there is a malfunction with the immobilizer system.

If this occurs, have the vehicle inspected by an authorized retailer of Genesis Branded products.

**Turn signal indicator light****This indicator light blinks:**

When you operate the turn signal indicator stalk.

If any of the following occur, there may be a malfunction with the turn signal system.

- The turn signal indicator light illuminates but does not blink
- The turn signal indicator light blinks rapidly
- The turn signal indicator light does not illuminate at all

If any of these conditions occur, have the vehicle inspected by an authorized retailer of Genesis Branded products.

**High beam indicator light****This indicator light illuminates:**

- When the headlamps are on and in the high beam position
- When the turn signal lever is pulled into the Flash-to-Pass position.

**Low beam indicator light****This indicator light illuminates:**

When the headlamps are on.

**Light ON indicator light****This indicator light illuminates:**

When the position lamps or headlamps are on.

**High Beam Assist indicator light****This indicator light illuminates:**

When the high-beam is on with the light switch in the AUTO position.

If your vehicle detects oncoming or preceding vehicles, High Beam Assist will switch the high beam to low beam automatically.

**For more details, refer to “High Beam Assist (HBA)” section in chapter 5.**

***AUTO HOLD indicator light  
(if equipped)***



**This indicator light illuminates:**

- [White] When you activate Auto Hold by pressing the AUTO HOLD switch.
- [Green] When you stop the vehicle completely by depressing the brake pedal with Auto Hold activated.
- [Yellow] Whenever there is a malfunction with the Auto Hold function.

If this occurs, have the vehicle inspected by an authorized retailer of Genesis Branded products.

**For more details, refer to “Electronic Parking Brake (EPB)” section in chapter 6.**

***SPORT mode indicator light  
(if equipped)***



**This indicator light illuminates**

When you select SPORT mode as drive mode.

**For more details, refer to "Drive Mode Integrated Control System" in chapter 6.**

***ECO mode indicator light  
(if equipped)***



**This indicator light illuminates**

When you select ECO mode as drive mode.

**For more details, refer to "Drive Mode Integrated Control System" in chapter 6.**

***SPORT + mode indicator light (if equipped)***

SPORT+

This indicator light illuminates

When you select SPORT+ mode as drive mode.

For more details, refer to "Drive Mode Integrated Control System" in chapter 6.

***CUSTOM mode indicator light (if equipped)***

CUSTOM

This indicator light illuminates

When you select CUSTOM mode as drive mode.

For more details, refer to "Drive Mode Integrated Control System" in chapter 6.

**LCD Display Messages*****Vehicle is on***

This message is displayed if you open the driver's door when the gear is in P (Park) and the Engine Start/Stop button in the ON or START position.

Turn the engine off before leaving the vehicle.

***Shift to P***

This message is displayed if you try to turn off the vehicle without the gear in the P (Park) position.

If this occurs, the Engine Start/Stop button turns to the ACC position.

***Vehicle is in N. Press START button and shift to P***

This message is displayed if you try to turn off the vehicle with the gear in N (Neutral).

To turn off the vehicle:

1. Press the Engine Start/Stop button. The button will change to the ON position.
2. Press the P button to shift to P (Park).
3. Press the Engine Start/Stop button again, then the vehicle will turn off.

***Low key battery***

This message is displayed if the battery of the smart key is discharged while changing the Engine Start/Stop button to the OFF position.

**Press brake pedal to start engine**

This message is displayed if the Engine Start/Stop button changes to the ACC position twice by pressing the button repeatedly without depressing the brake pedal.

You can start the vehicle by depressing the brake pedal and then pressing the Engine Start/Stop button.

**Key not in vehicle**

This message is displayed if the smart key is not in the vehicle when you leave the vehicle with the Engine Start/Stop button in the ON or Start position.

Always turn off the engine before leaving your vehicle.

**Key not detected**

This message is displayed if the smart key is not detected when you press the Engine Start/Stop button.

**Press START button again**

This message is displayed if you were unable to start the vehicle when the Engine Start/Stop button was pressed.

If this occurs, attempt to start the engine by pressing the Engine Start/ Stop button again.

If the warning message appears each time you press the Engine Start/Stop button, we recommend that you have the vehicle inspected by an authorized retailer of Genesis Branded products.

**Press START button with key**

This warning message is displayed if you press the Engine Start/Stop button while the warning message "Key not detected" is displayed.

At this time, the immobilizer indicator light blinks.

**Check BRAKE SWITCH fuse**

This message is displayed if the brake switch fuse is disconnected.

You need to replace the fuse with a new one before starting the engine.

If that is not possible, you can start the engine by pressing the Engine Start/ Stop button for 10 seconds in the ACC position.

**Shift to P or N to start engine**

This message is displayed if you try to start the engine in any other position except P (Park) or N (Neutral).

** Information**

**You can start the engine with the gear in N (Neutral). But, for your safety, we recommend that you start the engine with the gear shifted to P (Park).**

### **Battery discharging due to external electrical devices**

This message is displayed if the 12V battery voltage is weak due to any non-factory electrical accessories (ex. dashboard camera) while parking. Be careful that the battery is not discharged.

If the message appears after removing the non-factory electrical accessories, have the vehicle inspected by an authorized retailer of Genesis Branded products.

### **Door, Hood, trunk open indicator**

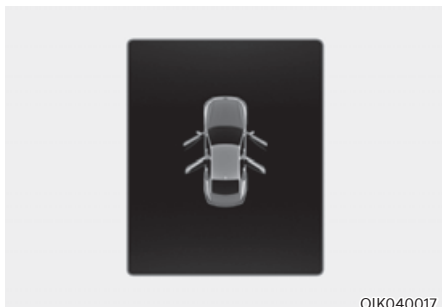

This warning is displayed if any door or hood or trunk is left open. The warning will indicate which door is open in the display.



### **CAUTION**

**Before driving the vehicle, you should confirm that the door/ hood/trunk is fully closed.**

### **Sunroof open indicator (if equipped)**

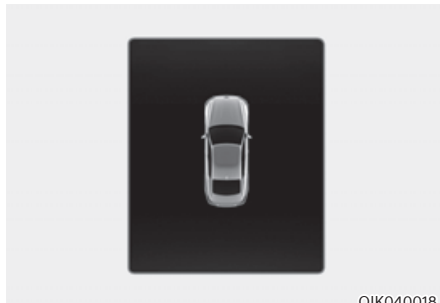

This warning is displayed if you turn off the engine when the sunroof is open.

Close the sunroof securely before leaving your vehicle.

### **Low tire pressure**



This warning message is displayed if the tire pressure is low. The corresponding tire on the vehicle will be illuminated.

**For more details, refer to “Tire Pressure Monitoring System (TPMS)” section in chapter 8.**



### Lights

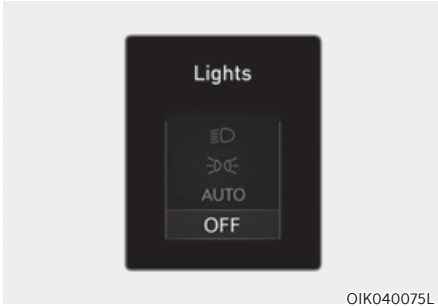

This indicator displays which exterior light is selected using the lighting control.

You can activate or deactivate Wiper/Lights display function from the Settings menu in the infotainment system screen. Select:

- Setup → Vehicle Settings → Cluster → Content Selection → Wiper/Lights Display

**See additional information in supplied Infotainment Manual.**

### Wiper



This indicator displays which wiper speed is selected using the wiper control.

You can activate or deactivate Wiper/Lights display function from the Settings menu in the infotainment system screen. Select:

- Setup → Vehicle Settings → Cluster → Content Selection → Wiper/Lights Display

**See additional information in supplied Infotainment Manual.**

**Low washer fluid**

This message is displayed if the washer fluid level in the reservoir is nearly empty. Have the washer fluid reservoir refilled.

**Low fuel**

This message is displayed if the fuel tank is almost out of fuel.

When this message is displayed, the low fuel level warning light in the cluster will come on.

It is recommended to look for the nearest fueling station and refuel as soon as possible.

**Low engine oil (if equipped)**

This warning message is displayed when the engine oil level should be checked.

If this warning message is displayed, check the engine oil level as soon as possible and add engine oil as required.

Slowly pour the recommended oil little by little into a funnel.

Use only the specified engine oil. (Refer to "Recommended Lubricants and Capacities" section in chapter 2.)

Do not overfill the engine oil. Make sure the oil level is not above F (Full) mark on the dipstick.

**Information**

**After adding engine oil, if you travel approximately 31~62 miles (50~100 km) after the engine warms up, the warning message should disappear.**

**Engine overheated**

This message is displayed when the engine coolant temperature is above 248°F (120°C). This means that the engine is overheated and may be damaged.

**If your vehicle is overheated, refer to "Overheating" section in chapter 8.**

**Check haptic steering wheel system**

This message is displayed if there is a problem with the haptic steering wheel system. Have the vehicle inspected by an authorized retailer of Genesis Branded products.

**Check headlight (if equipped)**

This message is displayed if the headlights are not operating properly. A lamp may need to be replaced.

Make sure to replace the burned out bulb with a new one of the same wattage rating.

**Check turn signal (if equipped)**

This message is displayed if the turn signal lamps are not operating properly. A lamp may need to be replaced.

Make sure to replace the burned out bulb with a new one of the same wattage rating.

**Check headlamp LED (if equipped)**

This message is displayed if there is a problem with the LED headlamp. Have the vehicle inspected by an authorized retailer of Genesis Branded products.

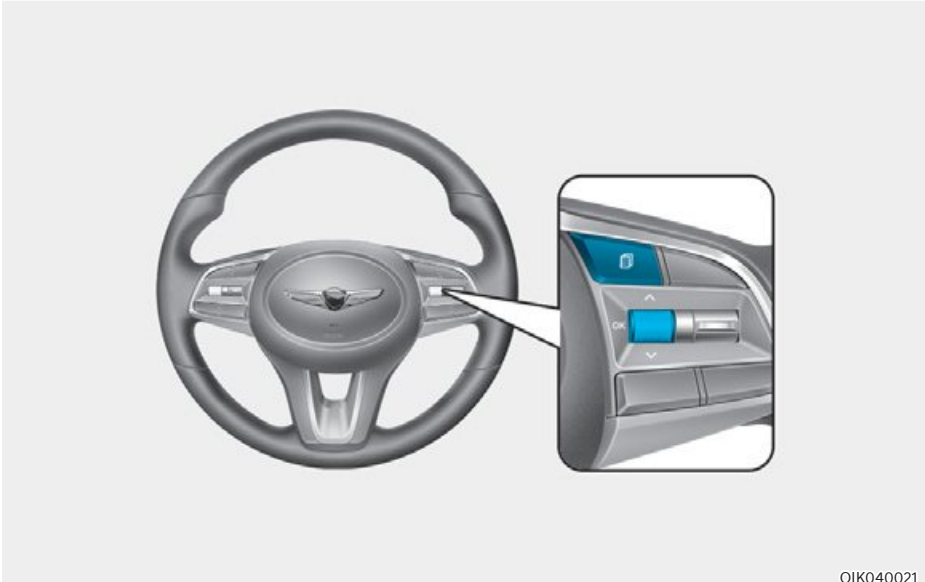

## LCD DISPLAY

### LCD Display Control



OIK040021

The LCD display modes can be changed by using the control switches.

Switch	Operation	Function
	Press	MODE button for changing View modes
	Scroll	UP, DOWN switch for changing items in Utility view and Option menu
OK	Press	SELECT/RESET switch for entering Option menu
	Press and hold	SELECT/RESET switch for retrieving assist information or resetting the selected item

### View Modes

View modes	Explanation
Driving Assist	Driving Assist view displays the status of the vehicle's Driver Assistance systems.
Turn by Turn	Turn By Turn view displays the state of the navigation.
Utility	Utility view displays driving information such as the trip distance, fuel economy and etc.

**The information provided may differ depending on which functions are applicable to your vehicle.**

### Driving Assist view



OIK040040N

The status of Smart Cruise Control, Lane Following Assist, Highway Driving Assist, etc. is displayed when Driving Assist view is selected.

**For more details, refer to each system information section in chapter 7.**

### Turn By Turn (TBT) view



OIK040085L

Turn-by-turn navigation, distance/time to destination information is displayed when Turn by Turn view is selected.

### Utility view

In the Utility view, using the  $\wedge$ ,  $\vee$  (Up, Down) switch, you may change through items in the following order.



OIK040072N

### Gauges

This mode displays information related to your engine such as engine oil temperature (1), current torque (2) and turbo boost pressure (3).

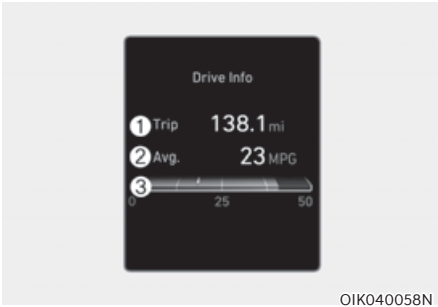

OIK040058N

### Drive info

Trip distance (1), average fuel economy (2), and instant fuel economy (3) are displayed.

The information is combined for each ignition cycle. However, when the engine has been OFF for 4 hours or longer the Drive Info screen will reset.

To reset manually, press the OK switch on the steering wheel for more than 1 second when 'Drive Info' is displayed.



OIK040062N

### Accumulated info

Accumulated trip distance (1), average fuel economy (2), and instant fuel economy (3) are displayed.

The information is accumulated starting from the last reset.

To reset manually, press the OK switch on the steering wheel for more than 1 second when 'Accumulated Info' is displayed.

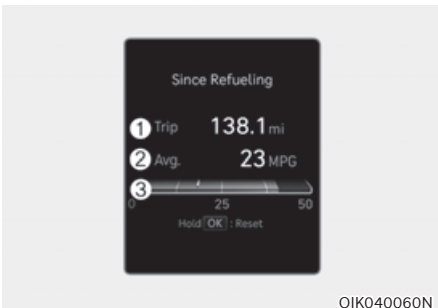

OIK040060N

### Since refueling

Trip distance (1), average fuel economy (2), and instant fuel economy (3) after the vehicle has been refueled are displayed.

To reset manually, press the OK switch on the steering wheel for more than 1 second when 'Since Refueling' is displayed.

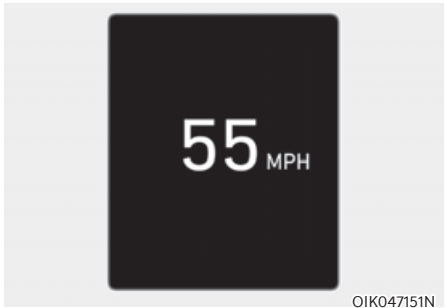

OIK047151N

### Digital speedometer

Digital speedometer display shows the speed of the vehicle.



OIK040086L

### Attention level

The driver's attention level is shown based on the driver's driving pattern.

**For more details, refer to "Driver Attention Warning (DAW)" section in chapter 7.**



OIK080023L

### Tire pressure

The tire pressure of each tire is displayed.

**For more details, refer to "Tire Pressure Monitoring System (TPMS)" section in chapter 8.**

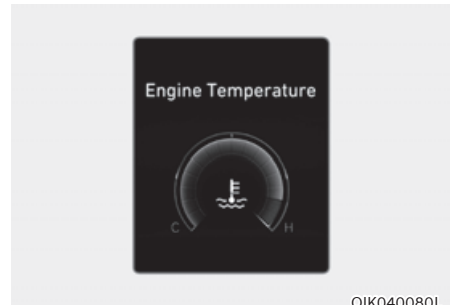

OIK040080L

### Engine temperature

Engine coolant temperature gauge display shows the temperature of the engine coolant when the engine is running.

Select contents

You can select the items to be displayed in Utility view.

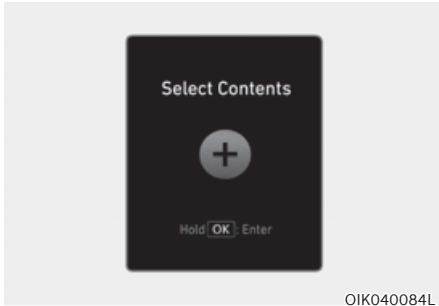

1. Press and hold the OK switch on the steering wheel.
2. Use the ^, v (Up, Down) switch to change items, and press the OK switch to select or deselect the item.
3. After selecting the items to be displayed in the Utility view, press the [MODE] button to exit the 'Select Contents' display.

 **WARNING**

To avoid driver distractions, do not adjust the setting while driving the vehicle which may lead to an accident.

Option Menu

Press the OK switch to enter Option menu.

 **WARNING**

To avoid driver distractions, do not adjust the setting while driving which may lead to an accident.

 **Information**

The information provided may differ depending on which functions are applicable to your vehicle.

Menu	Explanation
Service messages	To check vehicle warning messages.
Head-up display	To activate or deactivate head-up display.
Driver Assistance settings	To directly display "Driver Assistance" menu on the infotainment system screen
Speed unit	To set speed unit between km/h and MPH.

### **Service messages**

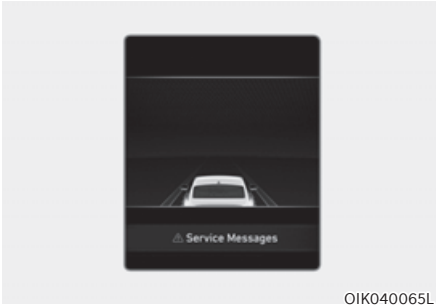

When Service Messages menu is selected, press the OK switch on the steering wheel to check vehicle warning messages.

### **Head-up display (if equipped)**



When Head-Up Display menu is selected, press the OK switch on the steering wheel. You may select or deselect head-up display by pressing the OK switch.

### **Driver Assistance settings**



When Driver Assistance Settings menu is selected, press the OK switch on the steering wheel. The 'Driver Assistance' menu will be displayed on the infotainment system screen.

### **Speed unit (if equipped)**

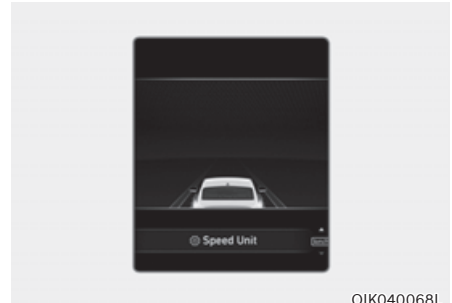

When the Speed Unit menu is selected, press the OK switch on the steering wheel. You can change the speed unit setting between km/h and MPH for the cluster.



## VEHICLE SETTINGS (INFOTAINMENT SYSTEM)



©IK040027L

Vehicle Settings in the infotainment system provides user options for a variety of settings including door lock/unlock features, convenience features, driver assistance settings, etc.

### Vehicle Settings menu

- Drive Assistance
- Drive Mode
- Head-Up Display
- Cluster
- Climate
- Seat
- Light
- Door
- Digital Key
- Convenience

The information provided may differ depending on which functions are applicable to your vehicle.



### WARNING

**Do not operate the Vehicle Settings while driving. This may cause distraction resulting in an accident.**

### Setting Your Vehicle

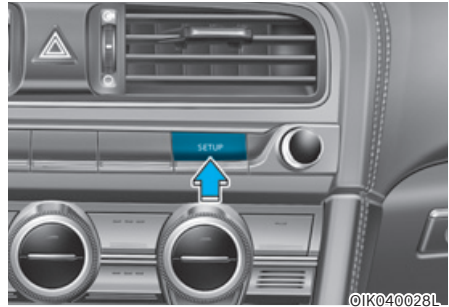

©IK040028L

1. Press the SETUP button on the head unit of the infotainment system.

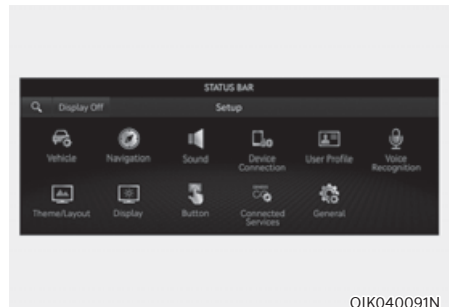

OIK040091N

2. Select 'Vehicle' and change the setting of the features.

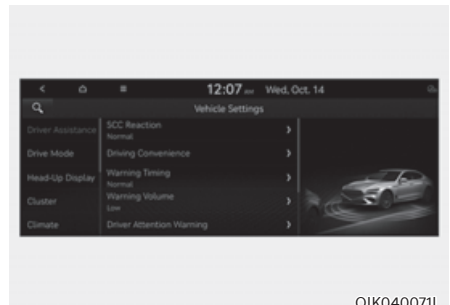

OIK040071L

**See additional information in supplied Infotainment Manual.**

# 5. Convenient Features

Accessing Your Vehicle.....	5-4
Smart Key.....	5-4
Immobilizer System .....	5-12
Genesis Digital Key .....	5-13
Digital Key (Smart Phone).....	5-13
Digital Key (Card Key).....	5-19
Personalized Profile and Vehicle Settings .....	5-22
Used Vehicle/Digital Key Maintenance .....	5-25
Limitations of the System .....	5-25
Door Lock .....	5-26
Operating Door Locks from Outside the Vehicle .....	5-26
Operating Door Locks from Inside the Vehicle .....	5-27
Automatic Door Lock and Unlock Features.....	5-30
Child-Protector Rear Door Locks .....	5-30
Theft-Alarm System .....	5-31
Integrated Memory System.....	5-32
Storing Memory Positions .....	5-32
Recalling Memory Positions .....	5-33
Resetting the System .....	5-33
Seat Easy Access .....	5-34
Steering Wheel.....	5-35
Electric Power Steering (EPS).....	5-35
Tilt/Telescopic Steering .....	5-36
Horn.....	5-37
Heated Steering Wheel.....	5-38
Mirrors .....	5-39
Inside Rearview Mirror .....	5-39
Side View Mirrors .....	5-49
Reverse Parking Aid .....	5-51
Windows.....	5-53
Power Windows.....	5-54
Remote Window Opening Function .....	5-57
Wide sunroof .....	5-58
Power sunblind.....	5-59
Tilt open/close.....	5-59
Slide open/close.....	5-60
Sunroof Open Warning .....	5-62

Exterior Features.....	5-63
Hood.....	5-63
Trunk.....	5-64
Smart Trunk .....	5-66
Fuel Filler Door .....	5-68
Head-Up Display (HUD).....	5-71
Head-Up Display Settings .....	5-71
Head-Up Display Information .....	5-71
Precautions While Using the Head-Up Display.....	5-72
Lighting.....	5-73
Exterior Lights .....	5-73
Puddle Lamp.....	5-77
Welcome System.....	5-78
High Beam Assist (HBA) .....	5-79
High Beam Assist Settings.....	5-79
High Beam Assist Operation.....	5-80
High Beam Assist Malfunction and Limitations .....	5-80
Interior Lights.....	5-82
Interior Lamp AUTO cut .....	5-82
Front Lamps.....	5-82
Rear Lamps.....	5-83
Vanity Mirror Lamp.....	5-83
Glove Box Lamp .....	5-84
Foot Lamp.....	5-84
Trunk Lamp .....	5-84
Wipers and Washers .....	5-85
Front Windshield Wipers .....	5-85
Windshield Washers.....	5-87
Automatic climate control system .....	5-88
Automatic Heating and Air Conditioning .....	5-90
Manual Heating and Air Conditioning .....	5-91
System Operation .....	5-98
System Maintenance .....	5-99
Windshield Defrosting and Defogging.....	5-101
To Defog Inside Windshield.....	5-101
To Defrost Inside Windshield.....	5-102
Defogging Logic.....	5-102
Rear Window Defroster.....	5-103

# 5. Convenient Features

Climate Control Additional Features .....	5-104
Auto Defogging System .....	5-104
Automatic Ventilation .....	5-105
Recirculating Air when Washer Fluid is Used .....	5-106
Sunroof Inside Air Recirculation.....	5-106
Storage Compartment.....	5-107
Center Console Storage.....	5-107
Glove Box .....	5-108
Sunglass Holder .....	5-108
Interior Features.....	5-109
Cup Holder.....	5-109
Sunvisor .....	5-110
Power Outlet.....	5-110
USB Charger .....	5-111
Wireless Smart Phone Charging System .....	5-112
Clock .....	5-115
Coat Hook.....	5-115
Floor Mat Anchor(s).....	5-115
Luggage Net Holder.....	5-116
Infotainment System .....	5-117
USB Port.....	5-117
Antenna.....	5-117
Steering Wheel Remote Controls.....	5-118
Infotainment System.....	5-118
Voice Recognition .....	5-118
Bluetooth® Wireless Technology.....	5-119
Lexicon Premium Sound System .....	5-119

## ACCESSING YOUR VEHICLE

### Smart Key



ORG3050005

Your Genesis Branded Vehicle uses a Smart Key, which you can use to lock or unlock the driver/passenger doors and open the rear trunk.

1. Door lock
2. Door unlock
3. Trunk open
4. Panic
5. Remote start
6. Lamp on

### Locking your vehicle

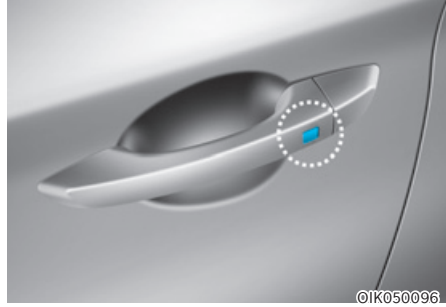

01K050096

To lock your vehicle using the door handle touch sensor or the Smart Key:

1. Make sure all doors, the hood and the trunk are closed.
2. Make sure you have the smart key in your possession.
3. Touch the touch sensor on the door handle (the engraved part) or press the Door Lock button (1) on the smart key. The hazard warning lights will blink.
4. Make sure the doors are locked by pulling the door handle.
  - When the vehicle is locked by using the touch sensor, the unlock sensor of door outside handle is not operated for around 3seconds.

### **i** Information

- The side view mirror will fold if 'Enable on Door Unlock' is selected from the Settings menu in the infotainment system screen. Select:
  - Setup → Vehicle Settings → Convenience → Welcome Mirror/Light → Enable on Door Unlock
- The door handle touch sensor will only operate when the smart key is within 28~40 in. (0.7~1 m) from the outside door handle.
- Touching the door handle touch sensor does not unlock the doors. To unlock the doors, refer to the following page.

Note that you cannot lock your vehicle using the door handle touch sensor if any of the following occurs:

- The Smart Key is in the vehicle.
- The Engine Start/Stop button is in ACC or ON position.
- Any of the doors are open except for the trunk.



### WARNING

**Do not leave the Smart Key in your vehicle with unsupervised children. Unattended children could press the Engine Start/ Stop button and may operate power windows, lock the doors or other controls, or even make the vehicle move, which could result in serious injury or death.**

### ***Unlocking your vehicle (When the Two Press Unlock feature is off)***

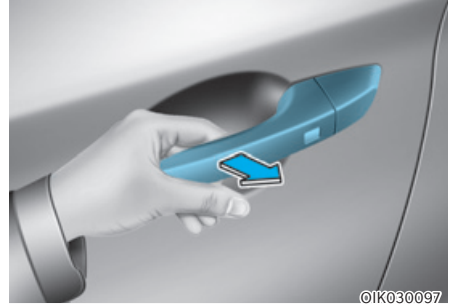

To unlock your vehicle using the door handle touch sensor or the Smart Key:

1. Make sure you have the smart key in your possession.
  2. Put your hand in the door handle or press the Door Unlock button (2) on the smart key. All doors will unlock and the hazard warning lights will blink two times and the chime will sound.
  3. After unlocking the doors, the doors will automatically relock after 30 seconds unless a door is opened.
- When the vehicle is unlocked by using the touch sensor, the lock sensor of door outside handle is not operated for around 2seconds.

### **Unlocking your vehicle (When the Two Press Unlock feature is on)**

To unlock your vehicle using the door handle touch sensor or the Smart Key:

1. Make sure you have the smart key in your possession.
  2. Put your hand in the door handle or press the Door Unlock button (2) on the smart key.
  3. The driver's door will unlock.
  4. If you touch the door unlock sensor inside of the front door handle to unlock the doors within 4 seconds, all of the doors unlock. When the doors unlock, the hazard warning lights will blink two times and the chime will sound.
  5. After unlocking the doors, the doors will automatically relock after 30 seconds unless a door is opened.
- The factory default setting is in off mode so you should set in the Settings menu in the infotainment system screen.
  - When the vehicle is unlocked by using the touch sensor, the lock sensor of door outside handle is not operated for around 2 seconds.

### Two Press Unlock Feature

The priority for unlocking the driver door only, or unlocking all the doors with one press may be adjusted in the Settings menu in the infotainment system screen.

The Two Press Unlock feature, when enabled, will require the user to press the door unlock button once for driver door only and twice for unlocking all the doors.

Setup → Vehicle Settings → Door → Two Press Unlock

The Two Press Unlock feature can also be enabled or disabled by pressing the door lock and unlock buttons simultaneously on the Key FOB:

Press and hold both the Door Lock button and the Door Unlock button simultaneously until the hazard warning lights blink.

This will enable or disable the Two Press Unlock feature. Repeat this procedure to enable/disable the mode again.

### **Information**

- **If you press the front passenger outside door handle with the smart key in your possession, all the doors will unlock.**
- **The Two Press Unlock feature is off when the vehicle is first delivered. To use the feature, enable the feature from the Settings menu in the infotainment system screen.**

## **i** Information

- The side view mirror will unfold if 'Enable on Door Unlock' is selected from the Settings menu in the infotainment system screen. Select:
  - Setup → Vehicle Settings → Convenience → Welcome Mirror/Light → Enable on Door Unlock
- The door handle touch sensor will only operate when the smart key is within 28~40 in. (0.7~1 m) from the outside door handle
- The doors may lock or unlock if the touch sensor of the outer door handle is recognized while washing your car or due to heavy rain.
- To prevent unintentional door lock or unlock:
 

You may prevent the doors from locking or unlocking unintentionally. Press the lock button on the smart key and immediately press the unlock button along with the lock button for more than 4 seconds. The hazard warning lights will blink four times. At this time, the doors will not lock or unlock even though the touch sensor is touched on the outside door handle.

To deactivate the function, press the door lock or unlock button on the smart key.
- The doors may not lock or unlock in the following situations.
  - If the touch sensor is touched with gloves on
  - If the door is suddenly approached

## Opening the trunk

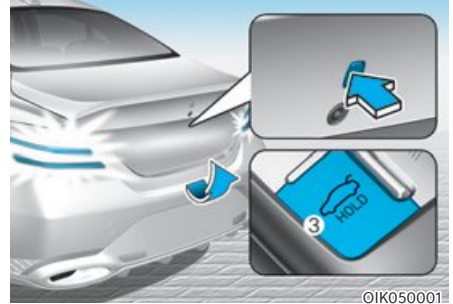

To open the trunk:

1. Make sure you have the smart key in your possession.
2. Press either the trunk open button on the vehicle or press and hold the Trunk Unlock button (3) on the smart key for more than one second. The hazard warning lights will blink two times and the trunk will open.

## **i** Information

The trunk open button will only operate when the smart key is within 28 in. (0.7 m) from the trunk.

## **Panic button**

Press and hold the Panic button (4) for more than one second. The horn sounds and hazard warning lights blink for about 30 seconds. To cancel the panic mode, press any button on the Smart Key.



### **Remotely starting vehicle**

You can start the vehicle using the Remote Start button (5) on the smart key.

To start the vehicle remotely:

1. Press the door lock button on the smart key within 32 feet (10 m) from the vehicle.
2. Press the Remote Start button (5) for more than 2 seconds within 4 seconds after pressing the door lock button.
3. The hazard warning lights will blink and the engine will start.
4. To turn off the remote start function, press the Remote Start button (5) once.

### ***i* Information**

- The vehicle must be in P (Park) for the remote start function to start.
- The engine turns off if you enter the vehicle without a registered smart key.
- The engine turns off if you do not get in the vehicle within 10 minutes after remotely starting the vehicle.
- The Remote Start button (5) may not operate if the smart key is not within 32 feet (10 m).
- The vehicle will not remotely start if the engine hood or trunk is open.
- Do not idle the engine for a long period.
- Do not operate remote start in closed areas where there is no adequate ventilation for the engine exhaust.

### **Turning on the lamps**

If the lamp on button (6) is pushed, the headlamps and tail lamps are turned on. However, it works only when the following conditions are satisfied:

- The vehicle is turned off.
- The doors are locked.
- The light control switch is in the AUTO headlamp position (The headlamps and tail lamps will turn on when it is dark.) or in the Headlamp position.

### **Start-up**

You can start the vehicle without inserting the key.

**For more details, refer to the “Engine Start/Stop Button” section in chapter 6.**

### ***i* Information**

If the smart key is not moved for some time, the detection function for smart key operation will pause. Lift the smart key to activate the detection again.

### **NOTICE**

To prevent damaging the smart key:

- Keep the smart key in a cool, dry place to avoid damage or malfunction. Exposure to moisture or high temperature may cause the internal circuit of the smart key to malfunction which may not be covered under warranty.
- Avoid dropping or throwing the smart key.
- Protect the smart key from extreme temperatures.

### **Mechanical key**

If the Smart Key does not operate normally, you can lock or unlock the driver's door by using the mechanical key.

To remove the mechanical key from the smart key FOB:



OJX1059007

1. Place a soft cloth over the groove (A), and pry open the smart key cover.

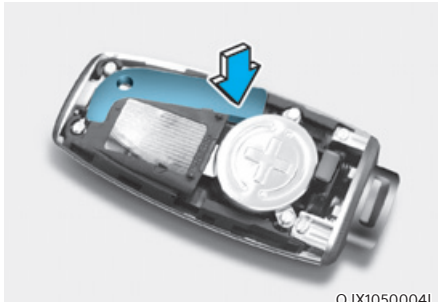

OJX1050004L

2. Press the mechanical key and remove it from the smart key FOB.
3. After use, reinstall the mechanical key and smart key cover in the reverse order of removal.

### **Loss of a smart key**

A maximum of two Smart Keys can be registered to a single vehicle. If you happen to lose your smart key, it is recommended that you should immediately take the vehicle and remaining keys to your authorized retailer of Genesis Branded products or tow the vehicle, if necessary.

### **Smart key precautions**

The smart key may not work if any of the following occurs:

- The smart key is close to a radio transmitter such as a radio station or an airport which can interfere with normal operation of the transmitter.
- The smart key is near a mobile two way radio system or a mobile phone.
- Another vehicle's smart key is being operated close to your vehicle.

If the smart key does not work correctly, open and close the door with the mechanical key. If you have a problem with the smart key, it is recommended to contact an authorized retailer of Genesis Branded products.

If the smart key is in close proximity to your mobile phone, the signal could be blocked by your mobile phone's normal operational signals. This is specifically relevant when the phone is active such as making and receiving calls, text messaging, and/or sending/receiving emails. When possible, avoid keeping the smart key and your mobile phone in the same location such as a pants or jacket pocket in order to avoid interference between the two devices.

## **i** Information

This device complies with Part 15 of the FCC rules.

Operation is subject to the following three conditions:

1. This device may not cause harmful interference, and
2. This device must accept any interference received, including interference that may cause undesired operation.
3. Changes or modifications not expressly approved by the party responsible for compliance could void the user's authority to operate the device.

## **NOTICE**

- Keep the smart key away from electromagnetic materials that blocks electromagnetic waves to the key surface.
- Always have the smart key with you when leaving the vehicle. If the smart key is left near the vehicle, the vehicle battery may be discharged.

## **Battery replacement**

If the Smart Key is not working properly, try replacing the battery with a new one.

Battery Type: CR2032

To replace the battery:



OJX1059007

1. Place a soft cloth over the groove (A), and pry open the smart key cover.

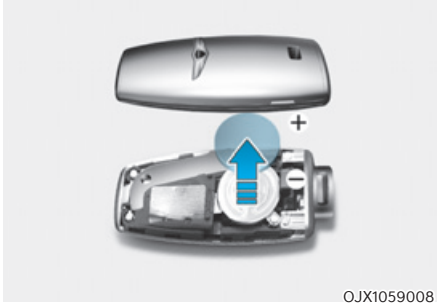

OJX1059008

2. Remove battery cover using a phillips screwdriver.
3. Remove the old battery and insert the new battery. Make sure the battery position is correct.
4. Reinstall the battery cover and smart key cover in the reverse order of removal.

If you suspect your smart key might have sustained some damage, or you feel your smart key is not working correctly, it is recommended that you contact an authorized retailer of Genesis Branded products.

### **i** Information



**An inappropriately disposed battery can be harmful to the environment and human health. Dispose of the battery according to your local law(s) or regulations.**

### **Restrictions in handling keys**

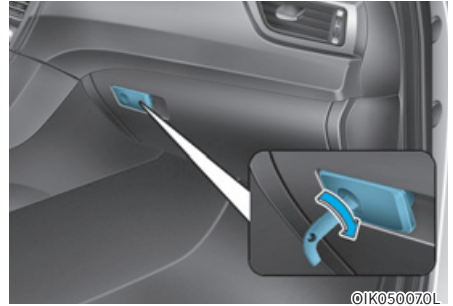

©IK050070L

When leaving keys with parking lot and valet attendants, the following procedures will ensure your vehicle's glove box compartment can only be opened with the mechanical key.

To lock:

1. Remove the mechanical key from the Smart Key.
2. Lock the glove box using the mechanical key.
3. Leave the smart key with the attendant and keep the mechanical key with you.

The Smart Key can only be used to start the engine and operate door locks.

To unlock:

Open the glove box with the mechanical key.

### Immobilizer System

The immobilizer system helps protect your vehicle from theft. If an improperly coded key (or other device) is used, the engine's fuel system is disabled.

When the Engine Start/Stop button is pressed to the ON position, the immobilizer system indicator should come on briefly, then go off. If the indicator starts to blink, the system does not recognize the coding of the key.

Press the Engine Start/Stop button to the OFF position, then press the Engine Start/Stop button to the ON position again.

In some circumstances, the vehicle may not recognize your smart key if another smart key device is nearby or a metal object such as a key chain is causing interference with the smart key.

If this occurs, your vehicle may not start. Remove any metal objects or additional keys near the smart key before attempting to start the vehicle again.

If the system repeatedly does not recognize the coding of the key, it is recommended that you contact your retailer of Genesis Branded products.

Do not attempt to alter this system or add other devices to it. Electrical problems could result that may make your vehicle inoperable.



### WARNING

**In order to prevent theft of your vehicle, do not leave spare keys anywhere in your vehicle. Your immobilizer password is a customer unique password and should be kept confidential.**

### NOTICE

**The transponder in your key is an important part of the immobilizer system. It is designed to give years of trouble-free service, however you should avoid exposure to moisture, static electricity and rough handling. Immobilizer system malfunction could occur.**



### Information

**This device complies with Part 15 of the FCC rules.**

**Operation is subject to the following three conditions:**

- 1. This device may not cause harmful interference.**
- 2. This device must accept any interference received, including interference that may cause undesired operation.**
- 3. Changes or modifications not expressly approved by the party responsible for compliance could void the user's authority to operate the device**

## GENESIS DIGITAL KEY

Genesis digital key provides convenience to the driver, which the driver can use to lock or unlock the driver and passenger doors or the trunk and turn on the engine.

### Digital Key (Smart Phone)

#### **How to register Digital Key (Smart phone)**

To use the smart phone as a digital key follow the following procedure.

This service is only available for Android smart phones that passed the internal usability test. The driver can confirm supported/compatible devices on our website (<https://owners.genesis.com>). In case of iPhone, Apple does not assist any of the NFC services. (Services are expected to be provided according to policy change.)

#### **Genesis Digital Key App**

1. Search 'Genesis digital key' from the Google Play Store and download the app. Please refer to the detailed manual of the digital key app or Genesis website. The option can be found under the following app menu: Menu → Application Info → Tutorial. Please note the manual before using the app.
2. After downloading the app, sign up for a Genesis account and service.

#### **Smart phone set up**

- The driver can use the Digital Key NFC (Near Field Communication) feature after enabling it on the smart phone's setting menu. To change the NFC setting of the smart phone, please refer to the smart phone manual or contact the customer service center of smart phone manufacturers.
- The driver should unlock and turn on the smart phone screen. (Unlock the screen lock such as password, pattern or fingerprint, etc.)

#### **Smart phone registration**

1. Turn the vehicle on with the Smart key and make sure to keep the smart key inside the vehicle during digital key registration.
2. Open Genesis Digital Key App in the vehicle owner's smart phone and activate the digital key registration screen after selecting the vehicle to register.

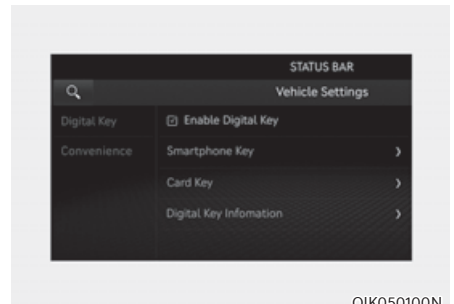

OIK050100N

3. From the infotainment system settings menu, select 'Setup → Vehicle → Digital Key → Enable Digital Key'.

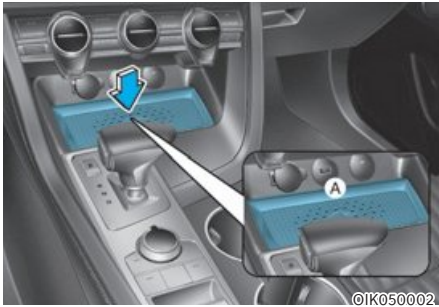

[A] : In-vehicle authentication pad (Wireless charging pad)

- After 'Enabling Digital Key' is selected, place the backside of the smart phone on the in-vehicle authentication pad.

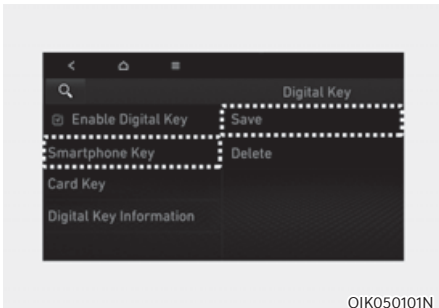

OIK050101N

- Select 'Smartphone key → Save' menu on the infotainment system screen. The saving process will begin automatically.
- When the digital key (smart phone) is saved, a message will appear on the infotainment system screen.
- Remove the smart phone from the pad and complete the saving process under the guidance of the smart phone screen.

## **i** Information

- Vehicle**  
When there is a digital key (smart phone) already saved in the vehicle, the 'Save' menu is disabled. If you want to save a digital key again, refer to "How to delete Digital Key (Smart phone)" and follow the deleting procedure first before saving a digital key.
- Smart phone**  
The digital key cannot be saved again while the vehicle's digital key is saved in the owner's smart phone. Save the digital key after deleting the digital key from the Digital Key App.
- During the digital key saving process, the process will cancel when:**
  - The smart phone is removed from the in-vehicle authentication pad (wireless charging pad)
  - Changing the infotainment system or instrument cluster screen
  - The vehicle is turned off
  - The gear is shifted
  - Saving digital key that does not belong to the vehicle owner
  - The smart phone screen is locked or turned off
  - NFC setting of your smart phone is off (saving process will not begin)
  - There is no smart key (saving process will not begin)

## How to Use the Digital Key (Smart phone)

### Smart phone touch control

The driver can lock and unlock the door by touching the smart phone on the door handle without activating the Digital Key App. Also, the engine can be started by placing the smart phone on the in-vehicle authentication pad (wireless charging pad).



[A] : Door handle authentication pad

[B] : NFC antenna (Backside of the smart phone) (The antenna position differs depending on models.)

### • Locking/Unlocking the doors

- If the driver touches the smart phone NFC antenna to the driver's or passenger's door handle authentication pad for more than 2 seconds, the door will lock or unlock.
- If Two Press Unlock function is set, only the driver's door will be unlocked by touching the smart phone on the driver's door handle. Touch the smart phone once more within 4 seconds to unlock all doors.
- After unlocking the doors, the doors will automatically re-lock after 30 seconds unless a door is opened.
- If the smart phone digital key does not operate, move the smart phone more than 4 in. (0.1 m) from the door handle authentication pad and try it again.

Note that you cannot lock your vehicle using the smart phone NFC antenna if any of the following occur:

- The Smart Key is in the vehicle
- The Engine Start/Stop button is in ACC or ON position
- Any of the doors are open except for the engine hood or trunk

### • Starting the engine

1. After placing your registered smart phone on the in-vehicle authentication pad (wireless charging pad), depress the brake pedal and press the Engine Start/ Stop button.
2. After starting the engine, the digital key data will be automatically updated. It will take 5 to 20 seconds. After that, the smart phone will automatically go into the wireless charging mode. Once the engine is started, you can remove the smart phone from the pad.

**For more details, refer to the “Engine Start/Stop Button” section in chapter 6.**

### **i** Information

**To lock/unlock the doors and/or start the engine with the smart phone Digital Key, always turn on and unlock the smart phone screen.**



### **i** Information

- After the battery has been reconnected or the battery has been recharged, it will take time for the digital key (smart phone) to operate due to remote security update. When locking or unlocking the door with the smart phone NFC antenna, touch and hold the smart phone on the door handle until the door(s) is locked or unlocked.
- If the mobile data connection of the smart phone is weak, remote security information update may fail. At this time, use the card key to lock or unlock the doors, or start the engine. When you are in a place where the mobile data connection of your smart phone is available, place your smart phone on the in-vehicle authentication pad (wireless charging pad) and start your vehicle, or touch the digital key on the door handle to lock or unlock the door, the remote security information will be automatically updated. Even though the engine is not started, wait until the remote security information is updated and the in-vehicle authentication pad (wireless charging pad) changes to charging mode.

### **⚠** WARNING

The engine can be started when the registered smart phone is placed on the in-vehicle authentication pad (wireless charging pad). Therefore, do not leave unsupervised children or people who are not aware of the system since it can result in serious injury or death. In addition, always have the registered smart phone with you to prevent vehicle theft when leaving the vehicle.

### Digital key App remote control

Various control functions such as Door Lock/Unlock, Remote Start, Panic and Trunk Open/Close are available using the Digital Key App. To use the Digital Key App functions, the smart phone's Bluetooth must be activated, and must be approximately within 32 ft. (10 m) from the vehicle.

- **Connecting Digital Key App with the vehicle**
  1. Open the Genesis Digital Key App in the smart phone. Select the vehicle you want to control from the vehicle list in the App.
  2. Approach the vehicle with the Genesis Digital Key App opened. The Digital Key App will automatically connect with the vehicle.
  3. When the connection is complete, the icons in the Digital Key App will become active.
- **Controlling the vehicle with Digital Key App**



OIK050111

Press the icons to remotely control the vehicle.

1. Lock Doors
2. Unlock Doors
3. Panic On
4. Panic Off
5. Remote Engine On
6. Remote Engine Off
7. Open Trunk

The icon will be highlighted or an alarm and vibration will also be provided when the selected icon function is being performed.

After the Digital Key App and vehicle are connected, if Digital Key App remote control is not used over 5 minutes, the connection between the app and vehicle will disconnect automatically.

Note that you cannot lock your vehicle using Genesis Digital Key APP if any of the following occurs:

- The Engine Start/Stop button is in the ACC or ON position
- Door(s) is open

• **Remotely starting vehicle with the Digital Key App**

1. Press the Door Lock button in Genesis Digital Key App.
2. Press the Remote Engine On icon within 4 seconds.
3. The hazard warning lights will blink and the engine will start.
  - Unless the driver puts the registered digital key (smart phone) on the in-vehicle authentication pad (wireless charging pad) when the Remote Start function is on, the engine will turn off.
  - If the driver does not get in the vehicle within 10 minutes after the engine is remotely started, the engine will turn off.



**CAUTION**

- **If the vehicle windows are tinted with a film containing metallic substances, it may cause poor Bluetooth connection and poor performance of the Digital Key App.**

- **If multiple users use the digital key at the same time, the functions of the Digital Key App may not work properly. Only the necessary user should operate the Digital Key App remote control.**
- **When using the Digital Key App remote control, the driver (the remote control user) should leave the vehicle after checking that the doors are locked. When the doors are locked, the chime will sound and the hazard warning lights will blink once.**
- **The remote functions of the Digital Key App enables the vehicle to be controlled when the user is within operating range. If the digital key is out of the operating range, the remote control function may not operate properly.**
- **If the smart phone is moved away from the vehicle while the smart phone and the vehicle is connected, Digital Key App remote control may not operate properly.**
- **When using Digital Key App remote control via Bluetooth, communication may be slow or the operating range may be reduced in the following circumstances:**
  - **Smart phone mobile data is weak**
  - **Bluetooth connection is weak due to many Bluetooth devices**
  - **There is an object such as metal or concrete between the vehicle and smart phone**
  - **The smart phone is wrapped in your hand or other electronic devices that cause interference is placed near the smart phone**
- **If you use a smart phone cover that uses wireless communication or is made of metal, the digital key NFC function may not work properly. Remove the smart phone cover before using the digital key NFC function.**

- If Digital Key App remote control does not operate properly, use the smart phone's NFC function to lock and unlock the doors.

### How to delete Digital Key (Smart Phone)

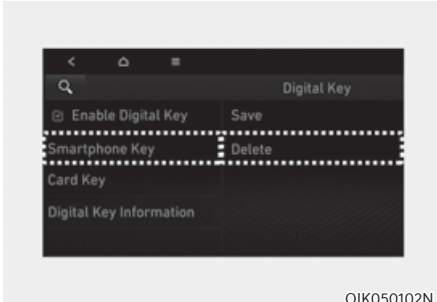

OIK050102N

1. Turn the vehicle on with the smart key and make sure to keep the smart key inside the vehicle during the digital key (smart phone) deleting process.
2. From the infotainment system settings menu, select 'Setup → Vehicle → Digital Key → Smartphone key → Delete'. The 'Delete' menu will be disabled if there is no digital key (smart phone) saved.
3. When the digital key (smart phone) is deleted, a message will appear on the infotainment screen or cluster.
4. Go to 'Initialize Digital Key' menu in the Digital Key App and select the vehicle to delete the digital key information.

### What to do when user changes smart phone or deletes app

If the driver changes his/her smart phone or has deleted the Genesis Digital Key App, refer to the following to set up the Genesis Digital Key App again.

#### Smart phone change

Follow the procedure below to use the digital key in your new smart phone.

1. Install the Genesis Digital Key App and log in.
2. From the infotainment system settings menu, first delete the previous digital key (Digital Key → Smart phone key → Delete), and then save the digital key again.
3. If you have shared the digital key with others, you will need to re-share the digital key.

#### Smart phone reset/App delete & reinstall/ App data delete

Follow the procedure below to use the digital key when the smart phone was reset, the app was deleted and then reinstalled, or the app data was deleted.

1. Install the Genesis Digital Key App and log in.
2. Input the PIN number for user verification. If PIN is correct, digital key data will be downloaded to the user's smart phone and you can use the digital key without any further registration or sharing procedure.

#### Smart phone operability with Digital Key

The Digital Key App may not be available on some smart phones. Check for available smart phone models on the Genesis website. The smart phone NFC antenna location guide can be confirmed on the Genesis website or contact the smart phone manufacturer's customer service center.

## Digital Key (Card Key)

### How to register Digital Key (Card Key)

To use the card key as a digital key, follow the following procedure.

#### For Android smart phones

1. Install Genesis digital key app in main user's smart phone and register the digital key (smart phone). Please refer to the registration method of the digital key (smart phone).

1-1. Activate Genesis digital key app and then select "Menu → Settings → Card Key Enroll Authentication". Please follow the digital key authentication procedure according to the app.

- Bluetooth authentication : Before starting the process, the driver needs to make sure to check whether the Bluetooth connection is working properly. To enroll the card key, please select "Menu → Settings → Card Key Enroll Authentication" in the top right corner of the digital key app. The card saving process should be completed within 5 minutes after the authentication process is done in the vehicle.
- NFC authentication : After selecting NFC authentication, please contact the smart phone on the driver's or passenger's outside door handle.

1-2. Get in the vehicle with the smart key.

#### Except Android smart phones

1. Get in the vehicle with two smart keys.

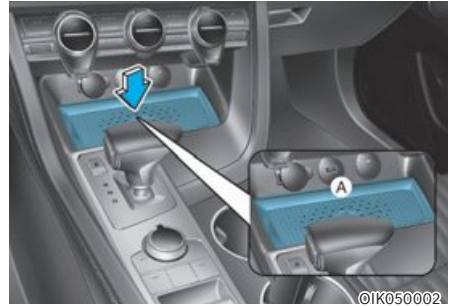

[A] : In-vehicle authentication pad (Wireless charging pad)

2. Place the NFC card key on the in-vehicle authentication pad.

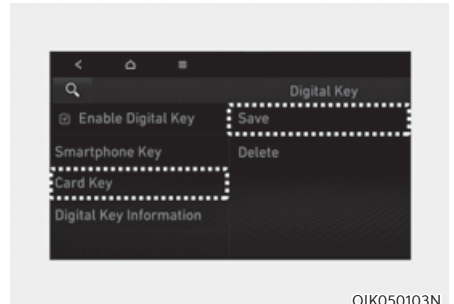

3. From the infotainment system settings menu, select 'Setup → Vehicle → Digital Key → Card Key → Save'. The saving process will begin automatically.
4. When the digital key (card key) is saved, a message will appear on the infotainment system screen.

## **i** Information

- When there is a digital key (card key) already saved in the vehicle, the ‘Save’ menu is disabled. If you want to save a digital key again, refer to “How to delete Digital Key (Card key)” and follow the deleting procedure first before saving a digital key.
- When registering a digital key (card key), authentication is required once through a smart phone. Complete the registration within 5 minutes after authentication.
- To register the digital key (card key), the smart key must be in the vehicle.
- The registered digital key (card key) cannot be used for another vehicle.
- The previously saved digital key (card key) can be not used if a new digital key (card key) is registered.

## **How to use the Digital key (Card key)**

### Card key touch control

The driver can lock and unlock the door by touching the card key on the door handle. Also, the engine can be started by placing the card key on the in-vehicle authentication pad (wireless charging pad).



[A] : Door handle authentication pad, [B] : Card key NFC antenna

### • Locking/Unlocking the doors

- If the driver touches the card key on the driver's or passenger's door handle authentication pad for more than 2 seconds, the door will lock or unlock.
- If Two Press Unlock function is set, only the driver's door will be unlocked by touching the card key on the driver's door handle. Touch the card key once more within 4 seconds to unlock all doors.
- After unlocking the doors, the doors will automatically re-lock after 30 seconds unless a door is opened.

Note that you cannot lock your vehicle using the NFC antenna if any of the following occur:

- The Smart Key is in the vehicle
- The Engine Start/Stop button is in ACC or ON position
- Any of the doors are open except for the engine hood or trunk
- **Starting the engine**

After placing your registered card key on the in-vehicle authentication pad (wireless charger pad), depress the brake pedal and press the Engine Start/ Stop button.

For more details, refer to the “Engine Start/Stop Button” section in chapter 6.



### **WARNING**

The engine can be started when the registered card key is placed on the in-vehicle authentication pad (wireless charging pad). Therefore, do not leave unsupervised children or people who are not aware of the system since it can result in serious injury or death. In addition, always have the registered card key with you to prevent vehicle theft when leaving the vehicle.



### **CAUTION**

- The digital key (card key) may not work under the following conditions:
  - The card key is not touching the center of the door handle authentication pad or in-vehicle authentication pad (wireless charging pad) correctly.
  - The card key is used overlapped with NFC-enabled cards such as credit card or smart phone.
  - If the card key does not work, move the card key approximately 4 in. (10 cm) away from the authentication pad and then touch it again.
- The card key can be damaged by impacts. If the key is damaged, replace the card key with a new one and register it again.
- Long-time exposure to high temperature may cause the card key to malfunction. Be careful not to expose the key to direct sunlight or high temperature.
- The card key is consumable and it is not covered by your warranty. Therefore, the result of misuse by customers such as breakage or loss is not subject to guarantee.
- Always have the card key with you when leaving the vehicle. If the authenticated phone has a dead battery, or it is lost or stolen, you may be locked out of the vehicle.

### How to delete Digital Key (Card key)

1. Turn the vehicle on with the smart key and make sure to keep the smart key inside the vehicle during the digital key (card key) deleting process.

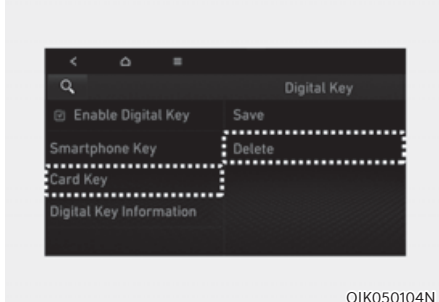

2. From the infotainment system settings menu, select 'Setup → Vehicle → Digital Key → Card Key → Delete'. The 'Delete' menu will be disabled if there is no digital key (card key) saved.
3. When the digital key (card key) is deleted, a message will appear on the infotainment screen or cluster.

### Personalized Profile and Vehicle Settings

When the registered digital key is linked with user profile, the vehicle will automatically operate (door lock/unlock with digital key, etc.) according to the user profile linking setting. User profile linking and personalization are available for a total of two drivers.

#### Linking / Unlinking profile

##### How to link user profile

1. Select 'Setup → User Profile → Profile Settings → Link Digital Key (Smartphone)' on the infotainment system settings menu.
2. Unlock the smart phone, enable the NFC feature, and place it on the in-vehicle authentication pad (wireless charging pad) according to the message on the infotainment system screen.
3. User profile linking will start with the message 'Linking... Pressing any button will cancel linking the Digital Key'.
4. If you select 'Link', the registered phone number's digital key and the user profile will link. Select 'Link' according to the instruction.
5. When the process is complete, the message 'Digital Key Link Complete.' will appear on the infotainment system screen.

##### How to unlink user profile

1. Unlink digital key in the User Profile settings. Unlinking is possible only when user profile is linked.
2. When unlinking is complete, the message 'Digital key is unlinked.' will appear on the infotainment system screen.

## **i** Information

- Use profile cannot be linked to both Driver 1 and Driver 2 that are connected to a single smart phone. Personalization will operate with the recently linked user profile, and the previously linked user profile will be automatically canceled.
- User profile can be linked when digital key is enabled (Set up → Vehicle → Digital Key → Enable Digital Key). The linked user profile information is maintained even when the digital key function is disabled. User profile can be linked to a smart phone with the Digital Key App installed.
- User profile can be linked when a digital key is registered on the smart phone and the vehicle. The smart phone with another vehicle's digital key cannot be linked.
- If you remove the smart phone from the in-vehicle authentication pad (wireless charging pad) before completing the user profile link, the linking process will not be completed normally.
- To unlink the user profile, the smart phone does not need to be on the in-vehicle authentication pad (wireless charging pad).
- Once the user profile linked digital key in the smart phone is deleted, the digital key should be re-registered and personalized by linking the user profile again.

## **Vehicle personalization operation**

The personalization function linked with digital key works under the following conditions:

- Touch the driver's door handle with the profile linked smart phone to lock or unlock the doors (Personalization does not operate when locking or unlocking the front passenger door.).
- When the remote door unlock with the profile linked smart phone digital key app works, the user profile linked with digital key can be changed manually from the infotainment system settings.

## **i** Information

User profile operation according to door lock/unlock system is as follows.

Item	Personalization operation
Initial value	Guest
Profile linked smart phone key	Linked profile
Profile unlinked smart phone key	Recently activated profile
NFC card key	
Smart key	

- The personalization function using the digital key can be operated after linking the digital key in the infotainment system profile menu.
- The personalization function works only when the engine is OFF or when the engine is started remotely. If the engine is not started remotely, personalization function does not work with the digital key.



**Vehicle personalization with digital key**

The available personalization function in the vehicle is as follows.

System	Personalization Item	
USM	Head Up Display (HUD)	Position adjustment of image, Information display selection
	Lamp	Blink number of one-touch signal lamps
	Cluster	Information display on the cluster, Voice volume, Welcome sound
	Seat/Mirror/Steering wheel	Seat position, O/S mirror position, Steering wheel position, Easy Access
		Smart heating wire/ventilation On/Off
	Door	Automatic door lock/unlock, Two Press Unlock
	Smart phone wireless charging	Wireless charging On/Off
Air conditioning	Setting up temperature unit, Block air inflow/Automatic ventilation/Window defroster On/Off	
Infotainment menu	Navigation	Preferred volume of the navigation system
		Recent destination
	User preset	Radio preset
Phone connectivity	Bluetooth preferential connection	
	CarPlay/Android Auto On/Off	
Air conditioning	Operating condition	Latest operation setup of the following functions: Temperature (AUTO), air flow direction, air volume, air conditioner, air intake control, SYNC, Front windshield defroster, OFF

For more information of personalization, refer to the infotainment system manual.

 **CAUTION**

**If you leave the digital key in the vehicle after locking or unlocking the doors or starting the vehicle with the smart key, the doors can be locked with the central door lock. Have the digital key with you at all times.**

## Used Vehicle/Digital Key Maintenance

### ***Purchasing used vehicle***

If any of the digital key devices (smart phone key, card key) are registered in the vehicle, the message 'Digital key(s) active' will appear on the instrument cluster once when the vehicle is turned on after unlocking the vehicle door. When purchasing a used car, be sure to check the message and delete the smart phone key and card key registered by the previous user. Please let us know the purchase of a used vehicle through Genesis Customer Care. Check whether the card key that came with the used vehicle operates properly. If the card key does not work properly, delete the card key and register the smart phone key, and then re-register the card key.

### ***Digital Key Maintenance***

If you need to have your Digital Key System repaired or replaced, the registered smart key/card key can be deleted. In this case, you should delete the digital key on the smart phone and re-register the key.

## Limitations of the System

- Genesis Digital Key App on the smart phone and card key may not work if any of the following occurs:
  - The Digital Key App in the smart phone is deleted (reinstall the app)
  - Account log information of Genesis Digital Key App is expired (required to re-log in)
  - When you try to log in from another smart phone instead of the registered smart phone with same user account - Smart phone rooting or app hacking is detected
  - Smart phone battery or the vehicle battery is discharged
  - Smart phone's screen is off or locked
  - NFC or Bluetooth is turned off in the smart phone settings
  - Smart phone's mobile network setting is off or airplane mode is activated
  - A credit card is overlapped in the back of your smart phone, or metal or thick smart phone case is used
  - Using the card key with other cards, or using it in a wallet or card holder
  - There is electronic interference by other vehicles, objects, etc.
- The vehicle may not be controlled by the smart phone if any of the following occurs:
  - Basic and necessary functions of the smart phone are operating (general call, urgent call, audio or NFC payment)
  - Using wireless earphone

## DOOR LOCK

### Operating Door Locks from Outside the Vehicle

#### Mechanical key

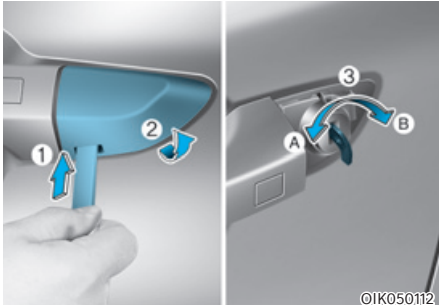

In order to operate door lock by using mechanical key, turn the key after removing the cover.

To remove the cover :

1. Pull out the door handle.
2. Press the lock located at the bottom of the cover with a key or flat-head screwdriver (1).
3. Push out the cover (2) while pressing the lock.

After removing the cover, turn the key clockwise to lock (A) or turn the key counterclockwise to unlock (B).

If you lock/unlock the driver's door with a mechanical key, the door of driver will lock/unlock automatically, not others. Namely, the driver's door and the rest of the doors are not interlocked in terms of mechanical key.

Once the doors are unlocked, they may be opened by pulling the door handle. When closing the door, push the door by hand. Make sure that doors are closed securely.

#### NOTICE

Do not apply excessive force on the door and door handle. It may damage the door and door handle.

#### **i** Information

When the keyhole freezes and does not open, lightly tap or indirectly warm (i.e. hand temperature) the keyhole.

#### Smart key

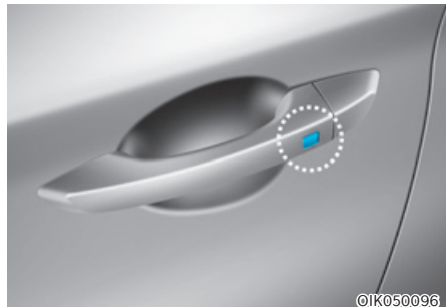

#### Lock

Touch the touch sensor on the front outside door handle (the engraved part) while carrying the Smart Key with you or press the Door Lock button on the Smart Key, all doors will lock.

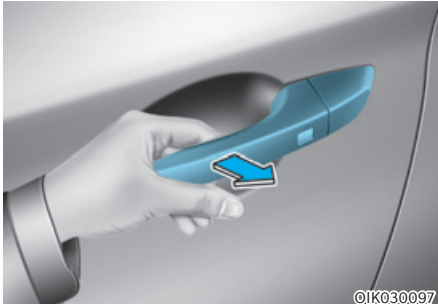

### Unlock

Put your hand in the front outside door handle while carrying the Smart Key with you or press the Door Unlock button on the Smart Key, all doors will unlock.

Once the doors are unlocked, they may be opened by pulling the door handle.

When closing the door, push the door by hand. Make sure that doors are closed securely.

**For more details, refer to “Smart Key” in the previous pages.**

### **i** Information

- In cold and wet climates, door lock and door mechanisms may not work properly due to freezing conditions.
- If the door is locked/unlocked multiple times in rapid succession with either the vehicle key or door lock switch, the system may stop operating temporarily in order to protect the circuit and prevent damage to system components.

## Operating Door Locks from Inside the Vehicle

### With the door handle

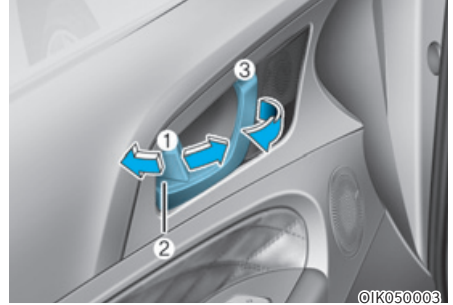

- To unlock a door, push the door lock button (1) to the “Unlock” position. The red mark (2) on the door lock button will be visible.
- To lock a door, push the door lock button (1) to the “Lock” position. If the door is locked properly, the red mark (2) on the door lock button will not be visible.
- To open a door, pull the door handle (3) outward.
- If the inner door handle of the driver’s (or front passenger’s) door is pulled when the door lock button is in the lock position, the button is unlocked and the door opens.
- Doors cannot be locked if the smart key is in the vehicle and any door is open.

**i** Information

If a power door lock ever fails to function while you are in the vehicle try one or more of the following techniques to exit:

- Operate the door unlock feature repeatedly (both electronic and manual) while simultaneously pulling on the door handle.
- Operate the other door locks and handles, front and rear.
- Lower a front window and use the mechanical key to unlock the door from outside.

**i** Information

When the vehicle's battery run out and you leave the vehicle, make sure all the doors are locked. You can lock the driver's door with a key and the rest of the doors with the lock button above the door inside handle.

**With the central door lock switch**

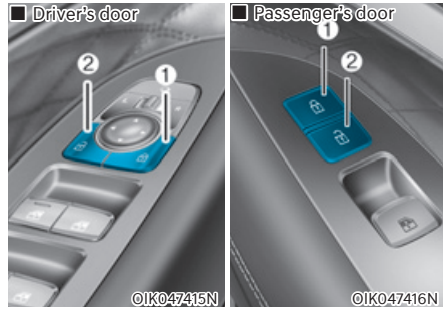

When pressing the (🔒) switch (1), all vehicle doors will lock.

When pressing the (🔓) switch (2), all vehicle doors will unlock.

If the smart key is in the vehicle and any door is opened, the doors will not lock even though the lock button (1) of the central door lock switch is pressed.

 **WARNING**

- The doors should always be fully closed and locked while the vehicle is in motion. If the doors are unlocked, the risk of being thrown from the vehicle in a crash is increased.
- Do not pull the inner door handle of the driver's or passenger's door while the vehicle is moving.

 **WARNING**

Do not leave children or animals unattended in your vehicle. An enclosed vehicle can become extremely hot, causing death or serious injury to unattended children or animals who cannot escape the vehicle. Children might operate features of the vehicle that could injure them, or they could encounter other harm, possibly from someone gaining entry to the vehicle.

 **WARNING**

Always secure your vehicle.

Leaving your vehicle unlocked increases the potential risk to you or others from someone hiding in your vehicle.

To secure your vehicle, while depressing the brake pedal, shift the vehicle to P(Park), apply the parking brake, and press the Engine Start/Stop button to the OFF position, close all windows, lock all doors, and always take the Smart Key with you.

 **CAUTION**

Opening a door when something is approaching may cause damage or injury. Be careful when opening doors and watch for vehicles, motorcycles, bicycles or pedestrians approaching the vehicle in the path of the door.

 **WARNING**

If you stay in the vehicle for a long time while the weather is very hot or cold, there are risks of injuries or danger to life. Do not lock the vehicle from the outside when someone is in the vehicle.

## Automatic Door Lock and Unlock Features (if equipped)

Your vehicle is equipped with features that will automatically lock or unlock your vehicle based on settings you select in the infotainment system screen.

### **Auto LOCK Enable on speed**

When this feature is set in the infotainment system screen, all the doors will be locked automatically when the vehicle exceeds 9 mph (15 km/h).

### **Auto LOCK Enable on shift**

When this feature is set in the infotainment system screen, all the doors will be locked automatically when the vehicle is shifted out of P (Park) while the engine is running.

### **Auto UNLOCK On Shift to P**

When this feature is set in the infotainment system screen, all the doors will be unlocked automatically when the vehicle is shifted back into P (Park) while the engine is running.

### **Auto UNLOCK Vehicle off**

When this feature is set in the infotainment system screen, all the doors will be unlocked automatically when the vehicle is turned off.

**See additional information in supplied Infotainment Manual.**

### **Additional unlock safety feature air bag deployment**

As an additional safety feature, all doors will be automatically unlocked when an impact causes the air bags to deploy.

## Child-Protector Rear Door Locks (if equipped)



The child safety lock is provided to help prevent children seated in the rear from accidentally opening the rear doors. The rear door safety locks should be used whenever children are in the vehicle.

The child safety lock is located on the edge of each rear door. When the child safety lock is in the lock position, the rear door will not open if the inner door handle (2) is pulled.

To lock the child safety lock, insert a small flat blade tool (like a screwdriver or similar) (1) into the slot and turn it to the lock position as shown.

To allow a rear door to be opened from inside the vehicle, unlock the child safety lock.



### **WARNING**

**If children accidentally open the rear doors while the vehicle is in motion, they could fall out of the vehicle. The rear door safety locks should always be used whenever children are in the vehicle.**

## THEFT-ALARM SYSTEM

This system helps to protect your vehicle and valuables. The horn will sound and the hazard warning lights will blink continuously if any of the following occur:

- A door is opened without using the smart key.
- The trunk is opened without using the smart key.
- The engine hood is opened.

The alarm continues for 30 seconds, then the system resets. To turn off the alarm, unlock the doors with the smart key.

The Theft Alarm System automatically sets 30 seconds after you lock the doors and the trunk. For the system to activate, you must lock the doors and the trunk from outside the vehicle with the smart key or by touching the touch sensor on the outside of the door handle with the smart key in your possession.

The hazard warning lights will blink and the chime will sound once to indicate the system is armed.

Once the security system is set, opening any door, the trunk, or the hood without using the smart key will cause the alarm to activate.

The Theft Alarm System will not set if the hood, the trunk, or any door is not fully closed. If the system will not set, check the hood, the trunk, or the doors are fully closed.

Do not attempt to alter this system or add other devices to it.

### Information

- **Do not lock the doors until all passengers have left the vehicle. If the remaining passenger leaves the vehicle when the system is armed, the alarm will be activated.**
- **If the vehicle is not disarmed with the smart key, open the doors by using the mechanical key and start the engine by directly pressing the Engine Start/Stop button with the smart key.**
- **If the system is disarmed by unlocking the vehicle, but neither a door or the trunk is opened within 30 seconds, the doors will relock and the system will rearm automatically.**



## INTEGRATED MEMORY SYSTEM

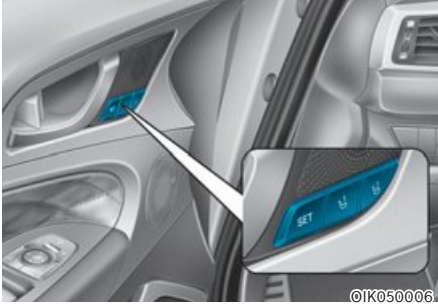

Integrated Memory System for the driver's seat is provided to store and recall the following memory settings with a simple button operation.

- Driver's seat position
- Steering wheel position (power adjustment)
- Side view mirror position



### WARNING

**Never attempt to operate the integrated memory system while the vehicle is moving.**

**This could result in loss of control, and an accident causing death, serious injury, or property damage.**



### Information

- **If the battery is disconnected, the memory settings will be erased.**
- **If integrated memory system does not operate normally, have the system inspected by an authorized retailer of Genesis Branded products.**

## Storing Memory Positions

1. Shift to P (Park) while the Engine Start/Stop button is in the ON position.
2. Adjust the driver's seat position, side view mirror position, steering wheel position to the desired position.
3. Press the SET button. The system will beep once and notify you 'Press button to save settings' on the cluster LCD display.
4. Press one of the memory buttons (1 or 2) within 4 seconds. The system will beep twice when the memory has been successfully stored.
5. 'Settings 1(or 2) saved' will appear on the cluster LCD display. The message appears only for the driver's seat position memory setting.

## Recalling Memory Positions

1. Shift to P (Park) while the Engine Start/Stop button is in the ON position.
2. Press the desired memory button (1 or 2). The system will beep once, and then the driver's seat position, side view mirror position, steering wheel position will automatically adjust to the stored positions.
3. 'Settings 1(or 2) applied' will appear on the cluster LCD display.



### Information

- **If you press the SET button or the corresponding button which the setting is being recalled, the setting will temporarily deactivate. If you press the other buttons, the setting of the pressed button will activate.**

**For example, if you press the SET button or number 1 button with the number 1 setting in operation, the setting will temporarily deactivate. If you press the number 2 button, the number 2 setting will activate.**

- **If you adjust the seat, side view mirror, steering wheel while recalling the stored positions, the pre-set settings will become ineffective.**

## Resetting the System

Take the following procedures to reset integrated memory system, when it does not operate properly.

### ***Resetting integrated memory system***

1. Stop the vehicle and open the driver's door with the vehicle shifted to P (Park).
2. Adjust the driver's seat and seatback to the foremost position.
3. Press the SET button and push forward the driver's seat movement switch over 2 seconds simultaneously.

### ***While resetting integrated memory system***

1. Resetting starts with a notification sound.
2. The driver's seat and seatback is adjusted to the rearward position with the notification sound.
3. The driver's seat and seatback is re-adjusted to the default position (central position) with the notification sound.

However, in the following cases, the resetting procedure and the notification sound may stop.

- The memory button is pressed.
- The seat control switch is operated.
- The driving speed exceeds 2 mph (3 km/h).
- The driver's door is closed.

### **NOTICE**

- **While integrated memory system is being reset, if the resetting and notification sound stops incompletely, restart the resetting procedure again.**
- **Make sure that there are no objects around the driver's seat in advance of resetting the integrated memory system.**

### Seat Easy Access

Seat easy access will move the driver's seat and steering wheel automatically as follows:

- **Exiting the vehicle:**  
The driver's seat, steering wheel and seat bolster will move as follows when the Engine Start/Stop button is in the OFF position with the gear in P (Park) and the driver's door open.
  - Driver seat: Moves rearward depending on the distance selected from the Settings menu in the infotainment system.
  - Steering wheel: Moves upward

However, the driver's seat may not move rearward if there is not enough space between the driver's seat and the rear seats.

Also, on a regular basis, the steering wheel will also move forward to adjust its location by itself.

- **Entering the vehicle:**  
The driver's seat, steering wheel and seat bolster will move as follows when the Engine Start/Stop button is pressed to the ACC, ON or START position or while carrying the smart key, the driver's door is closed with the Engine Start/Stop button in the OFF position.
  - Driver seat: Moves back to its original position.
  - Steering wheel: Moves back to its original position.
- You can set the Seat Easy Access function from the Settings menu in the infotainment system screen. Select:
  - Driver seat  
Setup → Vehicle Settings → Seat → Seating Easy Access → Driver Seat Easy Access → Normal/Extended/Off
  - Steering wheel  
Setup → Vehicle Settings → Seat → Seating Easy Access → Steering wheel easy access

**See additional information in supplied Infotainment Manual.**

## STEERING WHEEL

### Electric Power Steering (EPS)

The system assists you with steering the vehicle. If the vehicle is turned off or if the power steering system becomes inoperative, you may still steer the vehicle, but it will require increased steering effort.

Should you notice any change in the effort required to steer during normal vehicle operation, we recommend that you have the system checked by an authorized retailer of Genesis Branded products.



#### CAUTION

If Electric Power Steering does not operate normally, the  warning light and the message 'Check motor driven power steering' will illuminate on the instrument cluster. You may steer the vehicle, but it will require increased steering efforts. We recommend that you take the vehicle to an authorized retailer of Genesis Branded products and have the system checked as soon as possible.

### Information

The following symptoms may occur during normal vehicle operation:

- **The steering effort may be high immediately after pressing the Engine Start/Stop button to the ON position.**  
This happens as the system performs the EPS system diagnostics. When the diagnostics is completed, the steering wheel effort will return to its normal condition.
- **When the battery voltage is low, you may have to put more steering effort. However, it is a temporary condition so that it will return to normal condition after charging the battery.**
- **A click noise may be heard from the EPS relay after the Engine Start/Stop button is in the ON or OFF position.**
- **Motor noise may be heard when the vehicle is at a stop or at a low driving speed.**
- **When you operate the steering wheel in low temperatures, abnormal noise may occur. If the temperature rises, the noise will disappear.**  
This is a normal condition.
- **When an error is detected from EPS, the steering effort assist function will not be activated in order to prevent accidents. Instrument cluster warning lights may be on or the steering effort may be high. If these symptoms occur, drive the vehicle to a safe area as soon as it is safe to do so. Have the system checked by an authorized retailer of Genesis Branded products as soon as possible.**

## Tilt/Telescopic Steering

When adjusting the steering wheel to a comfortable position, adjust the steering wheel so that it points toward your chest, not toward your face. Make sure you can see the instrument cluster warning lights and gauges. After adjusting, push the steering wheel both up and down to be certain it is locked in position.

Always adjust the position of the steering wheel before driving.

### **WARNING**

**NEVER** adjust the steering wheel while driving. This may cause loss of vehicle control resulting in an accident.

### Manual adjustment

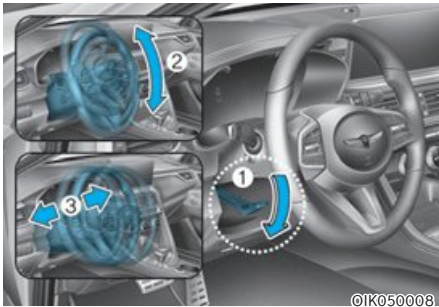

To adjust the steering wheel angle and height:

1. Pull down the lock-release lever (1).
2. Adjust the steering wheel to the desired angle (2) and distance forward/back (3).
3. Pull up the lock-release lever to lock the steering wheel in place.

### **Information**

Sometimes the lock release lever may not engage completely. This may occur when the gears of the locking mechanism do not completely mesh. If this occurs, pull down on the lock-release lever, readjust the steering wheel again, and then pull back up on the release lever to lock the steering wheel in place.

### Power adjustment

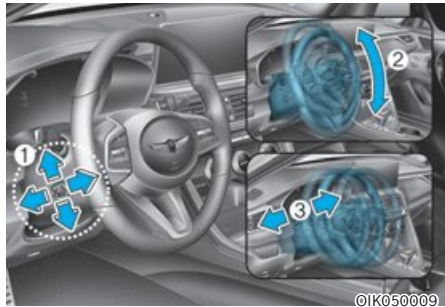

To change the steering wheel angle and height:

- Push the switch (1) up and down to adjust the angle (2).
- Push the switch forward or rearward to adjust the height (3).

### **NOTICE**

**Do not adjust the steering wheel longer than necessary when the engine is turned off. This may result in unnecessary battery drain.**

### Resetting steering wheel power adjustment

If adjustment is no longer possible within the operable range while adjusting the steering wheel position (angle or height), reset as follows.

1. From the position the steering wheel has stopped, push the control switch (1) for 10 seconds in the direction you were adjusting the steering wheel. The steering wheel will move in the direction the control switch is pushed.
2. Continue pushing the switch (1) for at least 2 seconds after the steering wheel has stopped. Resetting will be complete after the operational range is recognized.

If the adjustment is still not possible after resetting the steering wheel power adjustment, we recommend that the system be inspected by an authorized retailer of Genesis Branded products.

### Horn



To sound the horn, press the area indicated by the horn symbol on your steering wheel (see illustration). The horn will operate only when this area is pressed.

### **NOTICE**

**Do not strike the horn severely, or hit it with your fist. Do not press on the horn with a sharp-pointed object.**

## Heated Steering Wheel (if equipped)

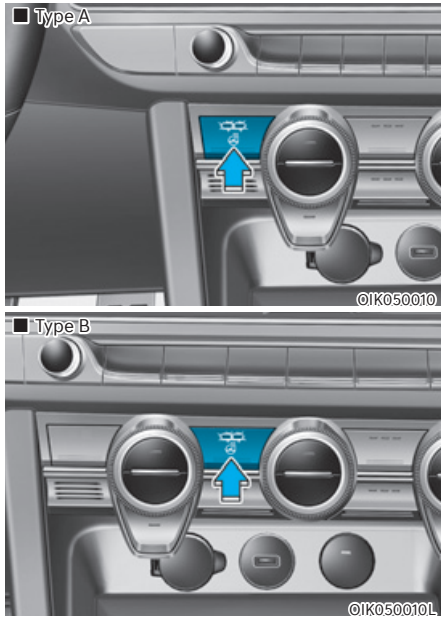

When the Engine Start/Stop button is in the ON position or when the engine is running, press the heated steering wheel button to warm the steering wheel. The indicator on the button will illuminate.

To turn the heated steering wheel off, press the button again. The indicator on the button will turn off.

- Each time you push the switch, the temperature setting changes as follows:



- When the heated steering wheel switch is pressed to high (steering wheel icon with 10 heat rays):  
The heated steering wheel switch automatically changes to the low position after 30 minutes. You can turn off the heated steering wheel by pressing the switch to the OFF position.
- When the Engine Start/Stop button is pressed to the ON position with the heated steering wheel switch in the high/low position, the heated steering wheel automatically starts in the high position.
- When the Engine Start/Stop button is pressed to the ON position with the heated steering wheel OFF, the heated steering wheel will stay OFF.

### NOTICE

**Do not install any cover or accessory on the steering wheel. This cover or accessory could cause damage to the heated steering wheel system.**

## MIRRORS

### Inside Rearview Mirror

Before driving your vehicle, check to see that your inside rearview mirror is properly positioned. Adjust the rearview mirror so that the view through the rear window is properly centered.



#### WARNING

**Make sure your line of sight is not obstructed. Do not place objects in the rear seat, cargo area, or behind the rear headrests which could interfere with your vision through the rear window.**



#### WARNING

**To prevent serious injury during an accident or deployment of the air bag, do not modify the rearview mirror and do not install a wide mirror.**



#### WARNING

**NEVER adjust the mirror while driving. This may cause loss of vehicle control resulting in an accident.**

#### NOTICE

**When cleaning the mirror, use a paper towel or similar material dampened with glass cleaner. Do not spray glass cleaner directly on the mirror as this may cause the liquid cleaner to enter the mirror housing.**

### Electrochromic Mirror (ECM)



[A] : Indicator

Some vehicles come equipped with an electrochromic mirror that helps control glare while driving at night or under low light driving conditions.

When the engine is running, the glare is automatically controlled by the sensor mounted in the rearview mirror. The sensor detects the light level around the vehicle, and automatically adjusts to control the headlamp glare from vehicles behind you.

Whenever the the gear is shifted to R (Reverse), the mirror will automatically go to the brightest setting in order to improve the driver's view behind the vehicle.



### **Electrochromic mirror (ECM) with HomeLink® system and Genesis Connected Service (if equipped)**

Your vehicle may be equipped with a Gentex Automatic-Dimming Mirror with an Integrated HomeLink® Wireless Control System.

During nighttime driving, this feature will automatically detect and help reduce rearview mirror glare. The HomeLink® Universal Transceiver allows you to activate your garage door(s), electric gate, home lighting, etc.

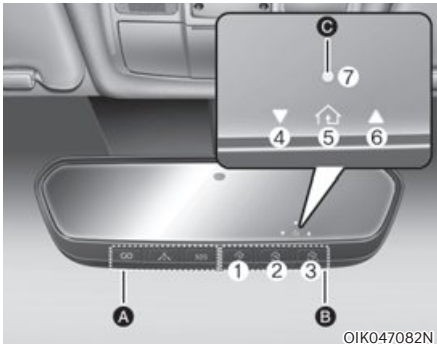

[A] : Telematics buttons, [B] : HomeLink buttons,  
[C] : HomeLink indicator

- (1) HomeLink Channel 1
- (2) HomeLink Channel 2
- (3) HomeLink Channel 3
- (4) Garage Door Opener Status Indicator : Closing or Closed
- (5) HomeLink Operation Indicator
- (6) Garage Door Opener Status Indicator : Opening or Opened
- (7) HomeLink User Interface Indicator

### **Automatic-Dimming Night Vision Safety™ (NVS®) Mirror (if equipped)**

The NVS® Mirror automatically helps reduce glare by monitoring light levels in the front and the rear of the vehicle. Any object that obstructs either light sensor will degrade the automatic dimming control feature.

**For more information regarding NVS® mirrors and other applications, please refer to the Gentex website:**

**[www.gentex.com](http://www.gentex.com)**

Your mirror will automatically dim upon detecting glare from the vehicles traveling behind you.

The mirror defaults to the ON position each time the vehicle is started.

### **Integrated HomeLink® Wireless Control System**

The HomeLink® Wireless Control System provides a convenient way to replace up to three hand held radio-frequency transmitters used to activate compatible devices such as gate operators, garage door openers, entry door locks, security systems, and home lighting.

### **NOTICE**

**HomeLink® operates while the ignition switch is in the ACC or ON position for safety reasons. It is to prevent unintentional security problems from happening when the vehicle is parked outside the garage.**



## WARNING

Before programming HomeLink® to a garage door opener or gate operator, make sure people and objects are out of the way of the device to prevent potential harm or damage. Do not use the HomeLink® with any garage door opener that lacks the safety stop and reverse features required by U.S. federal safety standards (this includes any garage door opener model manufactured before April 1, 1982). A garage door that cannot detect an object - signaling the door to stop and reverse - does not meet current U.S. federal safety standards. Using a garage door opener without these features increases the risk of serious injury or death.

For more information, contact HomeLink® at [www.homelink.com](http://www.homelink.com), or call Home-Link customer support at 1-800-355-3515.

It is also recommended that a new battery be replaced in the handheld transmitter of the device being trained to HomeLink® for quicker training and accurate transmission of the radio frequency.

### 1. Programming HomeLink®

The following steps show how to program HomeLink. If you have any questions or are having difficulty programming your HomeLink buttons, refer to the HomeLink website or call the HomeLink customer support toll-free number. Do this, before going back to the dealer who sold you the car.

- Visit the HomeLink website at: [www.homelink.com](http://www.homelink.com). Then at the top of the page, choose your vehicle make. Then watch the You Tube video, and/or access additional website information.
- If you choose to access the website via your cell phone, scan the QR code.



- Or, call HomeLink customer support at 1-800-355-3515 (Please have the vehicle make/model AND the opener device make/model readily available.)

### 1) Programming Preparation

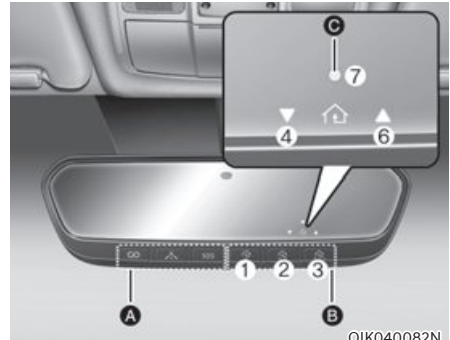

1. When programming a garage door opener, it is advised to park the vehicle outside of the garage.
2. It is recommended that a new battery be placed in the handheld transmitter of the device being programmed to HomeLink for quicker training and accurate transmission of the radio-frequency signal.
3. Place the ignition switch to the ACC (Accessory) position for programming of HomeLink.

## 2) Programming a New HomeLink®



1. Press and release the HomeLink button (1), (2) or (3), you would like to program. The HomeLink indicator light (7) will flash orange slowly (if not, perform the steps of “Erasing HomeLink Buttons” section, and start over).



2. Position the garage door opener remote 1 – 3 inches (2 – 8cm) away from the HomeLink buttons.

3. While the HomeLink indicator light (7) is flashing orange, press and hold the hand-held remote button. Continue pressing the handheld remote button until the HomeLink indicator light (7) light changes from orange to green. You may now release the handheld remote button.

4. Wait until your garage door comes to a complete stop, regardless of position, before proceeding to the next steps.
5. Press and release the HomeLink button you are programming and observe the indicator light.
  - If the indicator light remains solid green, your device should operate when the HomeLink button is pressed. At this point, if your device operates, programming is complete.
  - If the indicator light rapidly flashes green, firmly press, hold for two seconds and release the HomeLink button up to three times in a row slowly to complete the programming process. Do not press the HomeLink button rapidly. At this point if your device operates, programming is complete. If the device does not operate, continue with step 6.
6. At the garage door opener motor, (security gate motor, etc.) locate the "Learn", "Smart", "Set" or "Program" button. This can usually be found where the hanging antenna wire is attached to the motor-head unit (see the device's manual to identify this button). The name and color of the button may vary by manufacturer.

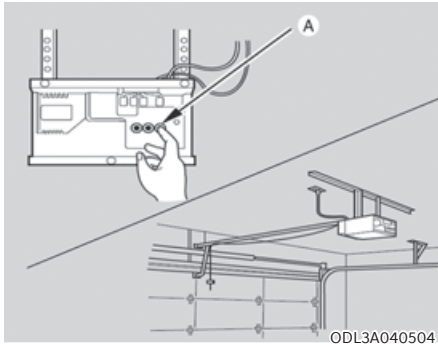

- \* A ladder and/or second person may simplify the following steps.
7. Firmly press and release the "Learn", "Smart", "Set" or "Program" button. You now have up to 30 seconds in which to complete the next step.
  8. Return to the vehicle and firmly press, hold for two seconds and release, the HomeLink button up to three times in a row slowly. Do not press the HomeLink button rapidly. As soon as you see the garage door start to move, stop pressing any buttons until a few seconds after the garage door has come to a complete stop, regardless of position. At this point, programming is complete and your device should operate when the HomeLink button is pressed and released.

### 3) Two-Way Communication Programming (For select garage door openers)

If your garage door opener has the 'myQ' logo on its side, your opener likely has Two-Way Communication capability. HomeLink has the capability to establish Two-Way Communication with your garage door opener. HomeLink can receive and display "closing" or "opening" status messages from compatible garage door openers. At any time, Home-Link can also recall and display the last recorded status communicated by the garage door opener to indicate your garage door being "closed" or "opened".

To check if your garage door opener is compatible with this feature, refer to [www.homelink.com/compatible/](http://www.homelink.com/compatible/) Two-way-Communication. If your garage door opener has this functionality, AND the Two-Way Communication indicators (4), (6) in the mirror appear while the garage door is opening/closing, then no further steps are needed. Two-Way Communication Programming is already complete.

However, if your garage door opener has this functionality, AND the Two-Way Communication indicators (4), (6) in the mirror DO NOT appear while the garage door is opening/closing, use the following instructions to enable this functionality.

1. In your vehicle, press and hold the programmed HomeLink button for 2 seconds, then release. Confirm that the garage door is moving. AFTER it stops, you will have one minute to complete the following steps:
  - \* A ladder and/or second person may simplify the following steps.
2. On your garage door opener in your garage, locate the "Learn" button (usually near where the hanging antenna wire is attached to the garage door opener). If there is difficulty locating this button, reference the device's owner's manual.
3. Press and release the "Learn" button.
4. A light on your garage door opener may flash, and your Two-Way Communication indicators (4), (6) in your vehicle may flash, confirming completion of the process.
5. Return to the vehicle and firmly press and release the programmed HomeLink button to activate your garage door. The Two-Way Communication indicators (4), (6) flash in orange when the door is moving. Do not make any additional button presses until AFTER the garage door has come to a complete stop.
6. Your Two-Way Communication programming is now complete.

### Information

**If your garage door opener has Two-Way Communication functionality, it is possible for HomeLink to stop functioning the garage door shortly after initial programming, IF the Two-Way Communication Programming wasn't properly completed. This usually happens after the first 10 times a programmed HomeLink button is pressed. If you experience this, completing the "Programming a New HomeLink Button" and "Two-Way Communication Programming" will restore door operation.**

### 4) Canadian Programming

Canadian radio-frequency laws require transmitter remote signals to "time-out" (or quit) after a couple seconds of transmission, which may not be long enough for HomeLink to pick up the signal during programming.

If you live in Canada or you are having difficulties programming a gate operator or garage door opener by using the programming procedures, replace "Programming a New HomeLink Button" step 3 with the following:

While the HomeLink indicator light (7) is flashing orange, press and release ("cycle") your device's handheld remote every two seconds until the HomeLink indicator light (7) changes from orange to green. You may now release the hand-held remote button. Then proceed with "Programming a New HomeLink Button" step 4.

### 2. Operating HomeLink®

#### 1) Operating HomeLink®

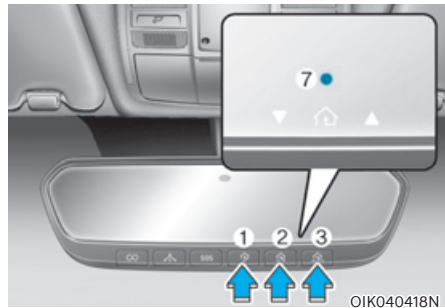

1. Press and release the desired programmed HomeLink button (1, 2 or 3).

## **i** Information

The HomeLink indicator (7) should light green, solid or flashing, and your programmed device should operate.

If your device does not operate, the HomeLink programming was not successful, and you'll need to reprogram the button.

### 2) Two-Way Communication Display Behavior



1. Press and release one of the programmed HomeLink buttons (1, 2 or 3).

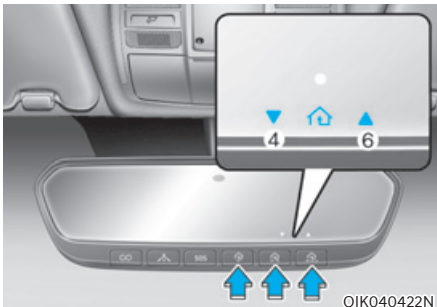

2. The indicator (4) and (6) operates as below, if your garage door opener has Two-Way Communication functionality.

- If the indicator (4) flashes in Orange, it indicates that the garage door is "Closing".
- The indicator (4) turns solid green once the garage door has closed.
- If the indicator (6) flashes in Orange, it indicates that the garage door is "Opening".
- The indicator (6) turns solid green once the garage door has fully opened.
- If the indicator (4) or (6) does not turn to green, it indicates that the last status of garage door was not received properly. The HomeLink mirror tries to receive the last known status of the garage door for a few seconds.

### 3) Recalling Garage Door Status

HomeLink mirror with Two-Way Communication provides a way to view the last stored message from the garage door opener. In order to recall the last known status of the last activated device, press the buttons "1 and 2" OR "2 and 3" simultaneously.

- If the indicator (4) appears solid Green, it indicates that the last activated device was "closed" properly.
- If the indicator (6) appears solid Green, it indicates that the last activated device was "open" properly.

### 3. Erasing HomeLink® Buttons

#### 1) Erasing and Reprogramming a Single HomeLink® Button:

1. Press and hold the desired HomeLink button you want to re-program. DO NOT release the button.
2. The HomeLink indicator light (7) will illuminate solid green. Release the button as soon as the HomeLink indicator light (7) begins to flash orange, usually about 20 seconds.
3. Proceed with the steps in the "Programming a New HomeLink Button" section.

#### **i** Information

**If you do not complete the re-programming of a new device to the button, it will revert to the previously stored programming.**

#### 2) The following instructions will erase ALL HomeLink® programming from ALL buttons:

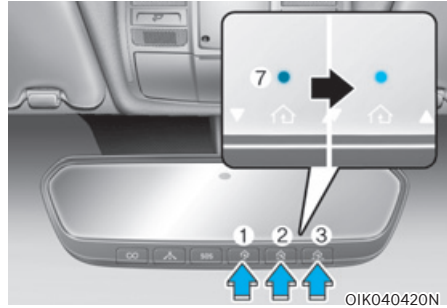

1. Press and hold the buttons (1) and (3) simultaneously
2. The HomeLink indicator light (7) will illuminate solid Orange for about 10 seconds
3. Release the buttons once the HomeLink indicator light (7) changes to Green and flashes rapidly
4. Now all three HomeLink buttons (1), (2) and (3) are cleared of any programming

#### **i** Information

**HomeLink® and the HomeLink® House logo are registered trademarks of Gentex Corporation.**

**The myQ logo is a registered trademark of The Chamberlain Group, Inc.**

**FCC (USA) and ISED (Canada)**

This device complies with FCC rules part 15 and Innovation, Science, and Economic Development Canada RSS-210. Operation is subject to the following two conditions: (1) This device may not cause harmful interference, and (2) This device must accept any interference that may be received including interference that may cause undesired operation. **WARNING:** The transmitter has been tested and complies with FCC and ISED rules. Changes or modifications not expressly approved by the party responsible for compliance could void the user's authority to operate the device.

This equipment complies with FCC and ISED radiation exposure limits set forth for an uncontrolled environment. End Users must follow the specific operating instructions for satisfying RF exposure compliance. This transmitter must be at least 20cm from the user and must not be co-located or operating in conjunction with any other antenna or transmitter.

**FCC (Etats-Unis) et ISED (Canada)**

Cet appareil est conforme aux règlements de la FCC, section 15, et au CNR-210 d'Innovation, Sciences et Développement économique Canada. Le fonctionnement est assujéti aux deux conditions suivantes : (1) cet appareil ne doit pas causer d'interférences nuisibles et (2) cet appareil doit accepter toute interférence reçue, y compris celle qui pourrait entraîner un dysfonctionnement. **MISE EN GARDE :** L'émetteur a subi des tests et est conforme aux règlements de la FCC et d'ISDE. Les changements ou modifications non approuvés explicitement par la partie responsable de la conformité pourraient rendre caduque l'autorisation de l'utilisateur de se servir du dispositif.

Cet appareil est conforme aux limites d'exposition aux radiations de la FCC et d'ISDE établies pour un environnement non contrôlé. Les utilisateurs finaux doivent respecter les instructions d'utilisation spécifiques pour satisfaire aux exigences de conformité aux expositions de RF. L'émetteur doit se trouver à 20 cm au minimum de l'utilisateur et ne doit pas être situé au même endroit que tout autre émetteur ou antenne ni fonctionner avec un autre émetteur ou antenne.

**Méjico**

La operación de este equipo está sujeta a las siguientes dos condiciones: (1) es posible que este equipo o dispositivo pueda no causar interferencia dañina, y (2) este dispositivo o dispositivos deben aceptar cualquier interferencia, que incluye la interferencia que puede causar su operación no deseada.



### HomeLink 5 Proaming Flow Chart

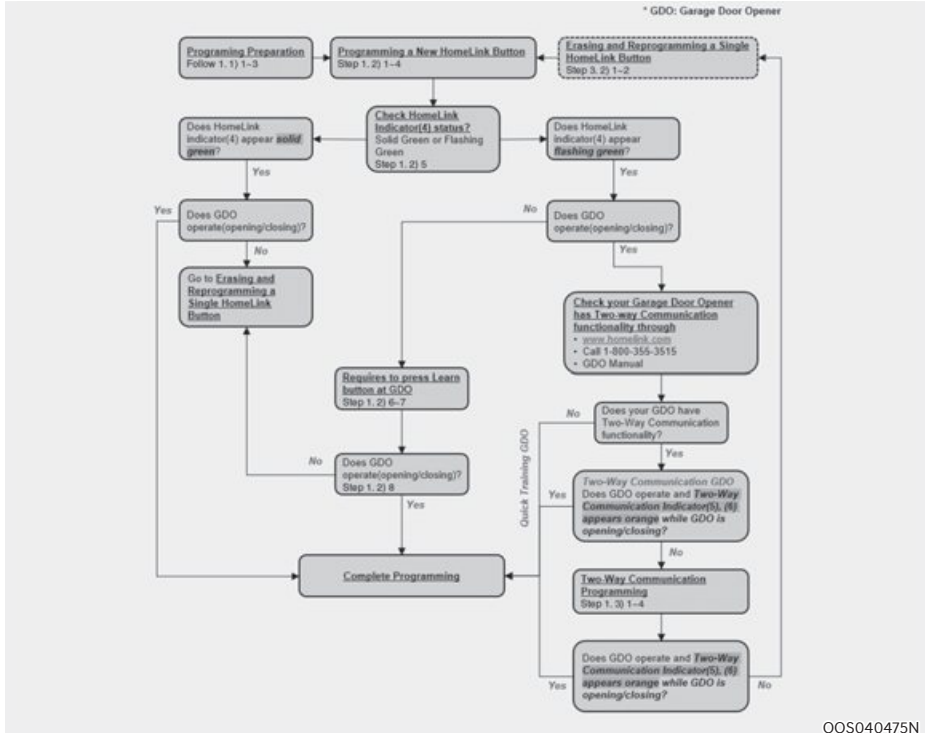

## Side View Mirrors

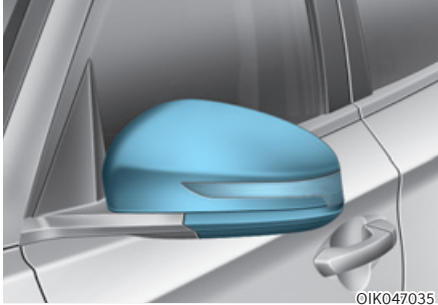

Your vehicle is equipped with both left-hand and right-hand side view mirrors. The mirrors can be adjusted remotely with the mirror adjustment control switch. The side view mirrors can be folded to help prevent damage when going through an automatic car wash or when passing through a narrow street.

The right side view mirror is convex. Objects seen in the mirror are closer than they appear.

Use the inside rear view mirror or look back directly to determine the actual distance of other vehicles prior to changing lanes.

Make sure to adjust the side view mirrors to your desired position before you begin driving.



### WARNING

Do not adjust or fold the side view mirrors while driving. This may cause loss of vehicle control resulting in an accident.

### NOTICE

- Do not scrape ice off the mirror face; this may damage the surface of the glass.
- If the mirror is jammed with ice, do not adjust the mirror by force. Use an approved spray de-icer (not radiator antifreeze) spray, or a sponge or soft cloth with very warm water, or move the vehicle to a warm place and allow the ice to melt.
- Do not clean the mirror with harsh abrasives, fuel or other petroleum based cleaning products.

### Adjusting the side view mirrors

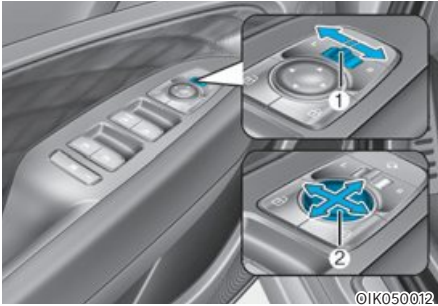

1. Move the lever (1) either to the L (left side) or R (right side) to select the side view mirrors you would like to adjust.
2. Use the side view mirrors adjustment control (2) to position the selected mirror up, down, left or right.
3. After adjustment, move the lever (1) to the middle to prevent inadvertent adjustment.

#### **NOTICE**

- **The side view mirrors stop moving when they reach the maximum adjusting angles, but the motor continues to operate while the switch is pressed. Do not press the switch longer than necessary, because this can damage the motor.**
- **Do not attempt to adjust the side view mirrors by hand, because this can damage the motor.**

### Folding the side view mirrors

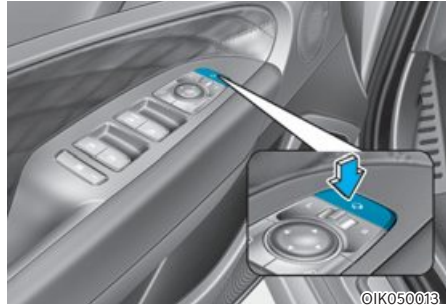

#### **Folding button**

The side view mirrors can be folded or unfolded by pressing the button.

#### **Infotainment system setting**

- Enable on door unlock  
If 'Setup → Vehicle Settings → Convenience → Welcome Mirror/Light → Enable on Door Unlock' is selected from the Settings menu in the infotainment system screen,
  - The mirror will fold or unfold when the door is locked or unlocked by the smart key.
  - The mirror will fold or unfold when the door is locked or unlocked by the touch sensor on the outside door handle.
- Enable on driver approach  
If 'Setup → Vehicle Settings → Convenience → Welcome Mirror/Light → Enable on Driver Approach' is selected from the Settings menu in the infotainment system screen, the mirror will unfold when the vehicle is approached with the smart key in possession.

**See additional information in supplied Infotainment Manual.**

**NOTICE**

The electric type side view mirror operates even though the Engine Start/Stop button is in the OFF position. However, to prevent unnecessary battery discharge, do not adjust the mirrors longer than necessary while the engine is not running.

**NOTICE**

Do not fold the electric type side view mirror by hand. It could cause motor failure.

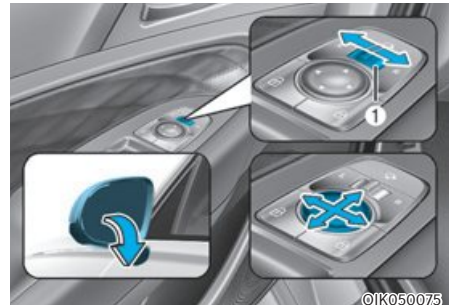
**Reverse Parking Aid (if equipped)**

When the gear is shifted to the R (Reverse) position, the side view mirrors will rotate downwards to aid with driving in reverse.

The state of the side view mirrors switch (1) determines whether or not the mirrors will move:

How it works

**Left/Right :** When either the L (Left) or R (Right) side is selected, both side view mirrors will move.

**Neutral :** When neither side is selected, the side view mirrors will not move.

The side view mirrors will automatically revert to their original positions if any of the following occurs:

- The Engine Start/Stop button is pressed to either the OFF position or the ACC position.
- The gear is shifted to any position except R (Reverse).
- The side view mirrors adjustment switch is not selected.

### ***Reverse parking aid user settings mode***

You may change the angle of the side view mirrors if it is difficult to see the rear view with the basic downward mirror angle provided when reversing.

When the vehicle is first delivered, the set downward angle of the left and right side view mirrors are different to ensure driver visibility.

1. Make sure the vehicle is stopped.
2. Depress the brake pedal and shift the gear to R (Reverse). When L (Left) or R (Right) side is selected, both side view mirrors angle will move downward to the basic set position.
3. Move the lever either to L or R to select the side view mirrors you would like to adjust. Then press “▼, ▲, ◀, ▶” switch to adjust the side view mirrors to the desired angle.
4. After adjusting the angle to save the adjusted side view mirrors angle, shift the gear to another position other than R (Reverse), or change the L and R lever to the neutral position (locate the lever in the middle of L and R).
5. Set the side view mirrors following the above procedure 1 to 4.

### **Resetting reverse parking aid user settings mode**

To change the side view mirrors angle back to the basic angle, shift the gear to R (Reverse), and adjust the mirror angle higher than when the gear is in P (Park), N (Neutral) and D (Drive).

### **NOTICE**

**When changing the angle of both side view mirrors, it is recommended to change the angle one side at a time following the procedure 1 to 4.**

## WINDOWS

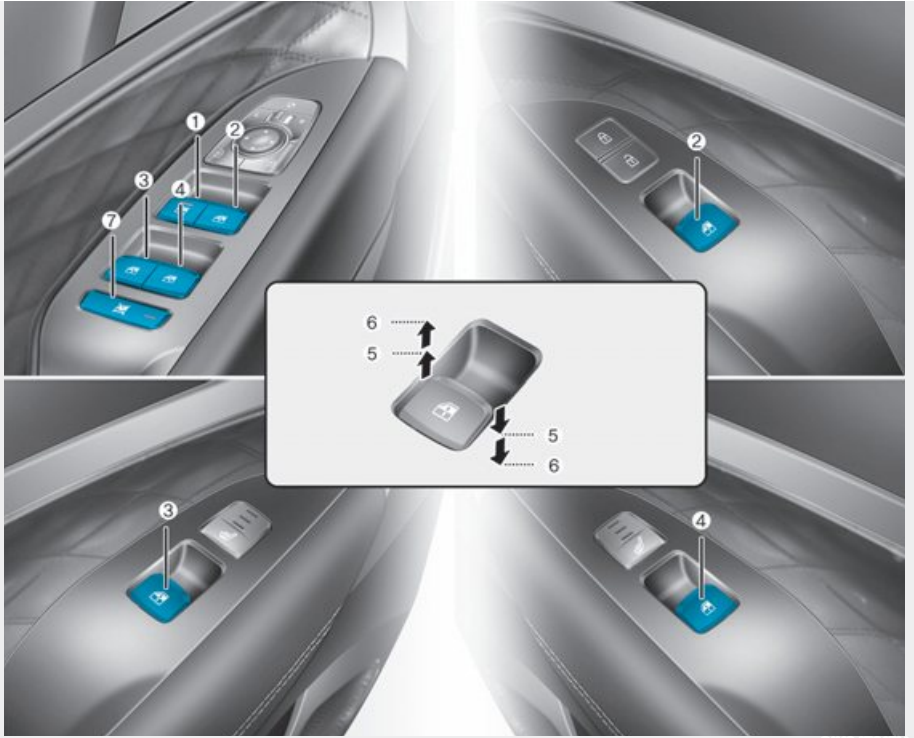

OIK047015N

- |  |   |
|--|---|
| (1) Driver's door power window switch          | (4) Rear door (right) power window switch |
| (2) Front passenger's door power window switch | (5) Window opening and closing            |
| (3) Rear door (left) power window switch       | (6) Automatic power window                |
|  | (7) Power window lock switch              |

## Power Windows

The Engine Start/Stop button must be in the ON position to be able to raise or lower the windows. Each door has a Power Window switch to control that door's window. The driver has a Power Window Lock button which can block the operation of passenger windows. The power windows will operate for approximately 30 seconds after the Engine Start/Stop button is in the ACC or OFF position. However, if the front doors are opened, the Power Windows will not operate even within the 30 seconds period.

### **WARNING**

**To avoid serious injury or death, do not extend your head, arms or body outside the windows while driving.**

### **Information**

- **In cold and wet climates, power windows may not work properly due to freezing conditions.**
- **While driving with the rear windows down or with the sunroof (if equipped) opened (or partially opened), your vehicle may demonstrate a wind buffeting or pulsation noise. This noise is normal and can be reduced or eliminated by taking the following actions. If the noise occurs with one or both of the rear windows down, partially lower both front windows approximately one inch. If you experience the noise with the sunroof open, slightly close the sunroof.**

## Window opening and closing

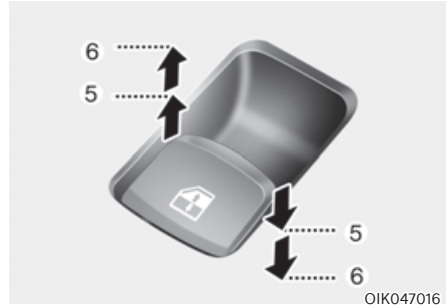

To open:

Press the window switch down to the first detent position (5). Release the switch when you want the window to stop.

To close:

Pull the window switch up to the first detent position (5). Release the window switch when you want the window to stop.

### Auto up/down window

Pressing or pulling up the power window switch momentarily to the second detent position (6) completely lowers or lifts the window even when the switch is released. To stop the window at the desired position while the window is in operation, pull up or press down and release the switch.

### Resetting the power windows

If the power windows do not operate normally, the automatic power window system must be reset as follows:

1. Press the Engine Start/Stop button to the ON position.
2. Close the window and continue pulling up on the power window switch for at least one second.

If the power windows do not operate properly after resetting, have the system be inspected by an authorized retailer of Genesis Branded products.

### Automatic reverse

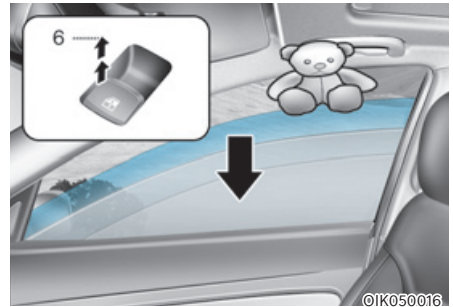

If a window senses any obstacle while it is closing automatically, it will stop and lower approximately 12 in. (30 cm) to allow the object to be cleared.

If the window detects the resistance while the power window switch is pulled up continuously, the window will stop upward movement then lower approximately 1 in. (2.5 cm).

If the power window switch is pulled up continuously again within 5 seconds after the window is lowered by the automatic window reverse feature, the automatic window reverse will not operate.

### **i** Information

The automatic reverse feature is only active when the “Auto Up” feature is used by fully pulling up the switch to the second detent.

### **!** WARNING

Make sure body parts or other objects are safely out of the way before closing the windows to avoid injuries or vehicle damage.

Objects less than 0.16 in. (4 mm) in diameter caught between the window glass and the upper window channel may not be detected by the automatic reverse window and the window will not stop and reverse direction.



### Power window lock button

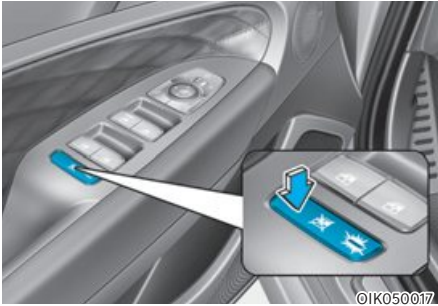

The driver can disable the power window switches on the rear passenger doors by pressing the power window lock button. When the power window lock button is pressed:

- The rear passenger control will not be able to operate the rear passenger power window
- Note that the front passenger control is still able to operate the front passenger window, and that the driver master control can still operate all the power windows.

### **WARNING**

Do not allow children to play with the power windows. Keep the driver's door power window lock button in the LOCK position. Serious injury or death can result from unintentional window operation by a child.

### **NOTICE**

- To prevent possible damage to the power window system, do not open or close two windows or more at the same time. This will also ensure the longevity of the fuse.
- Never try to operate the main switch on the driver's door and the individual door window switch in opposite directions at the same time. If this is done, the window will stop and cannot be opened or closed.

### **WARNING**

- **NEVER** leave the keys in your vehicle with unsupervised children, when the engine is running.
- **NEVER** leave any child unattended in the vehicle. Even very young children may inadvertently cause the vehicle to move, entangle themselves in the windows, or otherwise injure themselves or others.
- Always double check to make sure all arms, hands, head and other obstructions are safely out of the way before closing a window.
- Do not allow children to play with the power windows. Keep the driver's door power window lock switch in the LOCK position (pressed). Serious injury can result from unintentional window operation by the child.
- Do not extend your head, arms or body outside the windows while driving.

## Remote Window Opening Function (if equipped)



OIK050247N

You can still control the window movement with the engine turned off.

- Press the Door Unlock button for more than 3 seconds. The window moves down after the doors are unlocked, as long as you press the door unlock button. The window movement stops, when you release the door lock button.

## **i** Information

- The remote window opening function may abruptly stop, when you move away from your vehicle during operation. Stay in close proximity from your vehicle, while monitoring the window movement.
- One of the windows may stop operating, when the window is interrupted by certain force. However, the other windows will keep operating. Thus, you should make sure that all windows are closed.
- Please be aware that the doors unlock when the windows are opened using the remote window opening function.

## WIDE SUNROOF (IF EQUIPPED)

If your vehicle is equipped with a sunroof, you can slide or tilt your sunroof with the sunroof switch located on the overhead console.



The sunroof can only be operated when the Engine Start/Stop button is in the ON or START position.

The sunroof can be operated for approximately 30 seconds after the Engine Start/Stop button is in the ACC or OFF position. However, if the front door is open, the sunroof cannot be operated even within the 30 second period.

### **WARNING**

- **Never adjust the sunroof or sunshade while driving. This could result in loss of control and an accident that may cause injury, or property damage.**
- **Do not leave the engine running and the key in your vehicle with unsupervised children. Unattended children could operate the sunroof, which could result in serious injury.**
- **Do not sit on the top of the vehicle. It may cause injury or vehicle damage.**

### **NOTICE**

**Do not operate the sunroof when the roof bars are installed on the vehicle or when there is luggage on the roof.**

## Power sunblind



Use the power sunshade to block direct sunlight coming through the sunroof glass.

- Push the sunroof switch rearward to the first detent position, the sunshade will automatically slide open.
- Push the sunroof switch forward to the first detent position, the sunshade will automatically close. However, if the sunroof glass is open, the glass will close first.

To stop the sunshade at any point, push the sunroof switch in any direction.

### NOTICE

**Do not pull or push the power sunshade by hand as such action may damage the sunshade or cause it to malfunction.**



### WARNING

**Wrinkles formed on the power sunshades are normal due to material characteristic.**

## Tilt open/close

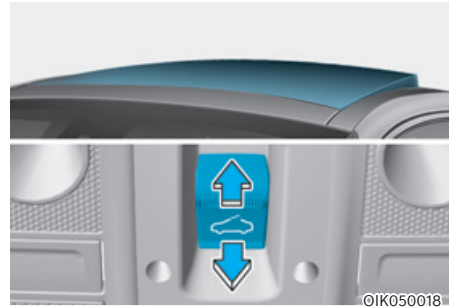

- Push the sunroof switch upward, the sunroof glass will tilt open. However, if the power sunshade is close, the sunshade will open first.
- Push the sunroof switch forward, the sunroof glass will automatically close.

To stop the sunroof movement at any point, push the sunroof switch in any direction.

### Slide open/close

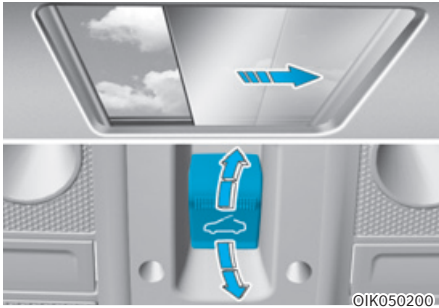

- Push the sunroof switch rearward, the sunroof glass will slide open. However, if the power sunshade is close, the sunshade will open first. Push the sunroof switch forward, the sunroof glass will close.
- Push the sunroof switch forward to the first detent position, the sunroof glass will operate manually. Push the sunroof switch forward to the second detent position, the sunroof glass will operate automatically (auto slide feature). To stop the sunroof movement at any point, push the sunroof switch in any direction.

### Automatic reversal

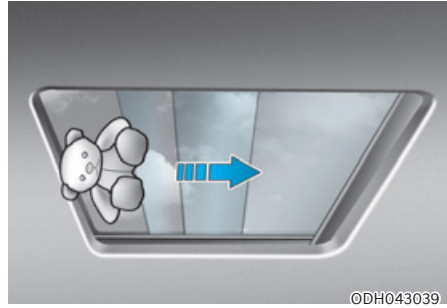

If the sunroof senses any obstacle while it is closing automatically, it will reverse direction then stop at a certain position. The auto reverse function may not work if an object thin or soft is caught, or the sunroof is closed manually.

#### **WARNING**

- **Make sure heads, hands, arms or any other body parts or objects are out of the way before operating the sunroof. Body parts or objects may get caught causing injuries or vehicle damage.**
- **Never deliberately use your body parts to test the automatic reversal function. The sunroof glass may reverse direction, but there is a risk of injury.**

**NOTICE**

- **Do not continue to push the sunroof switch after the sunroof is fully opened, closed, or tilted. Damage to the sunroof motor could occur.**
- **Continuous operations such as slide open/close, tilt open/close, etc. may cause the motor or sunroof system to malfunction.**
- **Regularly remove any accumulated dust on the sunroof rail.**
- **Using the sunroof for a long time can make noise caused by dust in accumulated between the sunroof and vehicle body. Open the sunroof and remove dust regularly using a clean cloth.**
- **Do not try to open the sunroof when the temperature is below freezing or when the sunroof is covered with snow or ice, otherwise the motor could be damaged. In cold and wet climates, the sunroof may not work properly.**
- **Do not open or drive with the sunroof glass open immediately after rain or washing the vehicle. Water may wet the interior of the vehicle.**
- **Do not extend any luggage outside the sunroof while driving. Vehicle damage may occur if the vehicle suddenly stops.**

**WARNING**

**Do not extend your head, arms, body parts or objects outside the sunroof while driving. Injuries may occur if the vehicle suddenly stops.**

**Resetting the sunroof**

In some circumstances resetting the sunroof operation may need to be performed. Some instances where resetting the sunroof may be required include:

- When the 12 volt battery is either disconnected or discharged
- When the sunroof fuse is replaced
- If the sunroof one-touch AUTO OPEN/CLOSE operation is not functioning properly

Sunroof resetting procedure:

1. It is recommended to perform the reset procedure with the vehicle engine running. Start the vehicle in P (Park).
2. Make sure the sunshade and sunroof glass is in the fully closed position. If the sunshade and sunroof glass is open, push the switch forward until the sunshade and sunroof glass is fully closed.
3. Release the switch when the sunshade and sunroof glass is fully closed.
4. Push the switch forward until the sunshade and sunroof glass moves slightly. Then release the switch.
5. Within 3 seconds, push and hold the sunroof switch forward until the sunshade and sunroof glass slides open and close. Do not release the switch until the operation is completed. If you release the switch during operation, start the procedure again from step 2.

**Information**

**If the sunroof is not reset when the vehicle battery is disconnected or discharged, or the sunroof fuse is blown, the sunroof may not operate normally.**

## Sunroof Open Warning

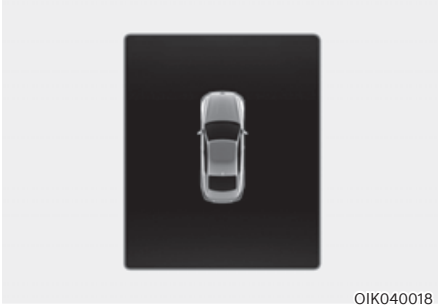

If the driver turns off the engine when the sunroof is not fully closed, the warning chime will sound for several seconds and the sunroof open warning will appear on the cluster LCD display.

Close the sunroof securely when leaving your vehicle.



### **CAUTION**

**Make sure the sunroof is closed fully when leaving your vehicle.**

**If the sunroof is left open, rain or snow may wet the interior of the vehicle.**

**Also, leaving the sunroof open when the vehicle is unattended may invite theft.**

## EXTERIOR FEATURES

### Hood

#### Opening the hood



1. Park the vehicle and set the parking brake.
2. Pull the release lever to unlatch the hood. The hood should pop open slightly.

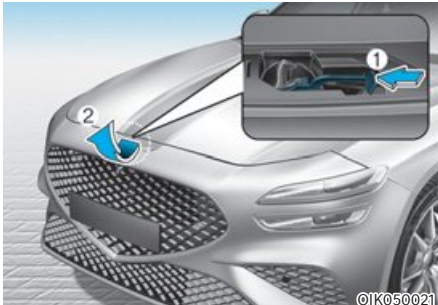

3. Go to the front of the vehicle, raise the hood slightly, push up the secondary latch (1) inside of the hood center and lift the hood (2).

After the hood has been lifted halfway, it will raise completely by itself.

#### Closing the hood

1. Before closing the hood, check in and around the engine compartment to ensure the following:
  - Any tools or other loose objects are removed from the engine room area or hood opening area
  - All glove, rags, or other combustible materials is removed from the engine compartment
  - All filler caps are tightly and correctly installed
2. Lower the hood halfway (lifted approximately 12 in. (30 cm) from the closed position) and push down to securely lock in place. Then double check to be sure the hood is secure. If the hood can be raised slightly, it is not securely locked. Open it again and close it with more force.

#### WARNING

- Before closing the hood, ensure all obstructions are removed from around the hood opening.
- Always double check to be sure that the hood is firmly latched before driving away. Check there is no hood open warning light or message displayed on the instrument cluster. Driving with the hood opened may cause a total loss of visibility, which might result in an accident.
- Do not move the vehicle with the hood in the raised position, as vision is obstructed, which might result in an accident, and the hood could fall or be damaged.



## Trunk (if equipped)

### Opening the trunk

1. Make sure the vehicle is shifted to P (Park) and engage the parking brake.

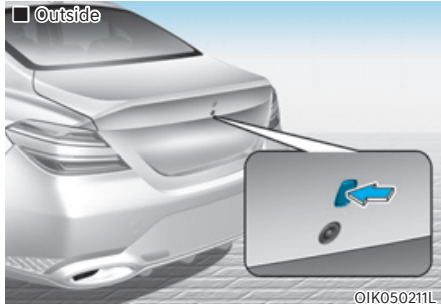

2. Then do one of the following :
  - Press the Smart Key Trunk Open button for more than one second.
  - Press the button on the trunk itself with the Smart Key in your possession.



- Use the trunk release button.
3. Lift the trunk lid up.

### Closing the trunk

Lower the trunk lid and press down until it locks. To be sure the trunk lid is securely fastened, always check by trying to pull it up again.

#### **WARNING**

Always keep the trunk lid completely closed while the vehicle is in motion. If it is left open or ajar, poisonous exhaust gases containing carbon monoxide (CO) may enter the vehicle and serious illness or death may result.

#### **Information**

To prevent damage to the trunk lift cylinders and the attached hardware, always close the trunk before driving.

#### **NOTICE**

In cold and wet climates, trunk lock and trunk mechanisms may not work properly due to freezing conditions.

#### **WARNING**

Your vehicle should be kept locked and keys should be kept out of the reach of children. Parents should teach their children about the dangers of playing in the trunk.

### Emergency trunk safety release

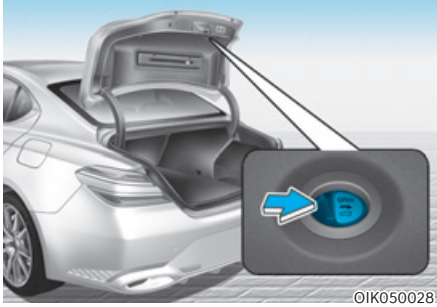

Your vehicle is equipped with an Emergency Trunk Safety Release lever located inside the trunk. When someone is inadvertently locked in the trunk, the trunk can be opened by moving the lever in the direction of the arrow and pushing the trunk open.

### WARNING

- You and your passengers must be aware of the location of the Emergency Trunk Safety Release lever in this vehicle and how to open the trunk in case you are accidentally locked in the trunk.
- **NEVER** allow anyone to occupy the trunk of the vehicle at any time. If the trunk is partially or totally latched and the person is unable to get out, serious injury or death could occur due to lack of ventilation, exhaust fumes and rapid heat build-up, or because of exposure to cold weather conditions. The trunk is also a highly dangerous location in the event of a crash because it is not a protected occupant space but is a part of the vehicle's crush zone.
- Your vehicle should be kept locked and the Smart Key should be kept out of the reach of children. Parents should teach their children about the dangers of playing in trunks.
- Use the release lever for emergencies only.

### When the vehicle battery is discharged or the trunk needs to be opened manually

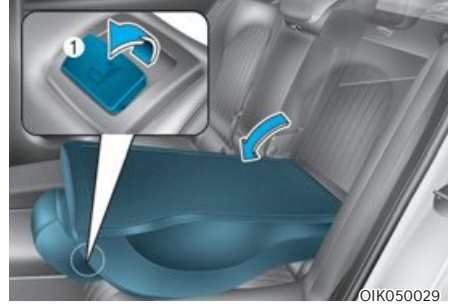

1. Fold the rear seats using the seatback folding lever (1).
2. Open the trunk using the Emergency Trunk Safety Release lever.

## Smart Trunk (if equipped)

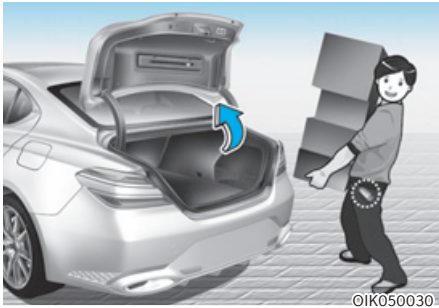

On a vehicle equipped with a smart key, the trunk can be opened with hands-free activation using the smart trunk system.

### **How to use the smart trunk**

The hands-free smart trunk system can be opened automatically when the following conditions are met:

- The smart trunk option is enabled the Settings menu in the infotainment system screen.
- The smart trunk is activated and ready 15 seconds after all the doors are closed and locked
- The smart trunk will open when the smart key is detected in the area behind the vehicle for 3 seconds

### **i Information**

The smart trunk will NOT operate when:

- Any door is open, or all doors are closed but not locked
- The smart key is detected within 15 seconds from when the doors were closed and locked
- For vehicles equipped with illuminated exterior front door handles, if the smart key is detected within 15 seconds from when the doors were closed and locked or if the smart key is within 60 in. (1.5 m) from the front door handles
- The smart key is in the vehicle.

#### 1. Settings

To use smart trunk, it must be enabled from the Settings menu in the infotainment system screen. Select:

- Setup → Vehicle Settings → Door → Smart Trunk

**See additional information in supplied Infotainment Manual.**

#### 2. Detect and Alert

The smart trunk detecting area extends approximately 20-40 in. (50-100 cm) behind the vehicle. If you are positioned in the detecting area and are carrying the smart key, the hazard warning lights will blink and the chime will sound to alert you that the smart trunk will open.

### **i Information**

**Do not approach the detecting area if you do not want the trunk to open. If you have unintentionally entered the detecting area and the hazard warning lights and chime starts to operate, move away from the area behind the vehicle with the smart key. The trunk will remain closed.**

#### 3. Automatic opening

After the hazard warning lights blink and the chime sounds 6 times, the smart trunk will open.

## Deactivating smart trunk



OIK050235N

1. Door lock
2. Door unlock
3. Trunk open
4. Panic button

If you press any button on the smart key during the Detect and Alert stage, the smart trunk function will be deactivated.

Make sure to be aware of how to deactivate the smart trunk function for emergency situations.

## **i** Information

- If you press the door unlock button (2), the smart trunk function will be deactivated temporarily. But, if you do not open any door for 30 seconds, the smart trunk function will be activated again.
- If you press the trunk open button (3) for more than 1 second, the trunk opens.
- The smart trunk function will still be activated if you press the door lock button (1) or trunk open button (3) on the smart key as long as the smart trunk is not already in the Detect and Alert stage.
- In case you have deactivated the smart trunk function by pressing the smart key button and opened a door, the smart trunk function can be activated again by closing and locking all doors.

### Detecting area



- The smart trunk detecting area extends approximately 20-40 in. (50-100 cm) behind the vehicle. If you are positioned in the detecting area and are carrying the smart key, the hazard warning lights will blink and the chime will sound for about 3 seconds to alert you that the smart trunk will open.
- The alert stops once the smart key is moved outside of the detecting area within the 3 second period.

### **i** Information

- The smart trunk function may not operate properly if any of the following instances occur:
  - The smart key is close to a radio transmitter such as a radio station or an airport which can interfere with normal operation of the transmitter.
  - The smart key is near a mobile two way radio system or a cellular phone.
  - Another vehicle's smart key is being operated close to your vehicle.
- The smart trunk detecting area may change when:
  - The vehicle is parked on an incline or slope.
  - One side of the vehicle is raised or lowered relative to the opposite side.

### Fuel Filler Door

#### Opening the fuel filler door



1. Turn the engine off.
2. Push the fuel filler door opener button.

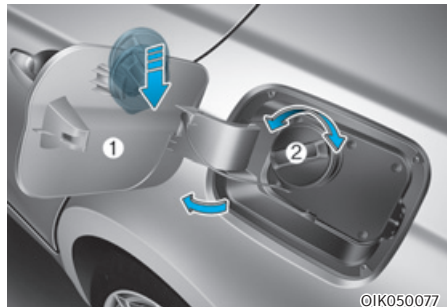

3. Pull the fuel filler door (1) outward to access the fuel tank cap.
4. To remove the fuel tank cap (2), turn it counterclockwise. You may hear a hissing noise as the pressure inside the tank equalizes.
5. Place the cap on the fuel filler door.

### **i** Information

If the fuel filler door does not open because ice has formed around it, tap lightly or push on the door to break the ice and release the door. Do not pry on the door. If necessary, spray around the door with an approved deicer fluid (do not use radiator antifreeze) or move the vehicle to a warm place and allow the ice to melt.

### ***Closing the fuel filler door***

1. To install the fuel tank cap, turn it clockwise until it “clicks” one time.
2. Close the fuel filler door until it is latched securely.

### ***i* Information**

The fuel filler door will not close if the driver’s door is locked. If you lock the driver’s door while fueling, unlock it before closing the fuel filler door.

### ***⚠* WARNING**

Gasoline is highly flammable and explosive. Failure to follow these guidelines may result in **SERIOUS INJURY or DEATH**:

- Read and follow all warnings posted at the gas station.
- Before refueling, note the location of the Emergency Gasoline Shut-Off, if available, at the gas station.
- Before touching the fuel nozzle, you should eliminate the potential build-up of static electricity by touching a metal part of the vehicle, a safe distance away from the fuel filler neck, nozzle, or other gas source, with your bare hand.
- Do not use mobile phones while refueling. Electric current and/or electronic interference from cellular phones can potentially ignite fuel vapors and cause a fire.
- Do not go back into the vehicle once you have begun refueling. You can generate a buildup of static electricity by touching, rubbing or sliding against any item or fabric capable of producing static electricity. Static electricity discharge can ignite fuel vapors causing a fire. If you must re-enter the vehicle, you should once again eliminate potentially dangerous static electricity discharge by touching a metal part of the vehicle, away from the fuel filler neck, nozzle or other Gasoline source, with your bare hand.
- When using an approved portable fuel container, be sure to place the container on the ground prior to refueling. Static electricity discharge from the container can ignite fuel vapors causing a fire. Once refueling has begun, contact between your bare hand and the vehicle should be maintained until the filling is complete.
- Use only approved portable plastic fuel containers designed to carry and store Gasoline.
- When refueling, always shift the vehicle to P(Park), apply the parking brake, and press the Engine Start/ Stop button to the OFF position. Sparks produced by electrical components related to the engine can ignite fuel vapors causing a fire.
- Do not use matches or a lighter and do not smoke or leave a lit cigarette in your vehicle while at a gas station, especially during refueling.
- Do not over-fill or top-off your vehicle tank, which can cause Gasoline spillage.

- If a fire breaks out during refueling, leave the vicinity of the vehicle, and immediately contact the manager of the gas station and then contact the local fire department. Follow any safety instructions they provide.
- If pressurized fuel sprays out, it can cover your clothes or skin and thus subject you to the risk of fire and burns. Always remove the fuel cap carefully and slowly. If the cap is venting fuel or if you hear a hissing sound, wait until the condition stops before completely removing the cap.
- Always check that the fuel cap is installed securely to prevent fuel spillage in the event of an accident.

### **i** Information

Make sure to refuel your vehicle according to the “Fuel Requirements” section in suggested in chapter 1.

### **NOTICE**

- Do not spill fuel on the exterior surfaces of the vehicle. Any type of fuel spilled on painted surfaces may damage the paint.
- If the fuel filler cap requires replacement, use only a genuine Genesis cap or the equivalent specified for your vehicle. An incorrect fuel filler cap can result in a serious malfunction of the fuel system or emission control system.

### **Emergency fuel filler door release**

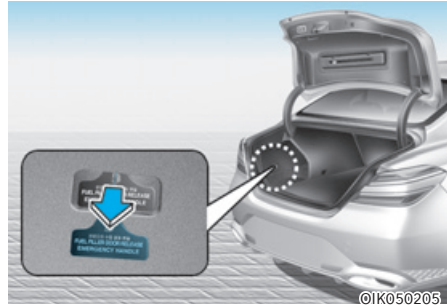

If the fuel filler door does not open using the remote fuel filler door release button, you can open it manually. Pull the handle of the release located on the left side of the luggage compartment outward slightly.

## HEAD-UP DISPLAY (HUD) (IF EQUIPPED)

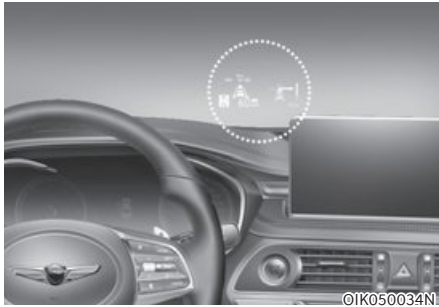

The Head-Up Display is a feature that allows the driver to view information projected onto a transparent screen while still keeping their eyes on the road ahead while driving.

### Head-Up Display Settings

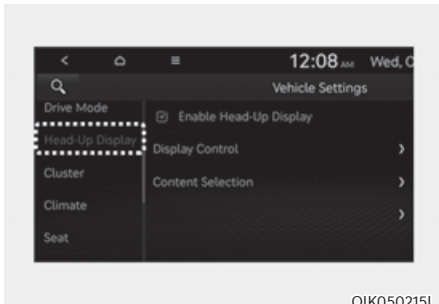

- Head-up display can be enabled from the Settings menu in the infotainment system screen. Select:
  - Setup → Vehicle Settings → Head-Up Display → Enable Head-Up Display
- After turning on the head-up display, you can change the settings of 'Display Control' and 'Content Selection' of the head-up display.

**See additional information in supplied Infotainment Manual.**

### Head-Up Display Information

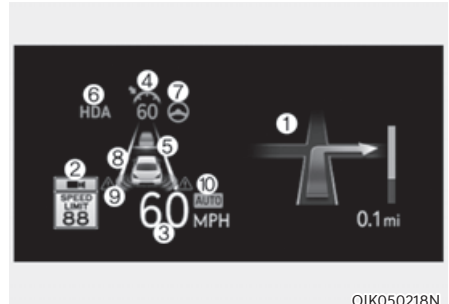

1. Turn by Turn (TBT) navigation information
2. Traffic information
3. Speedometer
4. SCC set speed information
5. SCC vehicle distance information
6. Highway Driving Assist
7. Lane Following Assist
8. Lane safety
9. Blind-Spot Safety
10. Highway Auto Speed Change



### Precautions While Using the Head-Up Display

- It may sometimes be difficult to read information on the head-up display in the following situations.
  - The driver is improperly positioned in the driver's seat.
  - The driver wears polarizing-filter sunglasses.
  - An object is located above the head-up display cover
  - The vehicle is driven on a wet road.
  - Any improper lighting accessory is installed inside the vehicle, or there is incoming light from outside of the vehicle.
  - The driver wears glasses.
  - The driver wears contact lenses.

When it is difficult to read the head up display information, adjust the image height or brightness level from the Settings menu in the infotainment system screen.

**See additional information in supplied Infotainment Manual.**

- For your safety, make sure to stop the vehicle before adjusting the settings.
- Do not tint the front windshield glass or add other types of metallic coating. Otherwise, the head-up display image may be invisible.
- Do not place any accessories on the crash pad or attach any objects on the windshield glass.
- When replacing the front windshield glass, replace it with a windshield glass designed for head-up display operation. Otherwise, duplicated images may be displayed on the windshield glass.



#### **WARNING**

**The warning information of Blind-Spot Collision Warning on the head-up display are supplemental. Do not solely depend on them to change lanes. Always take a look around before changing lanes.**



#### **Information**

**Head-up Display includes GPL, LGPL, MPL and other open source license software. All license notices including related source code are provided at <http://www.mobis.co.kr/opensource/list.do>.**

**If the driver requests on-board software open source code via [MOBIS\\_OSSrequest@mobis.co.kr](mailto:MOBIS_OSSrequest@mobis.co.kr) within 3 years after buying this product, a CD-ROM or other storage device will be sent with the minimum cost covering storage device cost and delivery cost.**

## LIGHTING

### Exterior Lights

#### Lighting control

To operate the lights, turn the knob at the end of the control lever to one of the following positions:

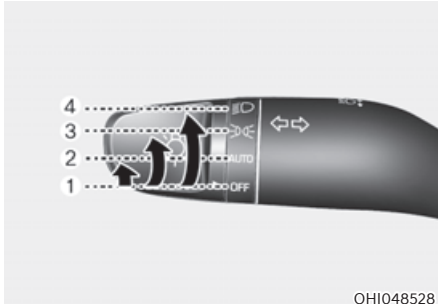

OHI048528

1. OFF position
2. AUTO headlamp position
3. Parking lamp position
4. Headlamp position

#### Daytime Running Light (DRL)

The Daytime Running Lights (DRL) can make it easier for others to see the front of your vehicle during the day, especially after dawn and before sunset.

The DRL system will turn the dedicated lamp OFF when :

- The headlamps are ON.
- The parking brake is applied.
- The vehicle is turned off.

#### Auto headlamp (OFF position)

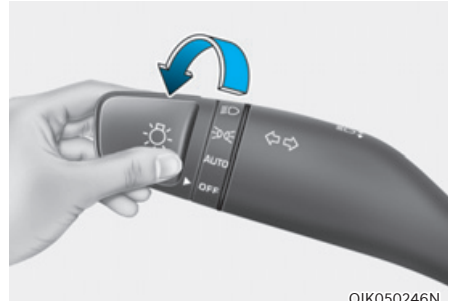

OIK050246N

The lights turn on or off depending on the amount of daylight detected by the sensor when the parking brake is not activated or vehicle speed is above 3 mph (5 km/h).

Activating the parking brake when the vehicle speed less than 3 mph (5 km/h) can turn off automatically lit headlamp by the amount of daylight.

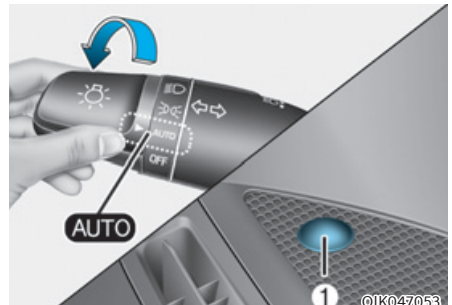

©IK047053

#### AUTO headlamp position

The parking lamp and headlamp will be turned ON or OFF automatically depending on the amount of daylight as measured by the ambient light sensor (1) at the upper end of the windshield glass.

**NOTICE**

- Even with the AUTO headlamp feature in operation, it is recommended to manually turn ON the headlamps when driving at night or in a fog, driving in the rain, or when you enter dark areas, such as tunnels and parking facilities.
- Do not cover or spill anything on the sensor (1) located at the upper end of the windshield glass.
- Do not clean the sensor using a window cleaner, the cleanser may leave a light film which could interfere with sensor operation.
- If your vehicle has window tint or other types of metallic coating on the front windshield, the AUTO headlamp system may not work properly.



OHI048530

**Parking lamp position (P)**

The parking lamp, license plate lamp and instrument panel lamp are turned ON.



OHI048529

**Headlamp position (D)**

The headlamp, parking lamp, license plate lamp and instrument panel lamp are turned ON.

**i Information**

The Engine Start/Stop button must be in the ON position to turn on the headlamp.

### High beam operation

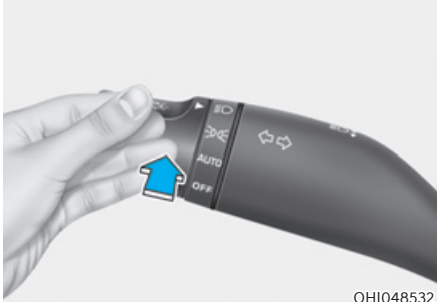

OHI048532

To turn on the high beam headlamp, push the lever away from you. The lever will return to its original position.

The high beam indicator will light when the headlamp high beams are switched on.

To turn off the high beam headlamp, pull the lever towards you. The low beams will turn on.

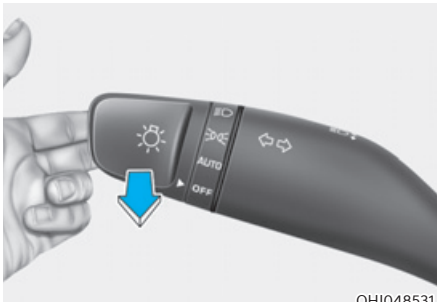

OHI048531

To flash the high beam headlamp, pull the lever towards you, then release the lever. The high beams will remain ON as long as you hold the lever towards you.

### Turn signals and lane change signals

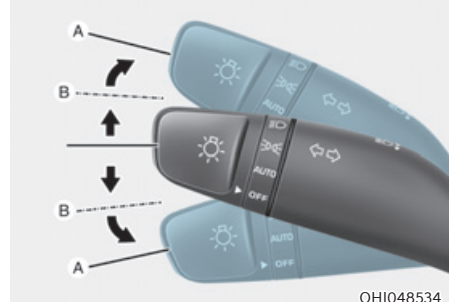

OHI048534

To signal a turn, push down on the lever for a left turn or up for a right turn in position (A).

If an indicator stays on and does not flash or if it flashes abnormally, one of the turn signal bulbs may be burned out and will require replacement.

#### One touch turn signal

To use One Touch Turn Signal push the turn signal lever up or down to position (B) and then release it.

The lane change signals will blink 3, 5 or 7 times.

You can enable the One Touch Turn Signal function or choose the number of blinking by selecting 'Setup → Vehicle Settings → Lights → One Touch Turn Signal (or One-touch indicator) → 3 flashes/5 flashes /7 flashes/Off' in the infotainment system screen.

**See additional information in supplied Infotainment Manual.**

### ***Battery saver function***

The purpose of this feature is to help prevent the battery from being discharged. The system automatically turns off the parking lamp when the driver turns the vehicle off and opens the driver-side door.

With this feature, the parking lamps will turn off automatically if the driver parks on the side of road at night.

If necessary, to keep the lamps on when the vehicle is turned off, perform the following:

- (1) Open the driver-side door.
- (2) Turn the parking lamps OFF and ON again using the headlamp switch on the steering column.

### ***Headlamp delay function***

If the Engine Start/Stop button is in the ACC parking or the OFF position with the headlamps ON, the headlamps (and/or parking lamps) remain on for about 5 minutes. However, if the driver's door is opened and closed, the headlamps are turned off after 15 seconds. Also, with the vehicle off if the driver's door is opened and closed, the headlamps (and/or parking lamps) are turned off after 15 seconds.

The headlamps (and/or parking lamps) can be turned off by pressing the lock button on the smart key twice or turning the headlamp switch to the OFF or AUTO position.

You can enable the headlamp delay function by selecting 'Setup → Vehicle Settings → Lights → Headlight Delay' in the infotainment system screen.

**See additional information in supplied Infotainment Manual.**

### **NOTICE**

**If the driver exits the vehicle through another door besides the driver door, the battery saver function does not operate and the headlamp delay function does not turn OFF automatically.**

**This may cause the battery to discharge. To avoid battery discharge, turn OFF the headlamps manually from the headlamp switch before exiting the vehicle.**

### ***Headlamp moisture removal function***

When moisture fogs up inside of the headlamp with the headlamp on for a certain period of time, the fan circulates air inside the headlamp to remove moisture. If moisture is not removed, have the vehicle inspected by an authorized retailer of Genesis Branded products.

### **Puddle Lamp (if equipped)**



#### ***Welcome light***

When all doors (and trunk) are closed and locked, the puddle lamp will turn on for 15 seconds if the door is unlocked by the smart key or when you put your hand in the outside door handle with the smart key in possession.

**For more details, refer to “Welcome System” in this chapter.**

#### ***Escort light***

When the Engine Start/Stop button is in the OFF position and the driver’s door is opened, the puddle lamp will turn on for 30 seconds. If the driver’s door is closed within the 30 second period, the puddle lamp will turn off after 15 seconds. If the driver’s door is closed and locked, the puddle lamp will turn off immediately.

The Puddle Lamp Escort Light will turn on only the first time the driver’s door is opened after the engine is turned off.

### Welcome System



Welcome system helps keep the driver visible by turning on vehicle lights when the driver approaches the vehicle.

### Puddle lamp and door handle lamp

When all the doors (and trunk) are closed and locked, the puddle lamp and door handle lamp will turn on for approximately 15 seconds if any of the below is performed.

- When the door unlock button is pressed on the smart key.
- When you put your hand in the outside door handle with the smart key in possession.
- If 'Setup → Vehicle Settings → Convenience → Welcome Mirror/Light → Enable on Driver Approach' is selected from the Settings menu in the infotainment system screen, the lamps will turn on when the vehicle is approached with the smart key in possession.

**See additional information in supplied Infotainment Manual.**

### Headlamp and parking lamp

When the light switch is ON, and all the doors (and trunk) are closed and locked, the headlamp and parking lamp will turn on for approximately 15 seconds if the door unlock button is pressed on the smart key. Note that if the light switch is in the AUTO position, the headlamp and position light will turn on only when it is dark outside.

Select 'Setup → Lights → Headlight Delay' from the Settings menu to turn on this function.

### Interior lamp

When the interior lamp switch is in the  position and all doors (and trunk) are closed and locked, the room lamp will come on for 30 seconds if any of the below is performed.

- When the door unlock button is pressed on the smart key.
- When you put your hand in the outside door handle while carrying the smart key.

At this time, if you press the door lock or unlock button on the smart key the lamps will turn off immediately.

## HIGH BEAM ASSIST (HBA)



OIK047090

High Beam Assist will automatically adjust the headlamp range (switches between high beam and low beam) depending on the brightness of detected vehicles and certain road conditions.

### Detecting sensor (Front view camera)

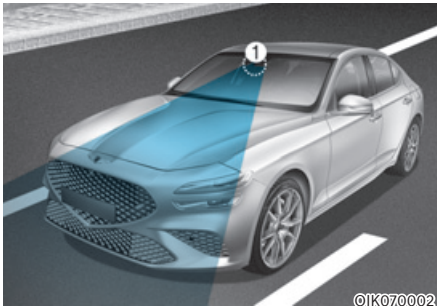

OIK070002

[1] : Front view camera

The front view camera is used as a detecting sensor to detect ambient light and brightness while driving.

Refer to the picture above for the detailed location of the detecting sensor.

### NOTICE

Always keep the front view camera in good condition to maintain optimal performance of High Beam Assist.

For more details on the precautions of the front view camera, refer to “Forward Collision-Avoidance Assist (FCA)” section in chapter 7.

### High Beam Assist Settings

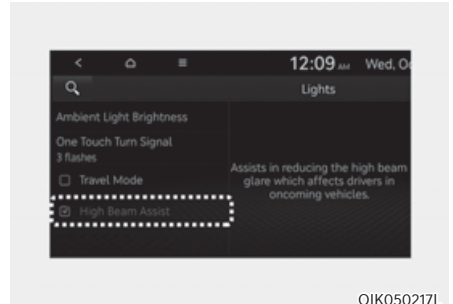

OIK050217L

With the Engine Start/Stop button in the ON position, select ‘Lights → High Beam Assist’ from the Settings menu to turn on High Beam Assist and deselect to turn off the system.



### WARNING

For your safety, change the Settings after parking the vehicle at a safe location.



## High Beam Assist Operation

### Display and control

- After selecting 'High Beam Assist' in the Settings menu, High Beam Assist will operate by following the procedure below.
  - Place the headlamp switch in the AUTO position and push the headlamp switch towards the instrument cluster. The High Beam Assist (AUTO) indicator light will illuminate on the cluster and HBA will be enabled.
  - When High Beam Assist is enabled, high beam will turn on when vehicle speed is above 25 mph (40 km/h). When vehicle speed is below 20 mph (30 km/h), high beam will not turn on.
  - The High Beam (HBM) indicator light will illuminate on the cluster when high beam is on.
- When High Beam Assist is operating, if the headlamp switch or switch is HBA operates as follow:
  - If the headlamp switch is pulled towards you when the high beam is off, the high beam will turn on without High Beam Assist canceled. When you let go of the headlamp switch, the switch will move to the middle and the high beam will turn off.
  - If the headlamp switch is pulled towards you when the high beam is on by High Beam Assist, low beam will be on and the system will turn off.
  - If the headlamp switch is placed from AUTO to another position (headlamp/position/off), High Beam Assist will turn off and the corresponding lamp will turn on.

- When High Beam Assist is operating, high beam switches to low beam if any of the following conditions occur:
  - When the headlamp of an oncoming vehicle is detected.
  - When the tail lamp of a vehicle in front is detected.
  - When the headlamp or tail lamp of a motorcycle or a bicycle is detected.
  - When the surrounding ambient light is bright enough that high beams are not required.
  - When streetlights or other lights are detected.

## High Beam Assist Malfunction and Limitations

### High Beam Assist malfunction

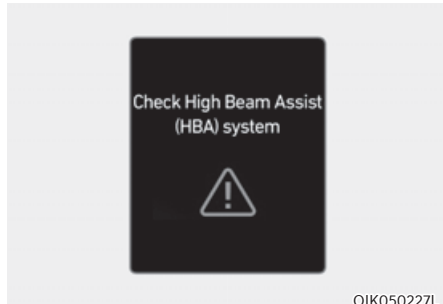

When High Beam Assist is not working properly, the 'Check High Beam Assist (HBA) system' warning message will appear and  light will illuminate on the cluster. Have the vehicle inspected by an authorized retailer of Genesis Branded products.

### **Limitations of High Beam Assist**

High Beam Assist may not work properly in the following situations:

- Light from a vehicle is not detected because of lamp damage, or because it is hidden from sight, etc.
- Headlamp of a vehicle is covered with dust, snow or water.
- A vehicle's headlamps are off but the fog lamps are on and etc.
- There is a lamp that has a similar shape as a vehicle's lamp.
- Headlamps have been damaged or not repaired properly.
- Headlamps are not aimed properly.
- Driving on a narrow curved road, rough road, uphill or downhill.
- Vehicle in front is partially visible on a crossroad or curved road.
- There is a traffic light, reflecting sign, flashing sign or mirror ahead.
- There is a temporary reflector or flash ahead (construction area).
- The road conditions are bad such as being wet, iced or covered with snow.
- A vehicle suddenly appears from a curve.
- The vehicle is tilted from a flat tire or is being towed.
- Light from a vehicle is not detected because of exhaust fume, smoke, fog, snow, etc.

### **NOTICE**

**For more details on the limitations of the front view camera, refer to "Forward Collision-Avoidance Assist (FCA)" section in chapter 7.**



### **WARNING**

- **At times, High Beam Assist may not work properly. The system is for your convenience only. It is the responsibility of the driver for safe driving practices and always check the road conditions for your safety.**
- **When High Beam Assist does not operate normally, change the headlamp position manually between high beam and low beam.**

## INTERIOR LIGHTS

### WARNING

Do not use the interior lights when driving in the dark. The interior lights may obscure your view and cause an accident.

### NOTICE

Do not use the interior lights for extended periods when the vehicle is turned off or the battery will discharge.

### Interior Lamp AUTO cut

The interior lamps will automatically go off approximately 20 minutes after the vehicle is turned off and the doors are closed. If a door is opened, the lamp will go off 40 minutes after the vehicle is turned off. If the doors are locked by the smart key and the vehicle enters the armed stage of the theft alarm system, the lamps will go off five seconds later.

## Front Lamps

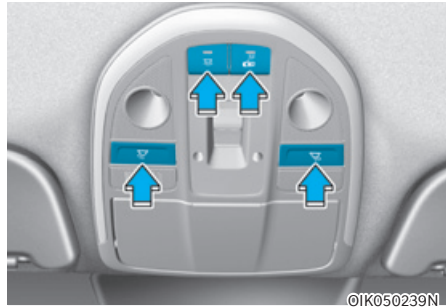

### Front map lamp ( ):

Touch either icons to turn the map lamp on or off. This light produces a spot beam for convenient use as a map lamp at night or as a personal lamp for the driver and the front passenger.

### Door lamp ()

The front or rear room lamps come on when the front or rear doors are opened. When doors are unlocked by the smart key, the front and rear lamps come on for approximately 30 seconds as long as any door is not opened. The front and rear room lamps go out gradually after approximately 30 seconds when the door is closed. However, if the Engine Start/Stop button is in the ON position or all doors are locked, the front and rear lamps will turn off. If a door is opened with the Engine Start/Stop button in the ACC position or the OFF position, the front and rear lamps will stay on for about 20 minutes.

### Room lamp ()

Press the button to turn ON the room lamp for the front/rear seats.

## Rear Lamps

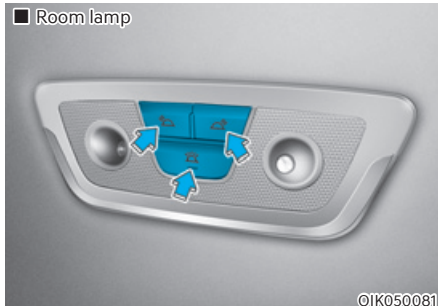

### **Rear room lamp** ( )

Press this button to turn the room lamp on or off.

### **Rear map lamp** ( )

Press either of these buttons to turn either side of the rear lamp on or off.

### **NOTICE**

**Do not leave the lamp switches on for an extended period of time when the engine is turned off.**

## Vanity Mirror Lamp

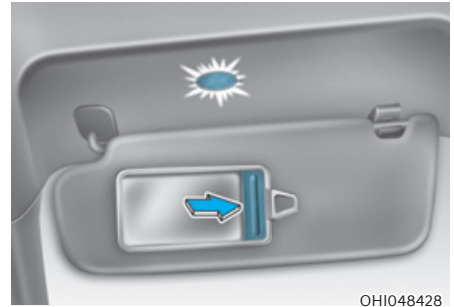

Opening the lid of the vanity mirror will automatically turn on the mirror lamp.

### Glove Box Lamp

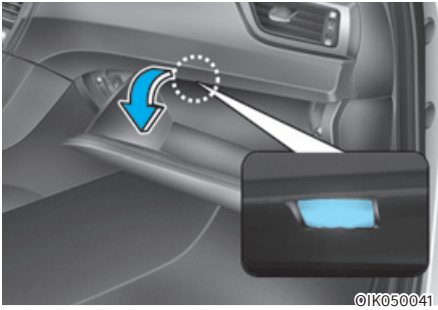

The glove box lamp turns on when the glove box is opened.

### Trunk Lamp

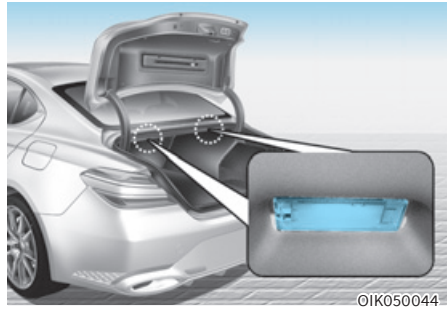

The trunk lamp comes on when the trunk is opened.

### Foot Lamp

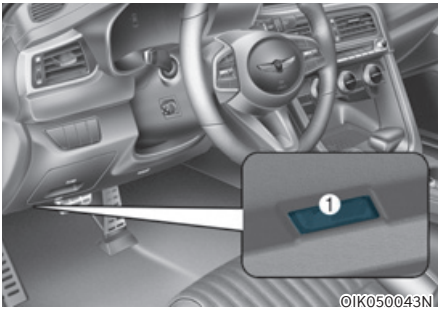

The foot lamp (1) turns on when a door is open and turns off when the door is closed.

## WIPERS AND WASHERS

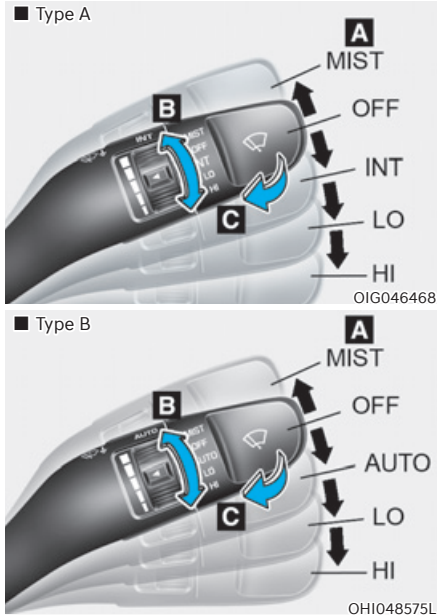

### A : Wiper speed control

- MIST – Single wipe
- OFF – Off
- INT – Intermittent wipe
- AUTO – Automatic control wipe
- LO – Low wiper speed
- HI – High wiper speed

### B : Auto control wipe time adjustment

### C : Wash with brief wipes

## Front Windshield Wipers

Operates as follows when the Engine Start/Stop button is in the ON position.

**MIST :** For a single wiping cycle, push the lever upward and release. The wipers will operate continuously if the lever is held in this position.

**OFF :** Wiper is not in operation.

**INT :** Wiper operates intermittently at the same wiping intervals. To vary the speed setting, move the speed control lever. The top most setting will run the wipers most frequently (for more rain). The bottom setting will run the wipers the least frequently (for less rain).

**AUTO :** The rain sensor located on the upper end of the windshield glass senses the amount of rainfall and controls the wiping cycle for the proper interval. The more it rains, the faster the wiper operates. When the rain stops, the wiper stops. To vary the speed setting, turn the speed control knob.

**LO :** The wiper runs at a lower speed.

**HI :** The wiper runs at a higher speed.

## **i** Information

**If there is heavy accumulation of snow or ice on the windshield, defrost the windshield for about 10 minutes, or until the snow and/or ice is removed before using the windshield wipers to ensure proper operation.**

**If you do not remove the snow and/or ice before using the wiper and washer, it may damage the wiper and washer system.**

### **AUTO (Automatic) control**



The rain sensor located on the upper end of the windshield glass senses the amount of rainfall and controls the wiping cycle for the proper interval.

The wiper operation time will be automatically controlled, depends on rainfall.

When the rain stops, the wiper stops.

To vary the sensitivity setting, turn the sensitivity control knob.

If the wiper switch is set in AUTO mode when the Engine Start/Stop button is in the ON position, the wiper will operate once to perform a self-check of the system. Set the wiper to the OFF position when the wiper is not in use.

### **WARNING**

To avoid personal injury from the windshield wipers, when the engine is running and the windshield wiper switch is placed in the AUTO mode:

- Do not touch the upper end of the windshield glass facing the rain sensor.
- Do not wipe the upper end of the windshield glass with a damp or wet cloth.
- Do not put pressure on the windshield glass.

### **NOTICE**

- When washing the vehicle, set the wiper switch in the OFF position to stop the auto wiper operation. The wiper may operate and be damaged if the switch is set in the AUTO mode while washing the vehicle.
- Do not remove the sensor cover located on the upper end of the passenger side windshield glass. Damage to system components could occur and may not be covered by your vehicle warranty.
- Because of using a photo sensor, temporary malfunction could occur according to sudden ambient light change made by stone and dust while driving.

## Windshield Washers

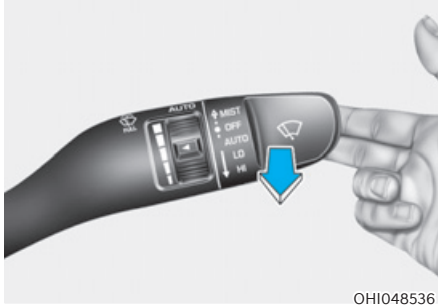

In the OFF position, pull the lever gently toward you to spray washer fluid on the windshield and to run the wipers 1-3 cycles. The spray and wiper operation will continue until you release the lever. If the washer does not work, you may need to add washer fluid to the washer fluid reservoir.

### ***Recirculating air when washer fluid is used***

When washer fluid is used, in order to help prevent the scent from entering the cabin, recirculation mode and air conditioning are automatically activated depending on the outside temperature. If you select fresh mode while the function is operating, the function will resume after a certain amount of time. It may not work in some conditions such as cold weather or engine OFF.

**For more details, refer to “Climate Control Additional Features” section in this chapter.**

### **WARNING**

When the outside temperature is below freezing, **ALWAYS** warm the windshield using the defroster to help prevent the washer fluid from freezing on the windshield and obscuring your vision which could result in an accident and serious injury or death.

### **NOTICE**

- To prevent possible damage to the washer pump, do not operate the washer when the fluid reservoir is empty.
- To prevent possible damage to the wipers or windshield, do not operate the wipers when the windshield is dry.
- To prevent damage to the wiper arms and other components, do not attempt to move the wipers manually.
- To prevent possible damage to the wipers and washer system, use anti-freezing washer fluids in the winter season or cold weather.



## AUTOMATIC CLIMATE CONTROL SYSTEM

- Type A



- Type B



The switch arrangements may vary depending on which functions are applicable to your vehicle.

OIK047300/OIK047301

1. Driver's temperature control knob
2. Passenger's temperature control knob
3. AUTO (automatic control) button
4. OFF button
5. Front windshield defroster button
6. Fan speed control knob
7. Air intake control button
8. Mode selection button
9. SYNC button
10. Climate control information screen selection button
11. Rear window defroster button
12. Air conditioning button

- Type C



- Type D



The switch arrangements may vary depending on which functions are applicable to your vehicle.

OIK050220L/OIK050223L

- |   |   |
|---|---|
| 1. Driver's temperature control knob    | 8. Mode selection button                                |
| 2. Passenger's temperature control knob | 9. SYNC button  |
| 3. AUTO (automatic control) button      | 10. Climate control information screen selection button |
| 4. OFF button                           | 11. Rear window defroster button                        |
| 5. Front windshield defroster button    | 12. Air conditioning button                             |
| 6. Fan speed control knob               |   |
| 7. Air intake control button            |   |

## Automatic Heating and Air Conditioning

The Automatic Climate Control System is controlled by setting the desired temperature.



1. Press the AUTO button.

The modes, fan speeds, air intake and air-conditioning will be controlled automatically by the temperature setting you select.

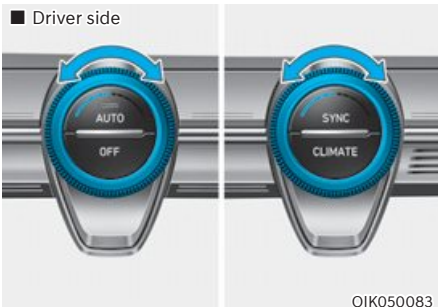

2. Turn the temperature control knob to the desired temperature. If the temperature is set to the lowest setting (Lo), the air conditioning system will operate continuously.

To turn the automatic operation off, select any button of the following:

- Mode selection button
- Air conditioning button
- Front windshield defroster button (Press the button one more time to deselect the front windshield defroster function. The 'AUTO' sign will illuminate on the information display once again.)
- Air intake control button
- Fan speed control button

The selected function will be controlled manually while other functions operate automatically.

For your convenience and to improve the effectiveness of the climate control, use the AUTO button and set the temperature to 72°F (22°C).

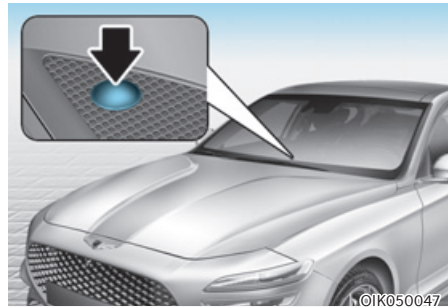



### Information

**Never place anything near the sensor to ensure better control of the heating and cooling system.**

## Manual Heating and Air Conditioning

The heating and cooling system can be controlled manually by pushing buttons other than the AUTO button. In this case, the system works sequentially according to the order of buttons selected. When pressing any button except the AUTO button while using automatic operation, the functions not selected will be controlled automatically.

1. Start the engine.
2. Set the mode to the desired position.  
For improving the effectiveness of heating and cooling, select:
  - Heating: 
  - Cooling: 
3. Set the temperature control to the desired position.
4. Set the air intake control to the outside (fresh) air position.
5. Set the fan speed control to the desired speed.
6. If air conditioning is desired, turn the air conditioning system on.
7. Press the AUTO button to convert to full automatic control of the system.

### Mode selection

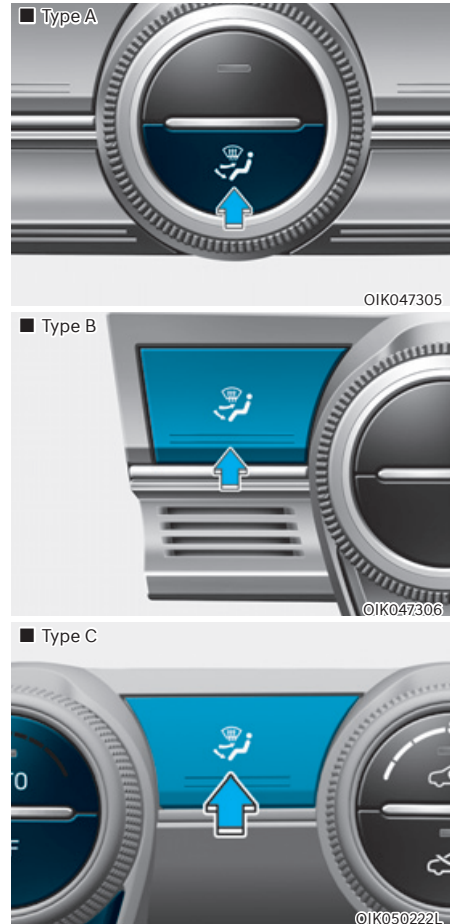

The mode selection button controls the direction of the air flow through the ventilation system.

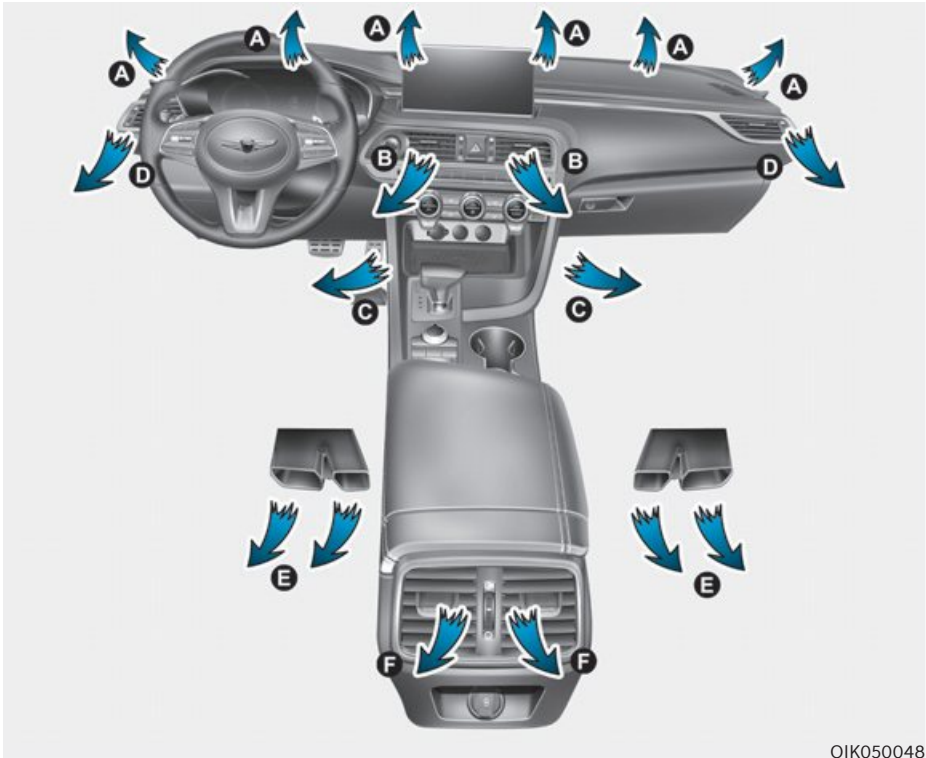

OIK050048

**Air flow direction**

The air flow outlet port is converted as follows:





### Face-Level (B, D, F)

Air flow is directed toward the upper body and face. Additionally, each outlet can be controlled to direct the air discharged from the outlet.



### Bi-Level (B, D, C, E, F)

Air flow is directed towards the face and the floor.



### Floor-Level (A, C, D, E, F)

Most of the air flow is directed to the floor, with a small amount of the air being directed to the windshield and side window defrosters.



### Floor/Defrost-Level (A, C, D, E, F)

Most of the air flow is directed to the floor and the windshield with a small amount directed to the side window defrosters.

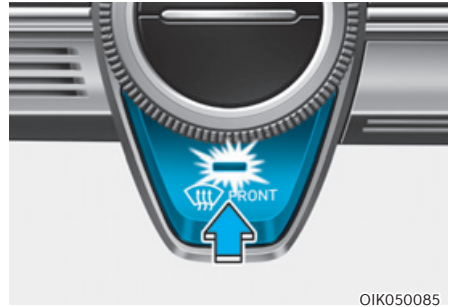

©IK050085

### Defrost-Level (A)

Most of the air flow is directed to the windshield with a small amount of air directed to the side window defrosters.

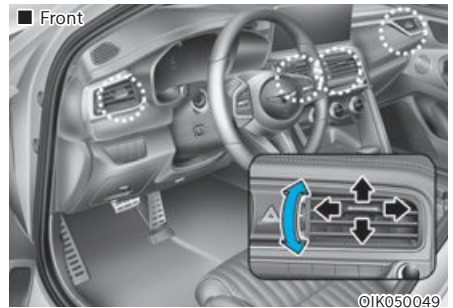

©IK050049

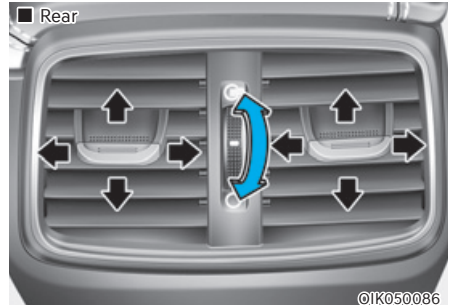

©IK050086

### Instrument panel vents

The outlet vents can be opened (☞) or closed (○) separately using the thumbwheel.

Also, you can adjust the direction of air delivery from these vents using the vent control lever as shown.

### Temperature control

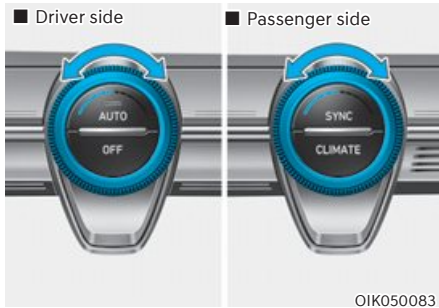

The temperature will increase by turning the knob to the right. The temperature will decrease by turning the knob to the left.



### Adjusting the driver and passenger side temperature equally

- Press the “SYNC” button to adjust the driver and passenger side temperature equally.

The passenger side temperature will be set to the same temperature as the driver side temperature.

- Turn the driver side temperature control knob. The driver and passenger side temperature will be adjusted equally.

### Adjusting the driver and passenger side temperature individually

Press the “SYNC” button again to adjust the driver and passenger side temperature individually. The button indicator will turn off.

### Temperature conversion

If the battery has been discharged or disconnected, the temperature mode display will reset to Fahrenheit.

To change the temperature unit from °C to °F or °F to °C :

- Automatic climate control system  
Press the AUTO button for 3 seconds while pressing the OFF button.
- You can change the temperature unit from the Settings menu in the infotainment system screen. Select:
  - Setup → General Settings → Unit → Temperature Unit → °C/°F

The temperature unit on both the infotainment system screen and the climate control screen will change.

## Air intake control

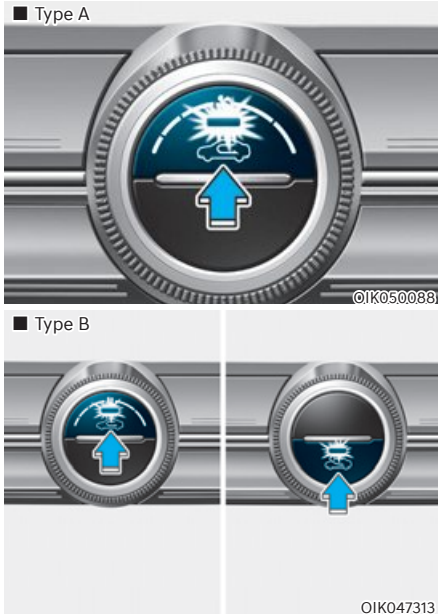

This is used to select the outside (fresh) air position or recirculated air position. To change the air intake control position, push the control button.

## Recirculated air position



With the recirculated air position selected, air from the passenger compartment will be drawn through the heating system and heated or cooled according to the function selected.

## Outside (fresh) air position

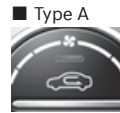

With the outside (fresh) air position selected, air enters the vehicle from outside and is heated or cooled according to the function selected.

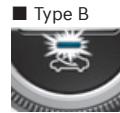

## Information

Using the system in the fresh air position is recommended.

**Prolonged operation of the heater in the recirculated air position (without air conditioning selected) may cause fogging of the windshield and side windows and the air within the passenger compartment may become stale.**

**In addition, prolonged use of the air conditioning with the recirculated air position selected will result in excessively dry air in the passenger compartment.**





## WARNING

- Continued climate control system operation in the recirculated air position may allow humidity to increase inside the vehicle which may fog the glass and obscure visibility.
- Do not sleep in a vehicle with the air conditioning or heating system on. It may cause serious harm or death due to a drop in the oxygen level and/or body temperature.
- Continued climate control system operation in the recirculated air position can cause drowsiness or sleepiness, and loss of vehicle control. Set the air intake control to the outside (fresh) air position as much as possible while driving.

## Fan speed control

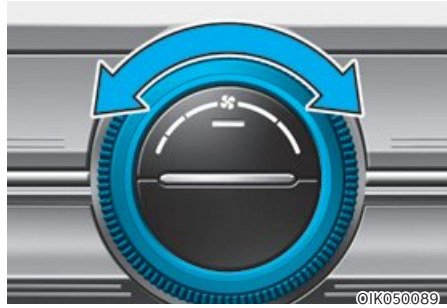

The fan speed can be set to the desired speed by turning the fan speed control knob. Turn the knob to the right for higher fan speed.

Pressing the OFF button turns off the fan.



## Information

For better sound quality, fan speed may automatically slow down for a couple of minutes when you activate voice recognition or hands free.

## NOTICE

Operating the fan speed when the Engine Start/Stop button is in the ON position could cause the battery to discharge. Operate the fan speed when the engine is running.

## Air conditioning

■ Type A or B

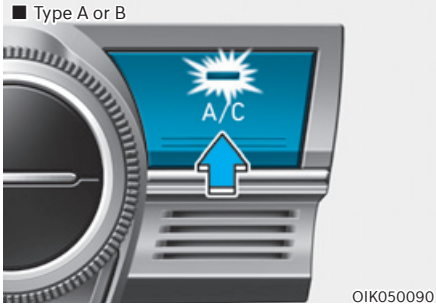

OIK050090

■ Type C or D



OIK050221L

Push the A/C button to turn the air conditioning system on (indicator light will illuminate).

Push the button again to turn the air conditioning system off.

## OFF mode



OIK050091

Push the OFF button to turn the climate control system off. However, you can still operate the mode and air intake buttons as long as the Engine Start/Stop button is in the ON position.

## Climate control information screen selection button



OIK050092

Press the climate control information screen selection button to display climate control information on the Infotainment system screen.

### System Operation

#### Cooling / Ventilation

1. Select the Face Level (👤) mode.
2. Set the air intake control to the outside (fresh) air position.
3. Set the temperature control to the desired position.
4. Set the fan speed control to the desired speed.

#### Heating

1. Select the Floor Level (👤) mode.
2. Set the air intake control to the outside (fresh) air position.
3. Set the temperature control to the desired position.
4. Set the fan speed control to the desired speed.
5. If desired, turn the air conditioning ON with the temperature control knob set to heat in order to dehumidify the air before it enters into the cabin.

If the windshield fogs up, select the Front Defrost (👤) mode.

#### Operation Tips

- To help keep dust or unpleasant fumes from entering the vehicle through the ventilation system, temporarily set the air intake control to the recirculation mode. Return the control to the to Fresh mode when the unpleasant air outside has diminished. This will help keep the driver alert and comfortable.
- To help prevent the inside of the windshield from fogging, set the air intake control to fresh mode and the fan speed to the desired position, turn on the air conditioning system, and adjust the temperature control to the desired temperature.

#### Air conditioning

Your Genesis Branded Vehicle air conditioning system is filled with R-134a or R-1234yf refrigerant.

1. Start the vehicle.
2. Press the air conditioning button.
3. Set the mode to the Face Level (👤) mode.
4. Set the air intake control to Recirculation mode temporarily to allow the cabin to cool quickly. When the desired temperature in the cabin is reached, change the air intake control back to Fresh mode.
5. Adjust the fan speed control and temperature control to maintain maximum comfort.

When maximum cooling is desired, set the temperature control to the lowest position, then set the fan speed control to the highest setting.

#### NOTICE

**When using the air conditioning system, monitor the engine temperature gauge closely while driving up hills or in heavy traffic when outside temperatures are high. Air conditioning system operation when climbing a steep grade or in high outside ambient temperatures can cause engine overheating. Continue to use the fan, but turn the air conditioning system off if the engine temperature gauge indicates engine overheating.**

### Air conditioning system operation tips

- If the vehicle has been parked in direct sunlight during hot weather, open the windows for a short time to let the hot air inside the vehicle escape.
- After sufficient cooling has been achieved, switch back from recirculation mode to fresh mode.
- To help reduce moisture inside of the windows on rainy or humid days, decrease the humidity inside the vehicle by operating the air conditioning system with the windows and sunroof closed.
- Use the air conditioning system every month only for a few minutes to ensure maximum system performance.
- If you operate air conditioner excessively, the difference between the temperature of the outside air and that of the windshield could cause the outer surface of the windshield to fog up, causing loss of visibility. In this case, set the mode selection to the (↔) position and fan speed control to the lowest speed.

## System Maintenance

### Cabin air filter

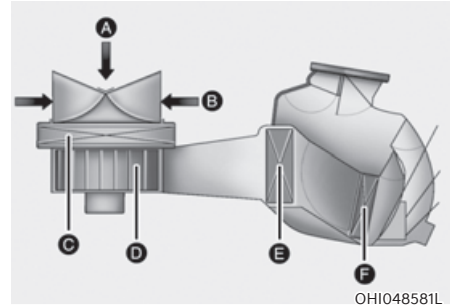

[A] : Outside air, [B] : Recirculated air

[C] : Climate control air filter, [D] : Blower

[E] : Evaporator core, [F] : Heater core

The cabin air filter is installed behind the glove box. It filters the dust or other pollutants that enter the vehicle through the heating and air conditioning system.

We recommend that the cabin air filter be replaced by an authorized retailer of Genesis Branded products according to the maintenance schedule. If the vehicle is being driven in severe conditions such as dusty or rough roads, more frequent cabin air filter inspections and changes are required.

If the air flow rate suddenly decreases, we recommend that the system be inspected at an authorized retailer of Genesis Branded products.

### Checking the amount of air conditioner refrigerant and compressor lubricant

When the amount of refrigerant is low, the performance of the air conditioning is reduced. Overfilling also reduces the performance of the air conditioning system.

Therefore, if abnormal operation is found, we recommend that the system be inspected by an authorized retailer of Genesis Branded products.

#### NOTICE

It is important that the correct type and amount of oil and refrigerant is used. Otherwise, damage to the compressor and abnormal system operation may occur. To prevent damage, the air conditioning system in your vehicle should only be serviced by trained and certified technicians.

#### WARNING

Vehicles equipped with R-1234yf



Since the refrigerant is mildly flammable and operated at high pressure, the air conditioning system should only be serviced by trained and certified technicians. It is important that the correct type and amount of oil and refrigerant are used.

All refrigerants should be reclaimed with proper equipment.

Venting refrigerants directly to the atmosphere is harmful to individuals and environment. Failure to heed these warnings can lead to serious injuries.

### Air Conditioning refrigerant label



You can find out which air conditioning refrigerant is applied to your vehicle on the label located inside of the hood.

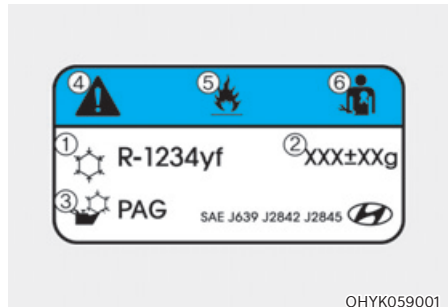

Each symbols and specification on the air conditioning refrigerant label is represented as below:



1. Classification of refrigerant
2. Amount of refrigerant
3. Classification of compressor lubricant
4. Caution
5. Flammable refrigerant
6. To require registered technician to service air conditioning system

## WINDSHIELD DEFROSTING AND DEFOGGING



### WARNING

#### Windshield heating

Do not use the  position during cooling operation in extremely humid weather. The difference between the temperature of the outside air and that of the windshield could cause the outer surface of the windshield to fog up, causing loss of visibility could cause an accident resulting in serious injury or death. In this case, set the mode selection button to the  position and fan speed control knob to a lower speed.

- For maximum defrost performance, set the temperature control to the highest temperature setting and the fan speed control to the highest setting.
- If warm air to the floor is desired while defrosting or defogging, set the mode to the floor-defrost position.
- Before driving, clear all snow and ice from the windshield, rear window, side view mirrors, and all side windows.
- Clear all snow and ice from the hood and air inlet in the cowl grill to improve heater and defroster efficiency and to reduce the probability of fogging up the inside of the windshield.

### NOTICE

If the engine temperature is still cold after starting, then a brief engine warm up period may be required for the vented air flow to become warm or hot.

### To Defog Inside Windshield

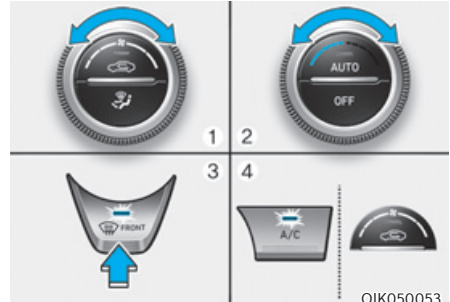

1. Select the desired fan speed.
2. Select the desired temperature.
3. Press the defroster button ().
4. Fresh mode will be selected automatically.

Check to make sure the air intake control is in Fresh mode. If the air intake control indicator light is illuminated, press the button once to enable Fresh mode (indicator light OFF).

If the () position is selected, the fan speed is automatically increased.

## To Defrost Inside Windshield

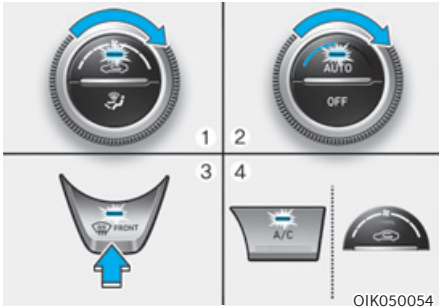

1. Set the fan speed to the highest (extreme right) position.
2. Set the temperature to the extreme hot (HI) position.
3. Press the defroster button (☼).
4. Fresh mode will be selected automatically.

Check to make sure the air intake control is in Fresh mode. If the air intake control indicator light is illuminated, press the button once to enable Fresh mode (indicator light OFF).

If the (☼) position is selected, lower fan speed is adjusted to a higher fan speed.

## Defogging Logic

To reduce the probability of fogging up the inside of the windshield, the air intake or air conditioning are controlled automatically according to certain conditions such as (☼) positions. To cancel or reset the defogging logic, do the following.

1. Press the Engine Start/Stop button to the ON position.
2. Press the defroster button (☼) or (☼).
3. While pressing the air conditioning button (A/C), press the air intake control button at least 5 times within 3 seconds.

The air intake control button indicator will blink 3 times to indicate that the defogging logic has been disabled. Repeat the steps again to re-enable the defogging logic.

If the battery has been discharged or disconnected, it resets to the defog logic status.

## Rear Window Defroster

### NOTICE

To prevent damage to the rear window defroster conducting elements bonded to the inside surface of the rear window, never use sharp instruments or window cleaners containing abrasives to clean the window.



OIK050093

The defroster heats the window to remove frost, fog and thin ice from the interior and exterior of the rear window, while the engine is running.

- To activate the rear window defroster, press the rear window defroster button located in the center control panel. The indicator on the rear window defroster button illuminates when the defroster is ON.
- To turn off the defroster, press the rear window defroster button again.

### **i** Information

- If there is heavy accumulation of snow on the rear window, brush it off before operating the rear defroster.
- The rear window defroster automatically turns off after approximately 20 minutes or when the Engine Start/Stop button is in the OFF position.

### **Side view mirror defroster**

If your vehicle is equipped with the side view mirror defrosters, they will operate at the same time you turn on the rear window defroster.



## CLIMATE CONTROL ADDITIONAL FEATURES

### Auto Defogging System

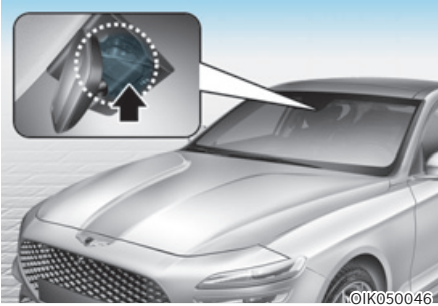

Auto defogging helps reduce the possibility of fogging up the inside of the windshield by automatically sensing the moisture on inside the windshield.

The auto defogging system operates when the heater or air conditioning is on.

#### **i** Information

**The auto defogging system may not operate normally, when the outside temperature is below 14 °F (-10 °C).**



When the Auto Defogging System operates, the indicator will illuminate.

If a high amount of humidity is detected in the vehicle, the Auto Defogging System will be enabled. The following steps will be performed automatically:

- Step 1) Operating the air conditioning.
- Step 2) Outside air position.
- Step 3) Blowing air flow toward the windshield.
- Step 4) Increasing air flow toward the windshield (Step could be changed according to the outside temperature)

If the air conditioning is off or recirculation mode is manually selected while Auto Defogging System is ON, the Auto Defogging System indicator will blink 3 times to signal that the manual operation has been canceled.

## Turning the Auto Defogging System ON or OFF

### Climate control system

Press the front windshield defroster button for 3 seconds when the Engine Start/Stop button is in the ON position. When the Auto Defogging System is turned off, the ADS OFF symbol will blink 3 times and ADS OFF will be displayed on the climate control information screen.

When the Auto Defogging System is turned on, the ADS OFF symbol will blink 6 times without a signal.

### Infotainment system

Auto Defogging System can be turned on and off by selecting 'Setup → Vehicle Settings → Climate → Defog/Defrost Options → Auto Defog' from the infotainment system screen.

**See additional information in supplied Infotainment Manual.**

## **i** Information

- **When the air conditioning is turned on by Auto Defogging System, if you try to turn off the air conditioning, the indicator will blink 3 times and the air conditioning will not be turned off.**
- **To maintain the effectiveness and efficiency of the Auto Defogging System, do not select Recirculation mode while the system is operating.**
- **When Auto Defogging System is operating, fan speed adjustment, temperature adjustment, and air intake control selection are all disabled.**

## **NOTICE**

**Do not remove the sensor cover located on the upper end of the windshield glass.**

**Damage to system parts could occur and may not be covered by your vehicle warranty.**

## Automatic Ventilation (if equipped)

To increase cabin air quality and help reduce windshield misting, Recirculation mode switches off automatically after 30 minutes or over, depending on the outside temperature, and the air intake will change to Fresh mode.

## Turning Automatic Ventilation ON or OFF

### Climate control system

To turn the Automatic Ventilation feature on or off, when the climate control system is on, select Face level (👤) mode and press the air intake control (🚗) button at least five times within three seconds while pressing the A/C button. When Automatic Ventilation is turned on, the air intake control button indicator will blink 6 times. When turned off, the indicator will blink 3 times.

### Infotainment system

Automatic Ventilation can be turned on and off by selecting 'Setup → Vehicle Settings → Climate → Automatic Ventilation Auto Dehumidify' from the infotainment system screen.



**See additional information in supplied Infotainment Manual.**

### Recirculating Air when Washer Fluid is Used

Recirculation mode automatically activates to reduce any objectionable scent of the washer fluid from entering the cabin when the windshield washer is used.

#### **Turning Activate upon Washer Fluid Use ON or OFF**

##### Climate control system

To turn the Activate upon Washer Fluid Use feature on or off, select Floor level () mode, and then press the air intake control () button four times within two seconds while pressing the A/C icon.

When Activate upon Washer Fluid Use ON is turned on, the air intake control button indicator will blink 6 times. When turned off, the indicator will blink 3 times.

##### Infotainment system

Activate upon Washer Fluid Use can be turned on and off by selecting 'Setup → Vehicle Settings → Climate → Recirculate Air → Activate upon Washer Fluid Use (or Interlocking washer fluid)' from the infotainment system screen.

#### **See additional information in supplied Infotainment Manual.**

However, in cold weather to help prevent the windshield from fogging up, the recirculation mode may not be selected.

### Sunroof Inside Air Recirculation (if equipped)

When the sunroof is opened, fresh mode will be automatically selected. At this time, if you press the air intake control button, recirculation mode will be selected but will change back to fresh mode after 3 minutes. When the sunroof is closed, the air intake position will return to the original position that was selected.

## STORAGE COMPARTMENT



### WARNING

Never store cigarette lighters, propane cylinders, or other flammable/explosive materials in the vehicle. These items may catch fire and/or explode if the vehicle is exposed to hot temperatures for extended periods.



### WARNING

**ALWAYS** keep the storage compartment covers closed securely while driving. Items inside your vehicle are moving as fast as the vehicle. If you have to stop or turn quickly, or if there is a crash, the items may fly out of the compartment and may cause an injury if they strike the driver or a passenger.

### NOTICE

To avoid possible theft, do not leave valuables in the storage compartments.

## Center Console Storage

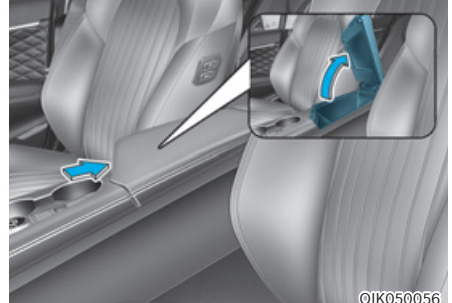

To open:  
Press the button.

## Glove Box

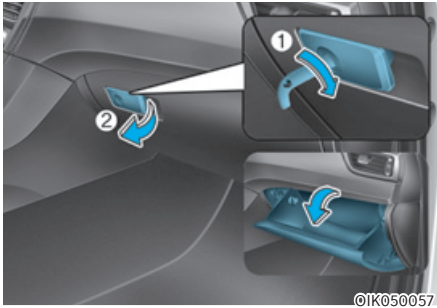

The glove box can be locked and unlocked with the mechanical key (1).

To open:

Pull the lever (1).



### WARNING

**ALWAYS** close the glove box door after use.

An open glove box door can cause serious injury to the passenger in an accident, even if the passenger is wearing a seat belt.

## Sunglass Holder

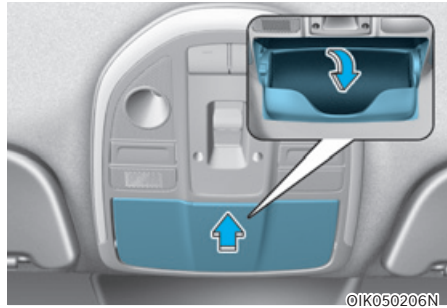

To open:

Push and release the cover and the holder will slowly open. Place your sunglasses in the compartment door with the lenses facing out.

To close:

Push back into position.

Make sure the sunglasses holder is closed while driving.



### WARNING

- Do not keep objects except sunglasses inside the sunglasses holder. Such objects can be thrown from the holder in the event of a sudden stop or an accident, possibly injuring the passengers in the vehicle.
- Do not open the sunglasses holder while the vehicle is moving. The rear view mirror of the vehicle can be blocked by an open sunglasses holder.
- Do not put the glasses forcibly into a sunglasses holder. It may cause personal injury if you try to open it forcibly when the glasses are jammed in holder.

## INTERIOR FEATURES

### Cup Holder

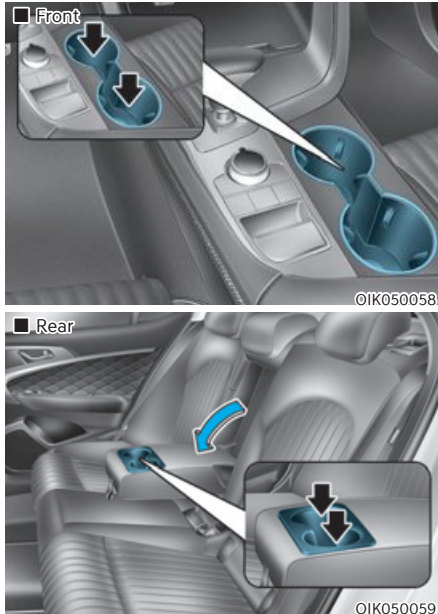

Cups or small beverages cups may be placed in the cup holders.

#### WARNING

- Avoid abrupt starting and braking when the cup holder is in use to prevent spilling your drink. If hot liquid spills, you could be burned. Such a burn to the driver could cause loss of vehicle control resulting in an accident.
- Do not place uncovered or unsecured cups, bottles, cans, etc., in the cup holder containing hot liquid while the vehicle is in motion. Injuries may result in the event of a sudden stop or collision.
- Only use soft cups in the cup holders. Hard objects can injure you in an accident.

#### WARNING

Keep cans or bottles out of direct sun light and do not put them in a hot vehicle. It may explode.

#### **NOTICE**

- Keep your drinks sealed while driving to prevent spilling your drink. If liquid spills, it may get into the vehicle's electrical/electronic system and damage electrical/electronic parts.
- When cleaning spilled liquids do not use hot air to blow out or dry the cup holder. This may damage the interior.

## Sunvisor

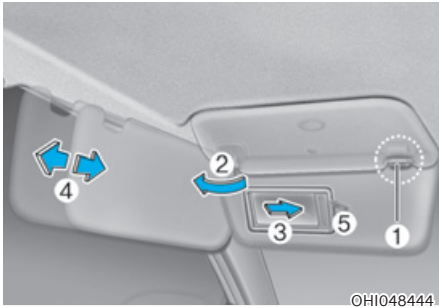

To use the sunvisor, pull it downward.

To use the sunvisor to block the sun from the side window, pull it downward, release it from the bracket (1) and swing it to the side (2) towards the window.

To use the vanity mirror, pull down the sunvisor and slide the mirror cover (3).

Adjust the sunvisor forward or backward (4) as needed (if equipped). Use the ticket holder (5) to hold tickets.

Close the vanity mirror cover securely and return the sunvisor to its original position after use.



### WARNING

For your safety, do not block your view when using the sunvisor.

### NOTICE

The tab (5) adjacent to the vanity mirror on the sunvisor can be used for toll road tickets or self parking tickets. Use caution when inserting tickets into the ticket holder to avoid damage. Refrain from putting several tickets in the ticket holder as this could also damage the retaining tab.

## Power Outlet

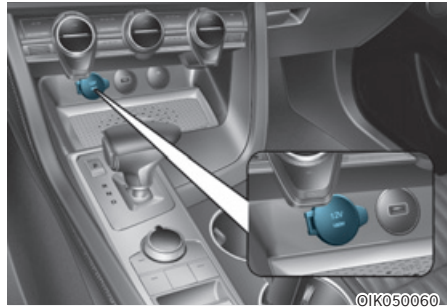

The power outlet is designed to provide power for mobile telephones or other devices designed to operate with vehicle electrical systems. The devices should draw less than 180 watts with the engine running.

## WARNING

Avoid electrical shocks. Do not place your fingers or foreign objects (pin, etc.) into a power outlet or touch the power outlet with a wet hand.

## NOTICE

To prevent damage to the Power Outlets:

- Use the power outlet only when the engine is running and remove the accessory plug after use. Using the accessory plug for prolonged periods of time with the engine off could cause the battery to discharge.
- Only use 12 volts electric accessories which are less than 180 watts in electric capacity.
- Adjust the air-conditioner or heater to the lowest operating level when using the power outlet.
- Close the cover when not in use.
- Some electronic devices can cause electronic interference when plugged into a vehicle's power outlet. These devices may cause excessive audio static and malfunctions in other electronic systems or devices used in your vehicle.
- Push the plug in as far as it will go. If good contact is not made, the plug may overheat and the fuse may open.
- Plug in battery equipped electrical/ electronic devices with reverse current protection. The current from the battery may flow into the vehicle's electrical/electronic system and cause system malfunction.

## USB Charger

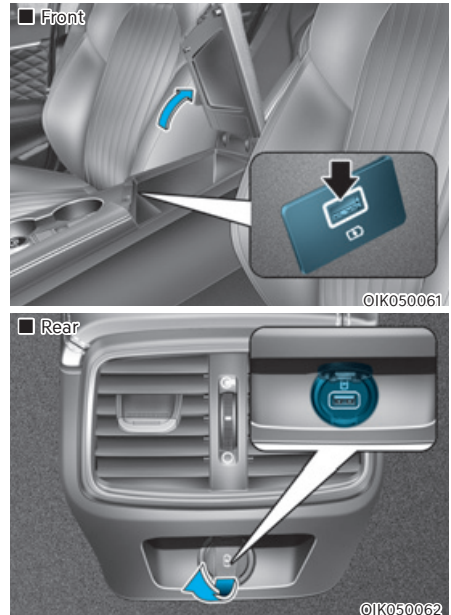

The USB charger is designed to recharge batteries of small size electrical devices using a USB cable.

The electrical devices can be recharged when the Engine Start/Stop button is in the ON or START position.

The battery charging state may be monitored on the electrical device.

Disconnect the USB cable from the USB port after use.



- A smart phone or a tablet PC may get warmer during the re-charging process. It does not indicate any malfunction with the charging system.
- A smart phone or a tablet PC, which adopts a different re-charging method, may not be properly re-charged. In this case, use an exclusive charger of your device.
- The charging terminal is only to recharge a device. Do not use the charging terminal either to turn ON an audio or to play media in the infotainment system.

### **NOTICE**

**Use the USB charger when the engine is running. Using USB charger for prolonged periods of time with the engine off could cause the battery to discharge.**

**To prevent damage to the USB charger:**

- Do not insert foreign objects or spill liquid into the outlet. The USB charging terminal may be damaged.
- Do not use devices with current consumption exceeding 2,100 mA (2.1 A).

## Wireless Smart Phone Charging System (if equipped)

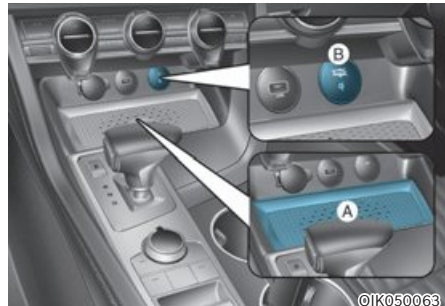

[A] : Charging pad, [B] : Indicator light

On certain models, the vehicle comes equipped with a wireless smart phone charger.

The system is available when all doors are closed, and when the Engine Start/ Stop button is in the ON or START position.

### Charging smart phone

The wireless smart phone charging system charges only the Qi-enabled smart phones (Qi). Read the label on the smart phone accessory cover or visit your smart phone manufacturer's website to check whether your smart phone supports the Qi technology.

The wireless charging process starts when you put a Qi-enabled smart phone on the wireless charging unit.

1. Remove other items, including the smart key, from the wireless charging unit. If not, the wireless charging process may be interrupted. Place the smart phone on the center of the charging pad.
2. The indicator light is orange when the smart phone is charging. The indicator light will turn blue when phone charging is complete.
3. You can turn ON or OFF the wireless charging function from the Settings menu in the infotainment system screen. Select:
  - Setup → Vehicle → Convenience → Wireless Charging

If your smart phone is not charging:

- Slightly change the position of the smart phone on the charging pad.
- Make sure the indicator light is orange.

The indicator light will blink orange for 10 seconds if there is a malfunction in the wireless charging system.

In this case, temporarily stop the charging process, and re-attempt to charge your smart phone.

The system warns you with a message on the LCD display if the smart phone is still on the wireless charging unit after the vehicle is turned OFF and the front door is opened.

- High speed wireless charging can be activated only when the cellular phones equipped with a wireless charging function is on the charging pad.
- During wireless charging, the internal fan operates to prevent the charging pad from becoming hot. This may cause fan noise.

### Information

**For some manufacturer's smart phones, the system may not warn you even though the smart phone is left on the wireless charging unit. This is due to the particular characteristic of the smart phone and not a malfunction of the wireless charging.**

### NOTICE

- The wireless smart phone charging system may not support certain smart phones, which are not verified for the Qi specification (Qi).
- When placing your smart phone on the charging pad, position the phone in the middle of the mat for optimal charging performance. If your smart phone is off to the side, the charging rate may be less and in some cases the smart phone may experience higher heat conduction. Also, the warning message and warning sounds in the cluster may not appear.
- In some cases, the wireless charging may stop temporarily when the Smart Key is used, either when starting the vehicle or locking/unlocking the doors, etc.
- When charging certain smart phones, the charging indicator may not change to blue when the smart phone is fully charged.
- The wireless charging process may temporarily stop, when temperature abnormally increases inside the wireless smart phone charging system. The wireless charging process restarts, when temperature falls to a certain level.
- The wireless charging process may temporarily stop when there is any metallic item, such as a coin, between the wireless smart phone charging system and the smart phone.
- When charging some smart phones with a self-protection feature, the wireless charging speed may decrease and the wireless charging may stop.
- If the smart phone has a thick cover, the wireless charging may not be possible.

- If the smart phone is not completely contacting the charging pad, wireless charging may not operate properly.
- Some magnetic items like credit cards, phone cards or rail tickets may be damaged if left with the smart phone during the charging process. Also, the warning message and warning sounds in the cluster may not appear.
- When any smart phone without a wireless charging function or a metallic object is placed on the charging pad, a small noise may sound. This small sound is due to the vehicle discerning compatibility of the object placed on the charging pad. It does not affect your vehicle or the smart phone in any way.

### Information

If the Engine Start/Stop button is in the OFF position, the charging also stops.

### Information

This device complies with Part 15 of the FCC rules.

Operation is subject to the following three conditions:

1. This device may not cause harmful interference, and
2. This device must accept any interference received, including interference that may cause undesired operation.
3. Changes or modifications not expressly approved by the party responsible for compliance could void the user's authority to operate the device.

## Clock

The clock can be set from the infotainment system.

See additional information in supplied Infotainment Manual.



### WARNING

Do not attempt to adjust the clock while driving. Doing so may result in distracted driving which may lead to an accident involving personal injury or death.

## Coat Hook

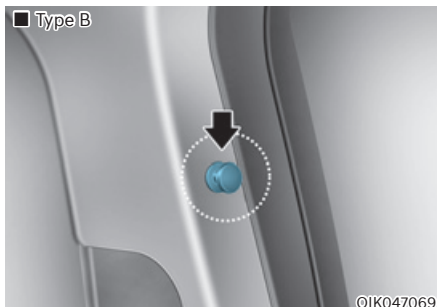
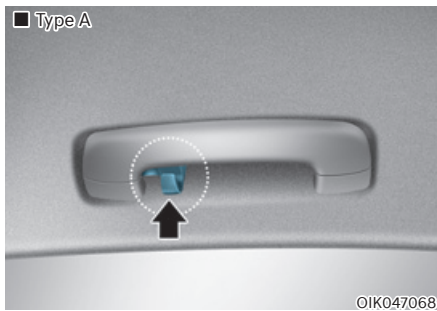

These hooks are not designed to hold large or heavy items.



### WARNING

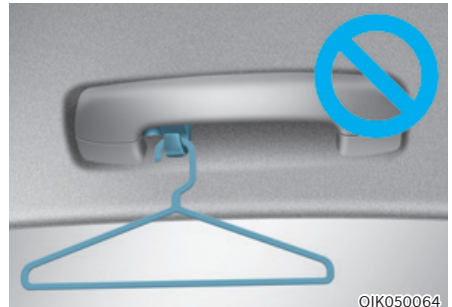

Do not hang other objects such as hangers or hard objects except clothes. Also, do not put heavy, sharp or breakable objects in the clothes pockets. In an accident or when the curtain air bag is inflated, it may cause vehicle damage or personal injury.

## Floor Mat Anchor(s)

ALWAYS use the Floor Mat Anchors to attach the front floor mats to the vehicle. The anchors on the front floor carpet keep the floor mats from sliding forward.



### WARNING

Do not overlay additional mats or liners over the floor mats. If using All Weather mats, remove the carpeted floor mats before installing them. Only use floor mats designed to connect to the anchors.



## WARNING

The following must be observed when installing ANY floor mat to the vehicle.

- Ensure to remove a protective film attached on the carpet before attaching a floor mat on the front floor carpet. Otherwise, the floor mat may move freely on the protective film and it could result in unintentional braking or accelerating.
- Ensure that the floor mats are securely attached to the vehicle's floor mat anchor(s) before driving the vehicle.
- Do not use ANY floor mat that cannot be firmly attached to the vehicle's floor mat anchors.
- Do not stack floor mats on top of one another (e.g. all-weather rubber mat on top of a carpeted floor mat). Only a single floor mat should be installed in each position.

**IMPORTANT** Your vehicle was manufactured with driver's side floor mat anchors that are designed to securely hold the floor mat in place. To avoid any interference with pedal operation, Genesis Branded Vehicle recommends that the Genesis floor mat designed for use in your vehicle be installed.

## Luggage Net Holder (if equipped)



To keep items from shifting in the luggage compartment, you can use the 4 holders located in the luggage board to attach the luggage net.

Make sure the luggage net is securely attached to the holders in the luggage board.

If necessary, we recommend that you contact your authorized retailer of Genesis Branded products to obtain a luggage net.



## WARNING

**Avoid eye injury. DO NOT overstretch the luggage net. ALWAYS keep your face and body out of the luggage net's recoil path. DO NOT use the luggage net when the strap has visible signs of wear or damage.**

**Use the luggage net to keep only light items from shifting in the luggage compartment.**

## INFOTAINMENT SYSTEM

### NOTICE

- If you install an aftermarket HID head lamp, your vehicle's audio and electronic devices may not function properly.
- Prevent chemicals such as perfume, cosmetic oil, sun cream, hand cleaner, and air freshener from contacting the interior parts because they may cause damage or discoloration.

### USB Port

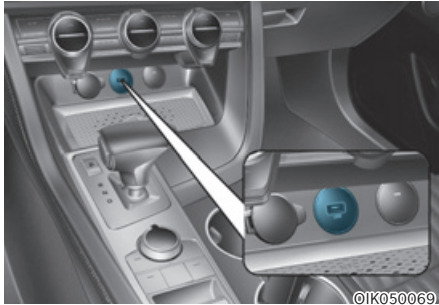

You can use a USB cable to connect audio devices to the vehicle USB port.

### **i** Information

When using a portable audio device connected to the power outlet, noise may occur during playback. If this happens, use the portable audio device's power source.

### Antenna

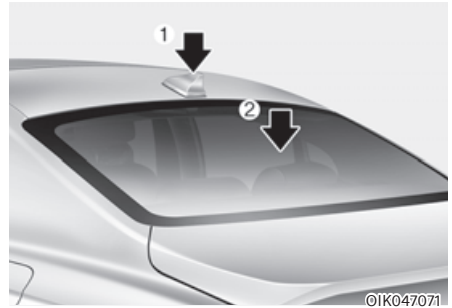

#### **Shark fin antenna (1, if equipped)**

The shark fin antenna receives transmitted data. (for example: SXM, GPS, LTE)

#### **Glass antenna (2)**

Your vehicle uses a glass antenna to receive both AM and FM signals.

- \* However, the signals which the antenna can transmit and receive varies depending on the vehicle option.

## Steering Wheel Remote Controls

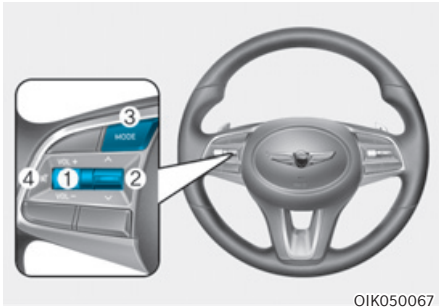

### NOTICE

Do not operate multiple audio remote control buttons simultaneously.

#### VOLUME (VOL + / VOL -) (1)

- Rotate the VOLUME scroll up to increase volume.
- Rotate the VOLUME scroll down to decrease volume.

#### SEEK/PRESET (∧ / ∨) (2)

If the SEEK/PRESET switch is pressed up or down and held for 0.8 second or more, it will function in the following modes:

- **RADIO mode**  
It will function as the AUTO SEEK select button. It will SEEK until you release the button.
- **MEDIA mode**  
It will function as the FF/RW button.

If the SEEK/PRESET switch is pressed up or down, it will function in the following modes:

- **RADIO mode**  
It will function as the PRESET STATION UP/DOWN button.
- **MEDIA mode**  
It will function as the TRACK UP/DOWN button.

#### MODE (3)

Press the MODE button to toggle through Radio or Media modes.

#### MUTE (🔇) (4)

- Press the MUTE button to mute the sound.
- Press the MUTE button again to activate the sound.

See additional information in supplied Infotainment Manual.

## Infotainment System



See additional information in supplied Infotainment Manual.

## Voice Recognition

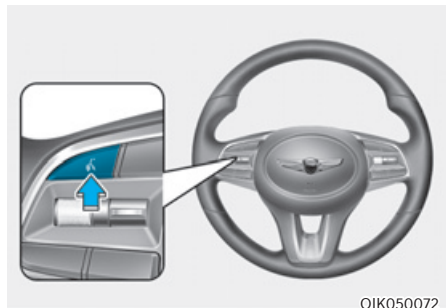

See additional information in supplied Infotainment Manual.

## Bluetooth® Wireless Technology

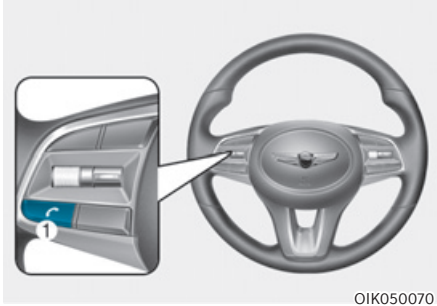

OIK050070



©IK050095N

- (1) Call / Answer / Call end button
- (2) Microphone

See additional information in supplied Infotainment Manual.

### CAUTION

To avoid driver distractions, do not excessively operate the device while driving the vehicle which may lead to an accident.

## Lexicon Premium Sound System (if equipped)

### CAUTION

Lexicon premium sound system is equipped with door speaker grills made of stainless steel. The grill surface can be heated when the vehicle is exposed to hot weather for a long period of time. Keep away from the speaker grill when it is hot.



# 6. Driving Your Vehicle

Before Driving .....	6-4
Before Entering the Vehicle.....	6-4
Before Starting .....	6-4
Engine Start/Stop Button .....	6-5
Engine Stop/Start Button Positions .....	6-6
Starting the Engine .....	6-7
Turning Off the Engine.....	6-8
Remote Start.....	6-8
Automatic transmission .....	6-9
Automatic Transmission Operation.....	6-9
Paddle Shifter (Manual shift mode).....	6-14
LCD Display Messages.....	6-15
Good Driving Practices .....	6-18
Braking System .....	6-20
Power-Assist Brakes .....	6-20
High Performance Brake.....	6-21
Disc Brakes Wear Indicator.....	6-21
Electronic Parking Brake (EPB).....	6-22
Auto Hold .....	6-26
Anti-Lock Brake System (ABS).....	6-30
Electronic Stability Control (ESC) .....	6-31
Vehicle Stability Management (VSM) .....	6-34
Hill-Start Assist Control (HAC).....	6-35
Good Braking Practices .....	6-35
All Wheel Drive (AWD) .....	6-36
For Safe AWD Operation.....	6-37
Emergency Precautions.....	6-38
Limited Slip Differential.....	6-40
Electronic Control Suspension.....	6-40
System Malfunction .....	6-40
Launch Control.....	6-41
Prerequisite for Activation .....	6-41
Launch Control Activation .....	6-41
Limited Use of Launch Control.....	6-42
Coasting .....	6-43
Coasting Setting.....	6-43
Coasting Operating Conditions.....	6-43
Coasting Release Conditions .....	6-44

Drive Mode Integrated Control System.....	6-45
Drive mode .....	6-45
Vehicle Characteristic .....	6-47
Special Driving Conditions .....	6-48
Hazardous Driving Conditions .....	6-48
Rocking the Vehicle .....	6-48
Smooth Cornering.....	6-49
Driving at Night .....	6-49
Driving in the Rain.....	6-49
Driving in Flooded Areas.....	6-50
Highway Driving.....	6-50
Winter Driving .....	6-51
Snow or Icy Conditions .....	6-51
Winter Precautions.....	6-54
Vehicle Load Limit .....	6-56
The Loading Information Label .....	6-57
Trailer Towing .....	6-61

**WARNING**

**Carbon monoxide (CO) gas is toxic. Breathing CO can cause unconsciousness and death.**

Engine exhaust contains carbon monoxide which cannot be seen or smelled.

**Do not inhale engine exhaust.**

If at any time you smell engine exhaust inside the vehicle, open the windows immediately. Exposure to CO can cause unconsciousness and death by asphyxiation.

**Be sure the exhaust system does not leak.**

The exhaust system should be checked whenever the vehicle is raised to change the oil or for any other purpose. If you hear a change in the sound of the exhaust or if you drive over something that strikes the underneath side of the vehicle, have the exhaust system checked as soon as possible by an authorized retailer of Genesis Branded products.

**Do not run the engine in an enclosed area.**

Letting the engine idle in your garage, even with the garage door open, is a hazardous practice. Run the engine only long enough to start the engine and to move the vehicle out of the garage.

**Avoid idling the engine for prolonged periods with people inside the vehicle.**

If it is necessary to idle the engine for a prolonged period with people inside the vehicle, be sure to do so only in an open area with the air intake set at “Fresh” and fan control set to high so fresh air is drawn into the interior.

**Keep the air intakes clear.**

To assure proper operation of the ventilation system, keep the ventilation air intakes located in front of the windshield clear of snow, ice, leaves, or other obstructions.

**If you must drive with the trunk open:**

Close all windows.

Open instrument panel air vents.

Set the air intake control at “Fresh”, the air flow control at “Floor” or “Face”, and the fan control set to high.

**WARNING****CALIFORNIA PROPOSITION 65 WARNING**

**Engine exhaust and a wide variety of automobile components including components found in the interior furnishings in a vehicle, contain or emit harmful chemicals known to the State of California to cause cancer and birth defects and reproductive harm. In addition, certain fluids contained in vehicles and certain products of components contain or emit chemicals known to the State of California to cause cancer and birth defects or other reproductive harm.**

## BEFORE DRIVING

### Before Entering the Vehicle

- Be sure all windows, outside mirror(s), and outside lights are clean and unobstructed.
- Remove frost, snow, or ice.
- Visually check the tires for uneven wear and damage.
- Check under the vehicle for any sign of leaks.
- Be sure there are no obstacles behind you if you intend to back up.

### Before Starting

- Make sure the hood, the trunk, and the doors are securely closed and locked.
- Adjust the position of the seat and steering wheel.
- Adjust the inside and side view mirrors.
- Verify all the lights work.
- Fasten your seat belt. Check that all passengers have fastened their seat belts.
- Check the gauges and indicators in the instrument panel and the messages on the instrument display when the ignition switch is in the ON position.
- Check that any items you are carrying are stored properly or fastened down securely.



### WARNING

To reduce the risk of **SERIOUS INJURY** or **DEATH**, take the following precautions:

- **ALWAYS** wear your seat belt. All passengers must be properly belted whenever the vehicle is moving. For more information, refer to “Seat Belts” section in chapter 3.
- Always drive defensively. Assume other drivers or pedestrians may be careless and make mistakes.
- Stay focused on the task of driving. Driver distraction can cause accidents.
- Leave plenty of space between you and the vehicle in front of you.



### WARNING

**NEVER** drink or take drugs and drive.

Drinking or taking drugs and driving is dangerous and may result in an accident and **SERIOUS INJURY** or **DEATH**.

Drunk driving is the number one contributor to the highway death toll each year. Even a small amount of alcohol will affect your reflexes, perceptions and judgment. Just one drink can reduce your ability to respond to changing conditions and emergencies and your reaction time gets worse with each additional drink.

Driving while under the influence of drugs is as dangerous or more dangerous than driving under the influence of alcohol.

You are much more likely to have a serious accident if you drink or take drugs and drive. If you are drinking or taking drugs, don't drive. Do not ride with a driver who has been drinking or taking drugs. Choose a designated driver or call a taxi.

## ENGINE START/STOP BUTTON



Whenever the front door is opened, the Engine Start/Stop button will illuminate and will go off 30 seconds after the door is closed.

### WARNING

To turn the vehicle off in an emergency: Press and hold the Engine Start/Stop button for more than two seconds OR Rapidly press and release the Engine Start/ Stop button three times (within three seconds).

If the vehicle is still moving, you can restart the vehicle without depressing the brake pedal by pressing the Engine Start/Stop button with the gear in the N (Neutral) position.

### WARNING

- NEVER press the Engine Start/Stop button while the vehicle is in motion except in an emergency. This will result in the vehicle turning off and loss of power assist for the steering and brake systems. This may lead to loss of directional control and braking function, which could cause an accident.
- Before leaving the driver's seat, always make sure the vehicle is in P (Park), apply the parking brake, press the Engine Start/ Stop button to the OFF position, and take the Smart Key with you. Unexpected vehicle movement may occur if these precautions are not followed.
- NEVER reach through the steering wheel for the Engine Start/Stop button or any other control while the vehicle is in motion. The presence of your hand or arm in this area may cause a loss of vehicle control resulting in an accident.

## Engine Stop/Start Button Positions

Button Position	Action	Notes
<b>OFF</b>	To turn off the engine, press the Engine Start/Stop button with the vehicle shifted to P (Park). Note if the Engine Start/Stop button is pressed with the vehicle shifted to D (Drive) or R (Reverse), the gear will automatically shift to P (Park). If the Engine Start/Stop button is pressed with the gear shifted to N (Neutral), the Engine Start/Stop button will change to the ACC position. The steering wheel locks to protect the vehicle from theft.	If the steering wheel is not locked properly when you open the driver's door, the warning chime will sound.
<b>ACC</b>	Press the Engine Start/Stop button when the button is in the OFF position without depressing the brake pedal. Some of the electrical accessories are usable. The steering wheel unlocks.	<ul style="list-style-type: none"> <li>• If you leave the Engine Start/Stop button in the ACC position for more than one hour, the battery power will turn off automatically to prevent the battery from discharging.</li> <li>• If the steering wheel doesn't unlock properly, the Engine Start/Stop button will not work. Press the Engine Start/Stop button while turning the steering wheel right and left to release.</li> </ul>
<b>ON</b>	Press the Engine Start/Stop button while it is in the ACC position without depressing the brake pedal. The warning lights can be checked before the engine is started.	Do not leave the Engine Start/Stop button in the ON position when the engine is not running to prevent the battery from discharging.
<b>START</b>	To start the engine, depress the brake pedal and press the Engine Start/ Stop button with the gear shifted to the P (Park) or the N (Neutral) position. For your safety, start the engine with the gear shifted to the P (Park) position.	If you press the Engine Start/Stop button without depressing the brake pedal, the engine does not start and the Engine Start/Stop button changes as follows: <b>OFF → ACC → ON → OFF or ACC</b>

## Starting the Engine

### WARNING

- Always wear appropriate shoes when operating your vehicle. Unsuitable shoes, such as high heels, ski boots, sandals, flip flops, etc., may interfere with your ability to use the brake and accelerator pedals.
- Do not start the vehicle with the accelerator pedal depressed.  
The vehicle can move which can lead to an accident.
- Wait until the engine RPM is normal. The vehicle may suddenly move if the brake pedal is released when the RPM is high.

### Information

- The vehicle will start by pressing the Engine Start/Stop button, only when the smart key is in the vehicle.
- Even if the smart key is in the vehicle, and when it is far away from the driver, the engine may not start.
- When the Engine Start/Stop button is in the ACC or ON position, if any door is open, the system checks for the smart key. When the smart key is not in the vehicle, the “” indicator will blink and the warning 'Key not in vehicle' will come on. When all doors are closed, the chime will also sound for about 5 seconds. Keep the smart key in the vehicle.

## Starting the gasoline engine

1. Always carry the smart key with you.
2. Make sure the parking brake is applied.
3. Make sure the gear is shifted to P (Park) by pressing the P button.
4. Depress the brake pedal.
5. Press the Engine Start/Stop button.

### Information

- Do not wait for the engine to warm up while the vehicle remains stationary. Start driving at moderate engine speeds. Steep accelerating and decelerating should be avoided.
- Always start the vehicle with your foot on the brake pedal. Do not depress the accelerator while starting the vehicle. Do not race the engine while warming it up.



### Information

If the smart key battery is weak or the smart key does not work correctly, you can start the engine by pressing the Engine Start/Stop button with the smart key in the direction of the picture above.

### Turning Off the Engine

1. Stop the vehicle and depress the brake pedal fully.
2. Press the P button to shift to P (Park).
3. Press the Engine Start/Stop button to the OFF position and apply the parking brake.

### Remote Start



You can start the vehicle using the Remote Start button of the smart key.

To start the vehicle remotely:

1. Press the door lock button within 32 feet (10 m) from the vehicle.
  2. Press the remote start ( $\Omega_{\text{HOLD}}$ ) button for over 2 seconds within 4 seconds after locking the doors. The hazard warning lights will blink.
  3. To turn off the remote start function, press the remote start ( $\Omega_{\text{HOLD}}$ ) button once.
- The remote start ( $\Omega_{\text{HOLD}}$ ) button may not operate if the smart key is not within 32 feet (10 m).
  - The vehicle will not remotely start if the engine hood or trunk is opened.
  - The vehicle must be in P (Park) for the remote start function to start.
  - The engine turns off if you get in the vehicle without a registered smart key.
  - The engine turns off if you do not get in the vehicle within 10 minutes after remotely starting the vehicle.
  - Do not idle the engine for a long period.



## AUTOMATIC TRANSMISSION



OIK057003

When you move the shift lever, depress the brake pedal while pressing the UNLOCK button.

### Automatic Transmission Operation

The automatic transmission has eight forward speeds and one reverse speed. The individual speeds are selected automatically in the D (Drive) position.



## WARNING

To reduce the risk of serious injury or death:

- **ALWAYS** check the surrounding areas near your vehicle for people, especially children, before shifting a vehicle into D (Drive) or R (Reverse).
- Before leaving the driver's seat, always make sure the vehicle is shifted to the P (Park) position, then apply the parking brake, then press the Engine Start/Stop button to the OFF position. Unexpected and sudden vehicle movement can occur if these precautions are not followed.
- When using the paddle shifter (manual shift mode), do not use engine braking (shifting from a high gear to lower gear) rapidly on slippery roads. The vehicle may slip causing an accident.

### Transmission ranges

The indicator in the instrument cluster displays the gear position when the Engine Start/Stop button is in the ON position.

However, if the gear is in N (Neutral) or P (Park), the position is displayed on the instrument cluster when the Engine Start/Stop button is in the OFF or ACC position.

### P (Park)

Always come to a complete stop before shifting into P (Park).



To shift the gear to P (Park), press the P button while depressing the brake pedal.

If you turn the engine off in R (Reverse) or D (Drive), the gear will automatically shift to P (Park).



## WARNING

- **Shifting into P (Park) while the vehicle is in motion may cause you to lose control of the vehicle.**
- **After the vehicle has stopped, always make sure the vehicle is in P (Park), apply the parking brake, and turn the engine off.**
- **When parking on an incline, shift the gear to P (Park) and apply the parking brake to prevent the vehicle from rolling downhill.**

## R (Reverse)

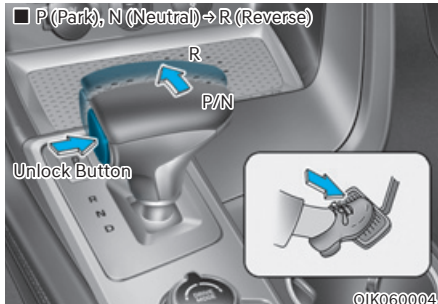

Use this position to drive the vehicle rearward.

To move the shift lever to R (Reverse), press the [UNLOCK] button while depressing the brake pedal and then move the shift lever forward.

## N (Neutral)



The wheels and transmission are not engaged.

Use N (Neutral) if you need to restart a stalled engine.

Shift into P (Park) if you need to leave your vehicle for any reason.

Always depress the brake pedal when you are shifting from N (Neutral) to another gear.

In N (Neutral), if the driver attempts to turn off the engine, the transmission remains in the N (Neutral) position and the Engine Start/Stop button will be in the ACC position.

To turn off the engine from the ACC position, press the Engine Start/Stop button to the ON position, press the P button, and then press the Engine Start/Stop button to the OFF position.

When either the driver's door or the front passenger's door is opened with the Engine Start/Stop button in the ACC position and the shift lever in N (Neutral) position, the engine is automatically turned OFF and the transmission automatically changes to the P (Park) position.

 **WARNING**

- Do not shift into gear unless your foot is firmly on the brake pedal. Use the P (Park) position to idle a vehicle for an extended period of time. The wheels and the transmission are not engaged. While parking the vehicle with the engine running, depress the brake pedal or apply the parking brake.
- Do not drive with the shift lever in N (Neutral). Doing so may result in an accident because of a loss of engine braking and the transmission could be damaged.

**D (Drive)**

This is the normal driving position. The transmission will automatically shift through an 8-gear sequence, providing the best fuel economy and power.

For extra power when passing another vehicle or driving uphill, depress the accelerator pedal further until you feel the transmission downshift to a lower gear.

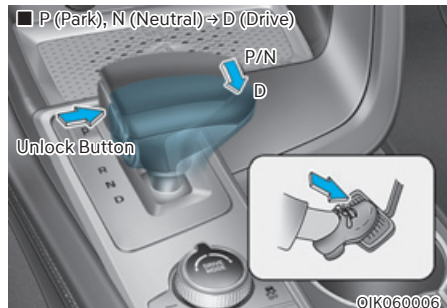
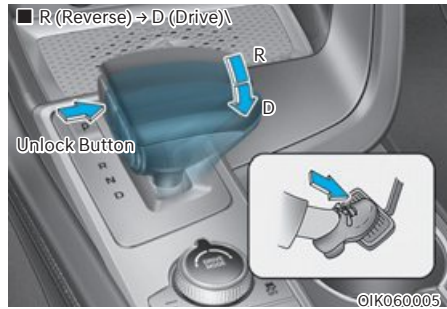

To shift into D (Drive), depress the brake pedal and press the [UNLOCK] button on the shift lever. Move the shift lever rearward.

To shift into D (Drive) from N (Neutral), you must depress the brake pedal.

**NOTICE**

**Always come to a complete stop before shifting into D (Drive).**

### Shift-lock system

For your safety, the automatic transmission has a shift-lock system which prevents shifting the transmission from P (Park) into R (Reverse) or D (Drive) unless the [UNLOCK] button is pressed while depressing the brake pedal.

To shift from P (Park) into R (Reverse) or D (Drive):

1. Depress and hold the brake pedal.
2. Start the engine or place the Engine Start/Stop button in the ON position.
3. Move the shift lever to R (Reverse) or D (Drive) while pressing the [UNLOCK] button.

### When the battery is discharged:

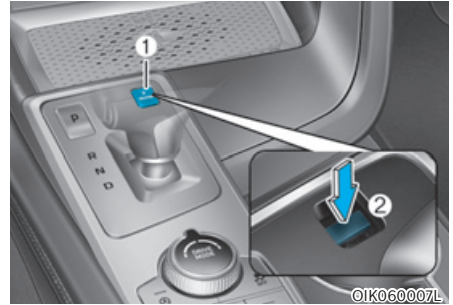

You cannot move the shift lever, when the battery is discharged.

In emergencies, do the following to move the shift lever to N (Neutral) on a level ground.

1. Connect the battery cables from another vehicle or from another battery to the jump-starting terminals inside the engine compartment.

#### **For more information refer to "Jump Starting" in chapter 8.**

2. Release the parking brake with the Engine Start/Stop button in the ON position.
3. Press the Engine Start/Stop button to the OFF position.
4. Remove the cap-cover (1) and press the P release button (2) while depressing the brake pedal. Then, the gear will change to the N (Neutral) position. The button (2) operates only for 20 seconds to change the gear between P (Park) and N (Neutral) from the time when the button (2) is first pressed.

### **i** Information

- In situations when the gear needs to be shifted from P (Park) to N (Neutral) when the Engine Start/Stop button is in the OFF position, refer to step 4.
- While the gear shifts to N (Neutral) or P (Park), you may hear mechanical noise which is a normal operating noise.

### Parking

Always come to a complete stop and continue to depress the brake pedal. Shift the vehicle into the P (Park) position, apply the parking brake, and place the Engine Start/Stop button in the OFF position. Take the Key with you when exiting the vehicle.



### WARNING

- **When you stay in the vehicle with the engine running, be careful not to depress the accelerator pedal for a long period of time. The engine or exhaust system may overheat and start a fire.**
- **The exhaust gas and the exhaust system are very hot. Keep away from the exhaust system components.**
- **Do not stop or park over flammable materials, such as dry grass, paper or leaves. They may ignite and cause a fire.**

### Paddle Shifter (Manual shift mode)

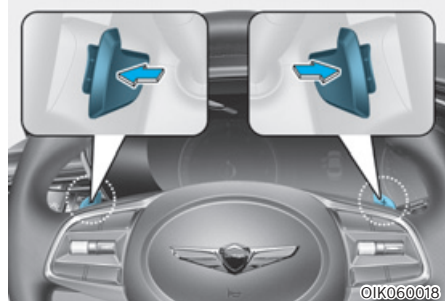

The paddle shifter is available when the shift lever is in the D (Drive) position.

Pull the [+] or [-] paddle shifter once to shift up or down one gear and the system changes from automatic shift mode to manual shift mode.

To change back to the automatic shift mode from manual shift mode, do one of the following:

- Move the shift lever down toward the D (Drive) position.
- Gently depress the accelerator pedal for more than 6 seconds.

However, if SPORT mode, SPORT+ mode, or CUSTOM mode (setting powertrain to SPORT or SPORT+) is selected, the paddle shifter will not change to automatic shift mode from manual shift mode.

- Drive the vehicle under 4mph (7 km/h).
- Pull and hold the right side paddle shifter.



### Information

**If the [+] and [-] paddle shifters are pulled at the same time, gear shift may not occur.**

## LCD Display Messages

### *Shifter system malfunction*

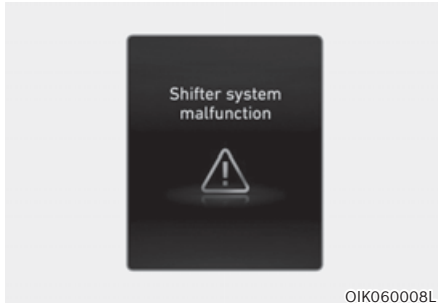

OIK060008L

The message appears on the LCD display when the transmission or the shift lever does not properly operate in the P (Park) position.

Immediately have the vehicle inspected by an authorized retailer of Genesis Branded products.

### *Check shift lever*

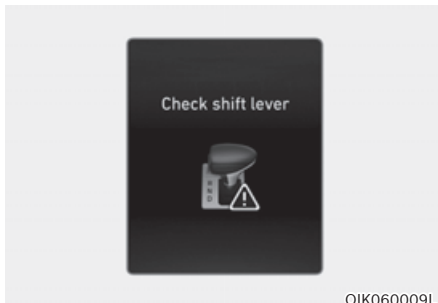

OIK060009L

The message appears on the LCD display when there is a malfunction with one of the key transmission shifter components.

Immediately have the vehicle inspected by an authorized retailer of Genesis Branded products.

### *Shifting conditions not met*

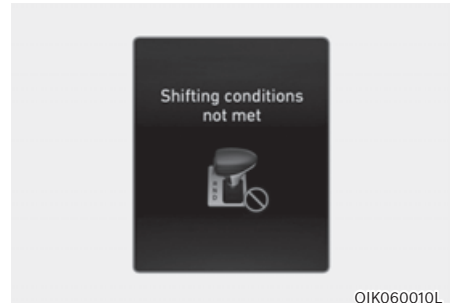

OIK060010L

The message appears on the LCD display when engine RPM is too high, or when driving speed is too fast to shift the gear. Decrease the vehicle speed or slow down before shifting the gear.

### *Press brake pedal to change gear*

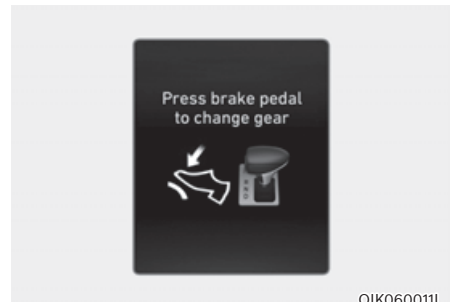

OIK060011L

The message appears on the LCD display when the brake pedal is not depressed while shifting the gear.

Depress the brake pedal and then shift the gear.

**Shift to P after stopping**



The message appears on the LCD display when the gear is shifted to P (Park) while the vehicle is moving. Stop the vehicle before shifting to P (Park).

**Press P for Park**



The message appears on the LCD display to inform the driver to press the P button to shift to P (Park) when the driver moves the shift lever upward even though the gear is in R (Reverse).

**Check P button**



The message appears on the LCD display when there is problem with the P button. Immediately have the vehicle inspected by an authorized retailer of Genesis Branded products.

**Press brake pedal, then press P RELEASE button**

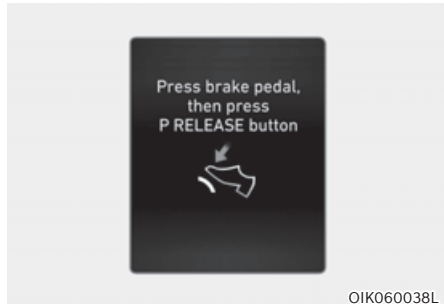

The message appears on the LCD display when the driver presses the PARK RELEASE button without depressing the brake pedal. Depress the brake pedal before pressing the P RELEASE button.

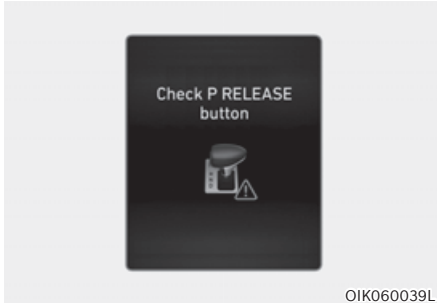

**Check P RELEASE button**

The message appears on the LCD display when there is problem with the P RELEASE button.

Immediately have the vehicle inspected by an authorized retailer of Genesis Branded products.

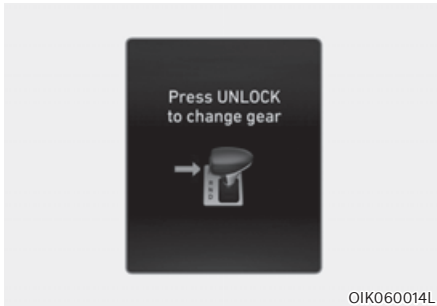
**Press UNLOCK to change gear**

The message appears on the LCD display when the [UNLOCK] button is not pressed while shifting the gear.

Press the [UNLOCK] button and then shift the gear.

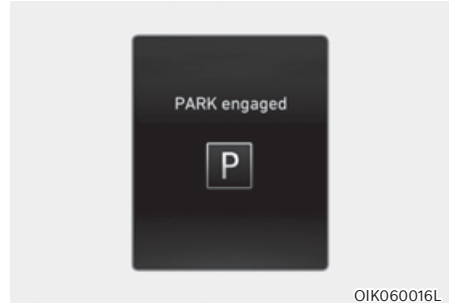
**PARK engaged**

The message appears on the LCD display when the P (Park) position is engaged.

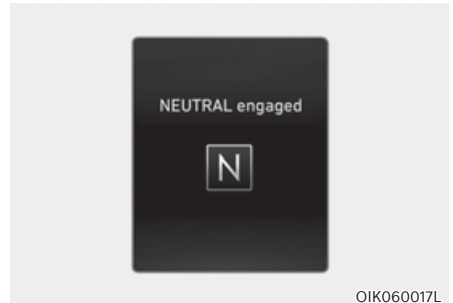
**NEUTRAL engaged**

The message appears on the LCD display when the N (Neutral) position is engaged.

### **Vehicle Power limited due to high transmission temperature**

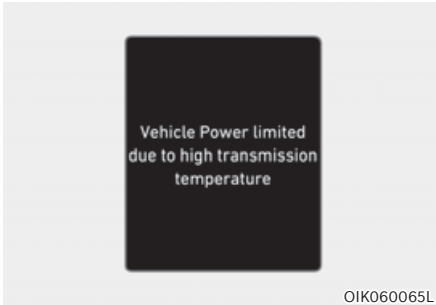

This message is displayed when the transmission oil temperature is high.

Drive at steady speed or stop the vehicle at a safe place with the engine on. When the oil temperature returns to normal, the message will disappear.

### **Good Driving Practices**

- Never shift the gear from P (Park) or N (Neutral) to any other position with the accelerator pedal depressed.
- Never shift the gear into P (Park) when the vehicle is in motion.

Be sure the vehicle is completely stopped before you attempt to shift into R (Reverse) or D (Drive).

- Do not shift the gear to N (Neutral) when driving. If the gear is shifted to N (Neutral) while driving, the vehicle loses the ability to provide engine braking. Doing so may increase the risk of an accident.

Also, shifting the gear back to D (Drive) while the vehicle is moving may severely damage the transmission.

- Driving uphill or downhill, always shift to D (Drive) when driving forward or to R (Reverse) when driving backwards, and check the gear position indicated on the cluster before driving. If the vehicle moves in the opposite direction of the selected gear, the engine may turn off and a serious accident may occur due to the degraded brake performance.
- Do not drive with your foot resting on the brake pedal. Even light, but consistent pedal pressure can result in the brakes overheating, brake wear and possibly even brake failure.

- Always apply the parking brake when leaving the vehicle. Do not depend on placing the transmission in P (Park) to keep the vehicle from moving.
- Exercise extreme caution when driving on a slippery surface. Be especially careful when braking, accelerating or shifting gears. On a slippery surface, an abrupt change in vehicle speed can cause the drive wheels to lose traction and may cause loss of vehicle control resulting in an accident
- Optimum vehicle performance and fuel economy is obtained by smoothly depressing and releasing the accelerator.



## WARNING

To reduce the risk of **SERIOUS INJURY** or **DEATH**:

- **ALWAYS wear your seat belt. In a collision, an unbelted occupant is significantly more likely to be seriously injured or killed than a properly belted occupant.**
- **Avoid high speeds when cornering or turning.**
- **Do not make quick steering wheel movements, such as sharp lane changes or fast, sharp turns.**
- **The risk of rollover is greatly increased if you lose control of your vehicle at highway speeds.**
- **Loss of control often occurs if two or more wheels drop off the roadway and the driver over steers to reenter the roadway.**
- **In the event your vehicle leaves the roadway, do not steer sharply. Instead, slow down before pulling back into the travel lanes.**
- **Genesis Branded Vehicle recommends you to follow all posted speed limits.**

## NOTICE

### Kickdown mechanism

Use the kickdown mechanism for maximum acceleration. Depress the accelerator pedal beyond the pressure point. The automatic transmission will shift to a lower gear depending on the engine speed.

## BRAKING SYSTEM

### Power-Assist Brakes

Your vehicle has power-assisted brakes that adjust automatically through normal usage.

If the engine is not running or is turned off while driving, the power assist for the brakes will not work. You can still stop your vehicle by applying greater force to the brake pedal than typical. The stopping distance, however, will be longer than with power brakes.

When the engine is not running, the reserve brake power is partially depleted each time the brake pedal is applied. Do not pump the brake pedal when the power assist has been interrupted.



### WARNING

Take the following precautions:

- **Do not drive with your foot resting on the brake pedal. This will create abnormal high brake temperatures, excessive brake lining and pad wear, and increased stopping distances.**
- **When descending down a long or steep hill, use the paddle shifter and manually downshift to a lower gear in order to control your speed without using the brake pedal excessively. Applying the brakes continuously will cause the brakes to overheat and could result in a temporary loss of braking performance.**
- **Wet brakes may impair the vehicle's ability to safely slow down; the vehicle may also pull to one side when the brakes are applied. Applying the brakes lightly will indicate whether they have been affected in this way. Always test your brakes in this fashion after driving through deep water. To dry the brakes, lightly tap the brake pedal to heat up the brakes while maintaining a safe forward speed until brake performance returns to normal. Avoid driving at high speeds until the brakes function correctly.**

## High Performance Brake (if equipped)

For vehicles equipped with the High Performance Brake (large-diameter Brembo brakes for enhanced braking performance), noise such as a squeal, squeak or groan is generated while braking. This is normal and the friction may create circle patterns on the disc surface. This is also a normal situation which does not affect braking performance.

### NOTICE

- **Occasional brake noise is normal. If a continuous grinding or continuous squeal sound is present, the brake lining may be worn-out. Have the vehicle checked by an authorized retailer of Genesis Branded products.**
- **If the vehicle has continuous vibration or shudder in the steering wheel while braking, have the vehicle be checked by an authorized retailer of Genesis Branded products.**



### WARNING

**Frequent speeding and braking may deform components and worn the disc brake causing vibration when braking. Prevent brake damage by avoiding excessive braking.**

**Brake wear, noise, vibration from excessive braking or deformation of the brakes caused by repeatedly braking in high speed, racing on tracks, etc. can be excluded from warranty coverage.**

## Disc Brakes Wear Indicator

When your brake pads are worn and new pads are required, you will hear a high pitched warning sound from your front or rear brakes. You may hear this sound come and go or it may occur whenever you depress the brake pedal.

Note that some driving conditions or climates may cause a brake squeal when you first apply (or lightly apply) the brakes. This is normal and does not indicate a problem with your brakes.

### NOTICE

**To avoid costly brake repairs, do not continue to drive with worn brake pads.**



### Information

**Always replace brake pads as complete front or rear axle sets.**

## Electronic Parking Brake (EPB)

### Applying the parking brake



To apply EPB (Electronic Parking Brake):

1. Depress and hold the brake pedal.
2. Pull up the EPB switch.

Make sure the Parking Brake warning light comes on.

EPB (Electronic Parking Brake) may be automatically applied when:

- Requested by other systems
- The driver turns the vehicle off while Auto Hold is operating.

### Emergency braking

If there is a problem with the brake pedal while driving, emergency braking is possible by pulling up and holding the EPB switch. Braking is possible only while you are holding the EPB switch. However, braking distance will be longer than normal.

### **WARNING**

To reduce the risk of **SERIOUS INJURY** or **DEATH**, do not operate the EPB while the vehicle is moving except in an emergency situation. It could damage the brake system and lead to an accident.

### **Information**

During emergency braking, the Parking Brake warning light will illuminate to indicate that the system is operating.

### **NOTICE**

If you continuously notice a noise or burning smell when the EPB is used for emergency braking, have the system checked by an authorized retailer of Genesis Branded products.

## Releasing the parking brake



### To release EPB (Electronic Parking Brake):

1. Press the Engine Start/Stop button to the ON or START position.
2. Press the EPB switch while depressing the brake pedal.

Make sure the Parking Brake warning light goes off.

### To release EPB (Electronic Parking Brake) automatically:

- Gear in P (Park)  
With the engine running depress the brake pedal and shift out of P (Park) to R (Reverse) or D (Drive).
- Gear in N (Neutral)  
With the engine running depress the brake pedal and shift out of N (Neutral) to R (Reverse) or D (Drive).

- Satisfy the following conditions
  1. Ensure seat belts are fastened and the doors, hood and trunk are closed.
  2. With the engine running, depress the brake pedal and shift out of P (Park) to R (Reverse), D (Drive) or Manual shift mode.
  3. Depress the accelerator pedal.  
Make sure the Parking Brake warning light goes off.

## **i** Information

- **For your safety, you can engage EPB even though the Engine Stop/Start button is in the OFF position (only if battery power is available), but you cannot release it.**
- **For your safety, depress the brake pedal and release the parking brake manually with the EPB switch when you drive downhill or when backing up the vehicle.**

## **NOTICE**

- **If the Parking Brake warning light is still on even though the EPB has been released, have the system checked by an authorized retailer of Genesis Branded products.**
- **Do not drive your vehicle with EPB applied. It may cause excessive brake pad and brake rotor wear.**

### Warning messages

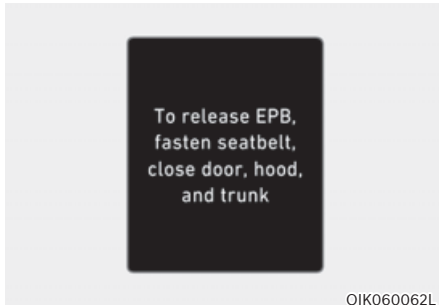

To release EPB, fasten seatbelt, close door, hood and trunk

- If you try to drive with EPB applied, a warning will sound and a message will appear.
- If the driver's seat belt is unfastened and the engine hood or trunk is opened, a warning will sound and a message will appear.
- If there is a problem with the vehicle, a warning may sound and a message may appear.

If the situation occurs, depress the brake pedal and release EPB by pressing the EPB switch.



### WARNING

- **Whenever leaving the vehicle or parking, always come to a complete stop and continue to depress the brake pedal.**

Shift the gear into P (Park), pull the EPB switch, and press the Engine Start/Stop button to the OFF position. Take the Key with you when leaving the vehicle.

Vehicles not fully engaged in P (Park) with the parking brake set are at risk for moving inadvertently and causing injury to yourself or others.

- **NEVER** allow anyone who is unfamiliar with the vehicle to touch the EPB switch. If EPB is released unintentionally, serious injury may occur.
- Only release EPB when you are seated inside the vehicle with your foot firmly on the brake pedal.

### NOTICE

- Do not apply the accelerator pedal while the parking brake is engaged. If you depress the accelerator pedal with EPB engaged, a warning will sound and a message will appear. Damage to the parking brake may occur.
- Driving with the parking brake on can overheat the braking system and cause premature wear or damage to brake parts. Make sure EPB is released and the Parking Brake warning light is off before driving.



### Information

- A clicking sound may be heard while operating or releasing the EPB. These conditions are normal and indicate that EPB is functioning properly.
- When leaving your keys with a parking attendant or assistant, make sure to inform him/her how to operate EPB.



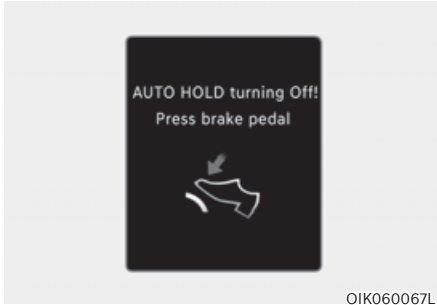

OIK060067L

### **AUTO HOLD turning Off! Press brake pedal**

When the conversion from Auto Hold to EPB is not working properly a warning will sound and a message will appear.

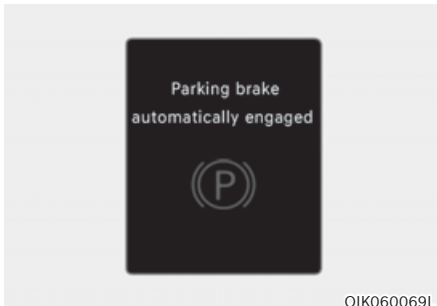

OIK060069L

### **Parking brake automatically engaged**

When EPB is applied while Auto Hold is activated, a warning will sound and a message will appear.

### **EPB malfunction**

Electronic Parking Brake (EPB) warning light illuminates if the Engine Start/Stop button is pressed to the ON position and goes off in approximately 3 seconds if the system is operating normally.

If the EPB warning light remains on, comes on while driving, or does not come on when the Engine Start/Stop button is pressed to the ON position, this indicates that the EPB may have malfunctioned.

If this occurs, have the system checked by an authorized retailer of Genesis Branded products.

The EPB warning light may illuminate when the ESC indicator comes on to indicate that ESC is not working properly, but it does not indicate a malfunction of EPB.

### **NOTICE**

- **If the EPB warning light is still on, have the system checked by an authorized retailer of Genesis Branded products.**
- **If the Parking Brake warning light does not illuminate or blinks even though the EPB switch was pulled up, EPB may not be applied.**
- **If the Parking Brake warning light blinks when the EPB warning light is on, press the switch, and then pull it up. Repeat this one more time. If the EPB warning does not go off, have the system checked by an authorized retailer of Genesis Branded products.**

### Parking brake warning light

**(P)** Check the Parking Brake warning light by pressing the Engine Stop/Start button to the ON position.

This light illuminate when the parking brake is applied with the Engine Stop/Start button in the START or ON position.

Before driving, be sure the parking brake is released and the Parking Brake warning light is OFF.

If the Parking Brake warning light remains on after the parking brake is released while the engine is running, there may be a malfunction in the brake system. Immediate attention is necessary.

If at all possible, cease driving the vehicle immediately. If that is not possible, use extreme caution while operating the vehicle and only continue to drive the vehicle until you can reach a safe location.

### When the EPB (Electronic Parking Brake) does not release

If the EPB does not release normally, contact an authorized retailer of Genesis Branded products by loading the vehicle on a flatbed tow truck and have the system checked.

### Auto Hold

Auto Hold helps maintain the vehicle in a standstill even though the brake pedal is not depressed after the driver brings the vehicle to a complete stop by depressing the brake pedal.

#### **i** Information

**The vehicle is maintained at the state (Auto Hold on or off) before the engine was turned off when the vehicle is restarted.**

#### **To apply:**

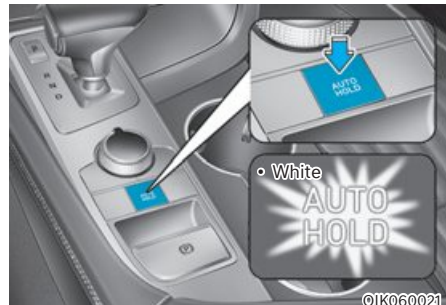

1. With the driver's door and engine hood closed, depress the brake pedal and then press the AUTO HOLD switch. The white AUTO HOLD indicator will come on and the system will be in the standby position.

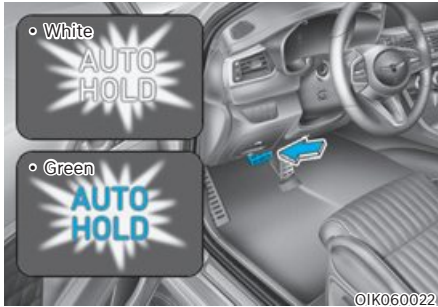

2. When you stop the vehicle completely by depressing the brake pedal, Auto Hold maintains the brake pressure to hold the vehicle stationary. The indicator changes from white to green.
3. The vehicle will remain stationary even if you release the brake pedal.
4. If EPB is applied, Auto Hold will be released.

#### To release:

- If you depress the accelerator pedal with the gear in D (Drive), R (Reverse) or Manual shift mode, the Auto Hold will be released automatically and the vehicle will start to move. The AUTO HOLD indicator changes from green to white.
- If the vehicle is restarted using the cruise control toggle switch (RES+ or SET-) while Auto Hold and cruise control is operating, Auto Hold will be released regardless of accelerator pedal operation. The AUTO HOLD indicator changes from green to white.

#### WARNING

When Auto Hold is automatically released by depressing the accelerator pedal, always take a look around your vehicle.

Slowly depress the accelerator pedal for a smooth start.

#### To cancel:

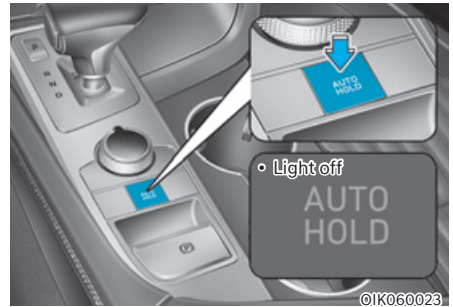

1. Depress and hold the brake pedal.
  2. Press the AUTO HOLD switch.
- The AUTO HOLD indicator will turn off.

#### WARNING

To prevent, unexpected and sudden vehicle movement, **ALWAYS** press your foot on the brake pedal to cancel Auto Hold before you:

- Drive downhill.
- Drive the vehicle in R (Reverse).
- Park the vehicle.

**i** Information

- The Auto Hold does not operate when:
  - The driver's door is opened
  - The engine hood is opened
  - The gear is in P (Park)
  - EPB is applied
- For your safety, the Auto Hold automatically switches to EPB when:
  - The driver's door is opened
  - The engine hood is opened
  - The vehicle is in a standstill for more than 10 minutes
  - The vehicle is standing on a steep slope
  - The vehicle moved several times

In these cases, the Parking Brake warning light comes on, the AUTO HOLD indicator changes from green to white, and a warning sound and a message will appear to inform you that EPB has been automatically engaged. Before driving off again, depress the brake pedal, check the surrounding area near your vehicle and release the parking brake manually with the EPB switch.

- While operating Auto Hold, you may hear mechanical noise. However, it is normal operating noise.

**NOTICE**

If the AUTO HOLD indicator changes to yellow, Auto Hold is not working properly. Contact an authorized retailer of Genesis Branded products.

**⚠** WARNING

- Depress the accelerator pedal slowly when you start the vehicle.
- For your safety, cancel Auto Hold when you drive downhill, back up the vehicle or park the vehicle.

**NOTICE**

If there is a malfunction with the driver's door or engine hood open detection system, Auto Hold may not work properly.

Contact an authorized retailer of Genesis Branded products.

## Warning messages

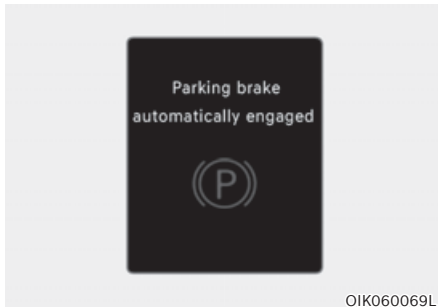

### Parking brake automatically engaged

When EPB is applied while Auto Hold is activated, a warning will sound and a message will appear.

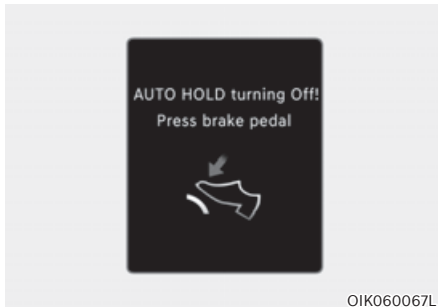

### AUTO HOLD turning Off! Press brake pedal

When the conversion from Auto Hold to EPB is not working properly a warning will sound and a message will appear.

When this message is displayed, Auto Hold and EPB may not operate. For your safety, depress the brake pedal.



### Press brake pedal to deactivate AUTO HOLD

If you did not apply the brake pedal when you release Auto Hold by pressing the AUTO HOLD switch, a warning will sound and a message will appear.



### AUTO HOLD conditions not met. Close door and hood.

When you press the AUTO HOLD switch, if the driver's door and engine hood are not closed, a warning will sound and a message will appear on the cluster LCD display.

Press the AUTO HOLD switch after closing the driver's door and hood.

## Anti-Lock Brake System (ABS)



### WARNING

**Anti-Lock Braking System (ABS) or Electronic Stability Control (ESC) system will not prevent accidents due to improper or dangerous driving maneuvers. Even though vehicle control is improved during emergency braking, always maintain a safe distance between you and objects ahead of you. Vehicle speeds should always be reduced during extreme road conditions. The braking distance for vehicles equipped with ABS or ESC may be longer than for those without these systems in the following road conditions.**

**Drive your vehicle at reduced speeds during the following conditions:**

- **Rough, gravel or snow-covered roads.**
- **On roads where the road surface is pitted or has different surface height.**
- **Tire chains are installed on your vehicle.**

**The safety features of ABS or ESC equipped vehicle should not be tested by high speed driving or cornering. This could endanger the safety of yourself or others.**

ABS is an electronic braking system that helps prevent a braking skid. ABS allows the driver to steer and brake at the same time.

## Using ABS

To obtain the maximum benefit from your ABS in an emergency situation, do not attempt to modulate your brake pressure and do not try to pump your brakes. Depress your brake pedal as hard as possible.

When you apply your brakes under conditions which may lock the wheels, you may hear sounds from the brakes, or feel a corresponding sensation in the brake pedal. This is normal and it means your ABS is active.

ABS does not reduce the time or distance it takes to stop the vehicle.

Always maintain a safe distance from the vehicle in front of you.

ABS will not prevent a skid that results from sudden changes in direction, such as trying to take a corner too fast or making a sudden lane change. Always drive at a safe speed for the road and weather conditions.

ABS cannot prevent a loss of stability. Always steer moderately when braking hard. Severe or sharp steering wheel movement can still cause your vehicle to veer into oncoming traffic or off the road.

On loose or uneven road surfaces, operation of the anti-lock brake system may result in a longer stopping distance than for vehicles equipped with a conventional brake system.

The ABS ((ABS)) warning light will stay on for several seconds after the Engine Start/Stop button is in the ON position.

During that time, ABS will go through self-diagnosis and the light will go off if everything is normal. If the light stays on, you may have a problem with your ABS. Contact an authorized retailer of Genesis Branded products as soon as possible.

## WARNING

If the ABS ((ABS)) warning light is on and stays on, you may have a problem with the ABS. Your power brakes will work normally. To reduce the risk of serious injury or death, contact your authorized retailer of Genesis Branded products as soon as possible.

## NOTICE

When you drive on a road having poor traction, such as an icy road, and apply your brakes continuously, ABS will be active continuously and the ABS ((ABS)) warning light may illuminate. Pull your vehicle over to a safe place and turn the vehicle off.

Restart the vehicle. If the ABS warning light is off, then your ABS system is normal.

Otherwise, you may have a problem with your ABS system. Contact an authorized retailer of Genesis Branded products as soon as possible.

## Information

When you jump start your vehicle because of a drained battery, the ABS ((ABS)) warning light may turn on at the same time. This happens because of the low battery voltage. It does not mean your ABS is malfunctioning. Have the battery recharged before driving the vehicle.

## Electronic Stability Control (ESC) (if equipped)

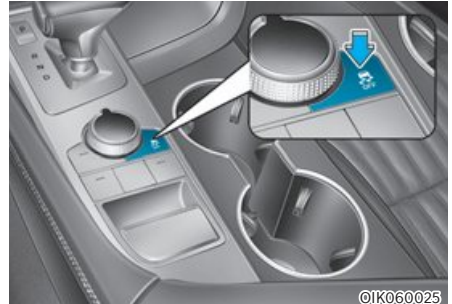

Electronic Stability Control helps to stabilize the vehicle during cornering maneuvers.

ESC checks where you are steering and where the vehicle is actually going. ESC applies braking pressure to any one of the vehicle's brakes and intervenes in the engine management system to assist the driver with keeping the vehicle on the intended path. It is not a substitute for safe driving practices. Always adjust your speed and driving to the road conditions.

## WARNING

Never drive too fast for the road conditions when cornering. ESC will not prevent accidents.

Excessive speed in turns, abrupt maneuvers, and hydroplaning on wet surfaces can result in severe accidents.

## ESC operation

### ESC ON condition

When the Engine Start/Stop button is in the ON position, ESC and the ESC OFF indicator lights illuminate for approximately three seconds. After both lights go off, ESC is enabled.

### When operating



When ESC is in operation, the ESC indicator light blinks:

- When you apply your brakes under conditions which may lock the wheels, you may hear sounds from the brakes, or feel a corresponding sensation in the brake pedal. This is normal and it means your ESC is active.
- When ESC activates, the engine may not respond to the accelerator as it does under routine conditions.
- If Cruise Control was in use when ESC activates, Cruise Control automatically disengages. Cruise Control can be reengaged when the road conditions allow. **See “Cruise Control System” section in chapter 7 (if equipped).**
- When moving out of the mud or driving on a slippery road, the engine RPM (revolutions per minute) may not increase even if you press the accelerator pedal deeply. This is to maintain the stability and traction of the vehicle and does not indicate a problem.

### ESC OFF condition



To cancel ESC operation:

- State 1

Press the ESC OFF button briefly. The ESC OFF indicator light and/or message 'Traction Control disabled' will illuminate. In this state, the traction control function of ESC (engine management) is disabled, but the brake control function of ESC (braking management) still operates.

ESC OFF state 1 will be automatically set and the ESC OFF indicator light and/or message will illuminate on the cluster when SPORT+ mode is selected for Drive mode.

- State 2

Press and hold the ESC OFF button continuously for more than 3 seconds. The ESC OFF indicator light and/or message 'Traction & Stability Control disabled' illuminates and a warning chime sounds. In this state, both the traction control function of ESC (engine management) and the brake control function of ESC (braking management) are disabled.

If the Engine Start/Stop button is pressed to the OFF position when ESC is off, ESC remains off. Upon restarting the vehicle, ESC will automatically turn on again.



## Indicator lights

- ESC indicator light (blinks)



- ESC OFF indicator light (comes on)



When the Engine Start/Stop button is pressed to the ON position, the ESC indicator light illuminates, then goes off if the ESC system is operating normally.

The ESC indicator light blinks whenever ESC is operating.

If the ESC indicator light stays on, your vehicle may have a malfunction with the ESC system. When this warning light illuminates, have the vehicle checked by an authorized retailer of Genesis Branded products as soon as possible.

The ESC OFF indicator light comes on when ESC is turned off.



### WARNING

When ESC is blinking, this indicates ESC is active:

Drive slowly and **NEVER** attempt to accelerate. **NEVER** turn ESC off while the ESC indicator light is blinking or you may lose control of the vehicle resulting in an accident.

### NOTICE

Driving with wheels and tires with different sizes may cause the ESC system to malfunction. Before replacing tires, make sure all four tires and wheels are the same size. Never drive the vehicle with different sized wheels and tires installed.

## ESC OFF usage

### When Driving

The ESC OFF mode should only be used briefly to help free the vehicle if stuck in snow or mud, by temporarily stopping operation of ESC, to maintain wheel torque.

To turn ESC off while driving, press the ESC OFF button while driving on a flat road surface.

### NOTICE

To prevent damage to the transmission:

- **Do not allow wheel(s) of one axle to spin excessively while the ESC, ABS, and Parking Brake warning lights are displayed. The repairs would not be covered by the vehicle warranty. Reduce engine power and do not spin the wheel(s) excessively while these lights are displayed.**
- **When operating the vehicle on a dynamometer, make sure ESC is turned off (ESC OFF light illuminated).**



### Information

Turning ESC off does not affect ABS or standard brake system operation.

## Vehicle Stability Management (VSM)

Vehicle Stability Management is a function of the Electronic Stability Control (ESC) system. It helps the vehicle stay stable when accelerating or braking suddenly on wet, slippery and rough roads where traction over the four tires can suddenly become uneven.



### WARNING

Take the following precautions when using Vehicle Stability Management:

- **ALWAYS** check the speed and the distance to the vehicle ahead. **VSM is not a substitute for safe driving practices.**
- **Never drive too fast for the road conditions. VSM will not prevent accidents. Excessive speed in bad weather, on slippery and uneven roads can result in severe accidents.**

### VSM operation

#### When operating

When you apply your brakes under conditions which may activate ESC, you may hear sounds from the brakes, or feel a corresponding sensation in the brake pedal. This is normal and it means your VSM is active.



### Information

VSM does not operate when:

- **Driving on a banked road such as gradient or incline.**
- **Driving in reverse.**
- **The ESC OFF indicator light is on.**
- **The EPS (Electric power steering) warning light (⚠) is on or blinks.**

### VSM OFF condition

To cancel VSM operation, press the ESC OFF button. ESC OFF (OFF) indicator light will illuminate.

To turn on VSM, press the ESC OFF button again. The ESC OFF indicator light will go out.



### WARNING

If the ESC (⚠) indicator light or EPS (⚠) warning light stays illuminated or blinks, your vehicle may have a malfunction with the VSM system. When the warning light illuminates, have the vehicle checked by an authorized retailer of Genesis Branded products as soon as possible.

### NOTICE

Driving with wheels and tires with different sizes may cause the VSM system to malfunction. Before replacing tires, make sure all four tires and wheels are the same size. Never drive the vehicle with different sized tires and wheels installed.

## Hill-Start Assist Control (HAC)

Hill-Start Assist Control helps prevent the vehicle from rolling backwards when starting a vehicle from a stop on a hill. The system operates the brakes automatically for approximately 5 seconds and releases the brake after 5 seconds or when the accelerator pedal is depressed.



### WARNING

**Always be ready to depress the accelerator pedal when starting off an incline. Hill-Start Assist Control activates only for approximately 5 seconds.**



### Information

- **Hill-Start Assist Control does not operate when the gear is shifted to P (Park) or N (Neutral).**
- **Hill-Start Assist Control activates even when the ESC (Electronic Stability Control) is off. However, it does not activate, when ESC does not operate normally.**

## Good Braking Practices



### WARNING

**Whenever leaving the vehicle or parking, always come to a complete stop and continue to depress the brake pedal. Shift the vehicle to P (Park), apply the parking brake, and press the Engine Start/Stop button to the OFF position.**

**Vehicles parked with the parking brake not applied or not fully engaged may roll inadvertently and may cause injury to the driver and others. ALWAYS apply the parking brake before exiting the vehicle.**

Wet brakes can be dangerous! The brakes may get wet if the vehicle is driven through standing water or if it is washed. Your vehicle will not stop as quickly if the brakes are wet. Wet brakes may cause the vehicle to pull to one side.

To dry the brakes, apply the brakes lightly until the braking action returns to normal. If the braking action does not return to normal, stop as soon as it is safe to do so and we recommend that you call an authorized retailer of Genesis Branded products for assistance.

DO NOT drive with your foot resting on the brake pedal. Even light, but constant pedal pressure can result in the brakes overheating, brake wear, and possibly even brake failure.

If a tire goes flat while you are driving, apply the brakes gently and keep the vehicle pointed straight ahead while you slow down. When you are moving slowly enough for it to be safe to do so, pull off the road and stop in a safe location.



Keep your foot firmly on the brake pedal when the vehicle is stopped to prevent the vehicle from rolling forward.

## ALL WHEEL DRIVE (AWD) (IF EQUIPPED)

All Wheel Drive (AWD) delivers engine power to front and rear wheels for maximum traction. AWD is useful when extra traction is required, such as when driving on, muddy, wet, or snow-covered roads.



### WARNING

If the AWD warning light () stays on the instrument cluster, your vehicle may have a malfunction with the AWD system. When the AWD warning light () illuminates we recommend that the vehicle be checked by an authorized retailer of Genesis Branded products as soon as possible.



### WARNING

To reduce the risk of **SERIOUS INJURY** or **DEATH**:

- Do not drive in conditions that exceed the vehicles intended design such as challenging off-road conditions.
- Avoid high speeds when cornering or turning.
- Do not make quick steering wheel movements, such as sharp lane changes or fast, sharp turns.
- The risk of a rollover is greatly increased if you lose control of your vehicle at highway speeds.
- Loss of control often occurs if two or more wheels drop off the roadway and the driver over steers to reenter the roadway.
- In the event your vehicle leaves the roadway, do not steer sharply. Instead, slow down before pulling back into the travel lanes.

### NOTICE

- Do not drive in water if the level is higher than the bottom of the vehicle.
- Check your brake condition once you are out of mud or water. Depress the brake pedal several times as you move slowly until you feel normal braking return.
- Shorten your scheduled maintenance interval if you drive in off-road conditions such as sand, mud or water (see "Maintenance Under Severe Usage Conditions" section in chapter 9).
- Always wash your vehicle thoroughly after off road use, especially the bottom of the vehicle.
- Be sure to equip the vehicle with four tires of the same size and type.
- Make sure that a full time AWD vehicle is towed by a flat bed tow truck.

## For Safe AWD Operation

### **Before driving**

- Make sure all passengers are wearing seat belts.
- Sit upright and closer to the steering wheel than usual. Adjust the steering wheel to a position comfortable for you to drive.

### **Driving on snow-covered or icy roads**

- Start off slowly by applying the accelerator pedal gently.
- Use snow tires or tire chains.
- Keep sufficient distance between your vehicle and the vehicle in front of you.
- Apply engine braking during deceleration by using the paddle shifter (manual shift mode) and manually selecting a lower gear.
- Avoid speeding, rapid acceleration, sudden brake applications, and sharp turns to prevent skids.

### **Driving in sand or mud**

- Maintain slow and constant speed.
- Use tire chains driving in mud if necessary.
- Keep sufficient distance between your vehicle and the vehicle in front of you.
- Reduce vehicle speed and always check the road condition.
- Avoid speeding, rapid acceleration, sudden brake applications, and sharp turns to prevent getting stuck.

### **NOTICE**

When the vehicle is stuck in snow, sand or mud, place a nonslip material under the drive wheels to provide traction **OR** slowly spin the wheels in forward and reverse directions which causes a rocking motion that may free the vehicle.

However, avoid running the engine continuously at high RPM, doing so may damage the AWD system.

### **i** Information

- When using Snow Tires, mount them on all four wheels.
- When using tire chains, install them on the rear tires. However, driving speed must be below 20 mph (30km/h) and minimize the driving distance. High-speed or long-term driving with tire chains installed may malfunction or damage the AWD system.

If tire chains must be used, use AutoSock (fabric snow chain) and install the tire chain after reviewing the instructions provided with the tire chains.

For more information on Snow Tires and Tire Chains, refer to "Winter Driving" in this chapter.

### **Driving up or down hills**

- Driving uphill
  - Before starting off, check if it is possible to drive uphill.
  - Drive as straight as possible.
- Driving downhill
  - Do not change gear while driving downhill. Select gear before driving downhill.
  - Drive slowly using engine braking while driving downhill.
  - Drive straight as possible.



#### **WARNING**

**Exercise extreme caution driving up or down steep hills. The vehicle may flip over depending on the grade, terrain, water and mud conditions.**



#### **WARNING**

**Do not drive across the contour of steep hills. A slight change in the wheel angle can destabilize the vehicle, or a stable vehicle may lose stability if the vehicle stops its forward motion. Your vehicle may roll over and lead to a serious injury or death.**

### **Emergency Precautions**

#### **Tires**

When replacing tires, be sure to equip all four tires with the same size, type, tread pattern, brand and load-carrying capacity.



#### **WARNING**

**Do not use tire and wheel with different size and type from the one originally installed on your vehicle. It can affect the safety and performance of your vehicle, which could lead to steering failure or rollover causing serious injury.**

In an emergency situation, a compact spare tire may be used. But, do not use the compact spare tire continuously. Repair or replace the original tire as soon as possible to avoid failure of the differential or AWD system.

## WARNING



Never start or run the engine while a vehicle is raised on a jack. The vehicle can slip or roll off of a jack causing serious injury or death to you or those nearby.

### **Towing**

AWD vehicles must be towed with a wheel lift and dollies or flatbed equipment with all the wheels off the ground. **For more details, refer to "Towing" section in chapter 8.**

### **Vehicle inspection**

- If the vehicle needs to be operated on a vehicle lift do not attempt to stop any of the four wheels from turning. This could damage the AWD system.
- Never engage the parking brake while running the engine on a car lift. This may damage the AWD system.

### **Dynamometer testing**

An AWD vehicle must be tested on a special four wheel chassis dynamometer.

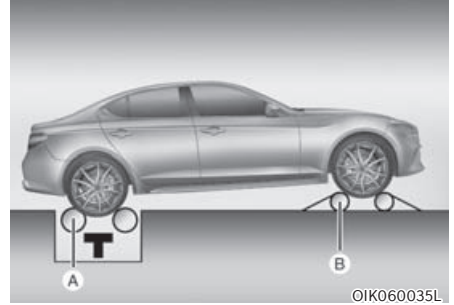

[A] : Roll tester (Speedometer),  
[B] : Temporary free roller

An AWD vehicle should not be tested on a 2WD roll tester. If a 2WD roll tester must be used, perform the following procedure:

1. Check the tire pressures recommended for your vehicle.
2. Place the rear wheels on the roll tester for a speedometer test as shown in the illustration.
3. Release the parking brake.
4. Place the front wheels on the temporary free roller as shown in the illustration.

## WARNING

**Keep away from the front of the vehicle while the vehicle is in gear on the dynamometer. The vehicle can jump forward and cause serious injury or death.**

## LIMITED SLIP DIFFERENTIAL (IF EQUIPPED)

Limited Slip Differential refers to a feature equipped with a mechanism that controls the differential functions of the wheels in the rear differential.

The Limited Slip Differential helps improve handling performance when circling at high speed.

### **WARNING**

**Never run wheels with one of them lifted by the jack. It is extremely dangerous for a vehicle equipped with Limited Slip Differential.**

### **Information**

**Be sure to inject oil for exclusive use of LSD when replacing Rear Differential (for LSD) Oil. Refer to “Recommended lubricants and capacities” in chapter 2.**

## ELECTRONIC CONTROL SUSPENSION (IF EQUIPPED)

Electronic Control Suspension controls the vehicle suspension automatically using vehicle sensors to maximize driving comfort by taking into account the driving conditions such as speed, surface of the road, cornering, stopping requirements and acceleration.

### System Malfunction

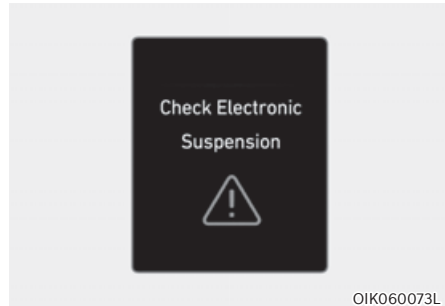

#### Check Electronic Suspension

When Electronic Control Suspension is not working properly, this warning message will appear on the cluster LCD display. If this occurs, have the system inspected by an authorized retailer of Genesis Branded products.



## LAUNCH CONTROL (IF EQUIPPED)

Launch Control system controls the vehicle to help reduce wheel spin or slip on a hard acceleration from a standing start.

### Prerequisite for Activation

Launch Control gets ready to be activated, when the following prerequisites are satisfied.

- The engine is warmed up.
- Malfunction warning lights related to the engine and ESC (Electronic Stability Control) are off.



### CAUTION

**For safety purposes, check the following conditions before using Launch control.**

- **The driver's seat belt is fastened.**
- **All doors, hood and trunk are closed.**
- **The vehicle is at a complete stop.**
- **Align the steering wheel straight.**

### Launch Control Activation

To activate Launch Control:

1. Select SPORT or SPORT+ mode using the drive mode selection knob (or button). SPORT or SPORT+ indicator will illuminate on the instrument cluster LCD display.
2. Turn off ESC by pressing the ESC OFF button for more than 3 seconds. The ESC OFF indicator will illuminate on the instrument cluster.
3. Shift to the D (Drive) position.

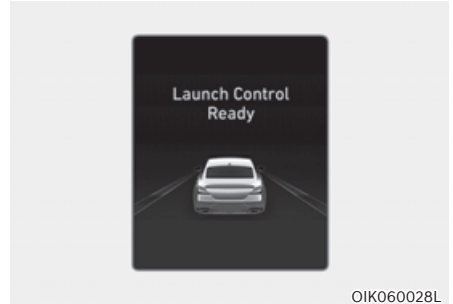

4. Depress the brake pedal firmly with your left foot, while depressing the accelerator pedal down fully with your right foot. Then, the Engine RPM will reach an optimized level.

The message 'Launch Control Ready' will appear on the instrument cluster LCD display.

5. A smooth, quick release of the brake pedal, while maintaining full depression of the accelerator pedal will initiate launching of the vehicle.

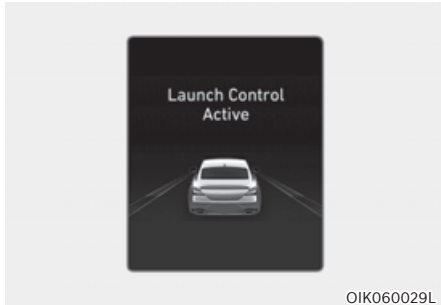

OIK060029L

6. During vehicle launching, continue to depress the accelerator pedal to keep the Launch Control system active until desired duration.

The message 'Launch Control Active' will appear on the cluster LCD display.

To deactivate (end) Launch Control, release the accelerator pedal.

### **i** Information

**Launch Control is available again after cooling down by driving the vehicle for at least 3 minutes.**

### **⚠** CAUTION

- Launch Control system is intended for use at a closed race track and not intended for use on public roads. It will not compensate for driver's who are inexperienced or lack familiarity with the race track.
- Do not use Launch Control during break-in period of the vehicle.

### **NOTICE**

Constant use of Launch Control can put enormous stress on the vehicle resulting in premature wear of related components.

## Limited Use of Launch Control



OIK057181N

### **Transmission temperature too high. Launch control not available**

A warning message will pop up on the cluster LCD display if the transmission fluid temperature is above a certain level while using Launch Control. Also, Launch Control will be automatically deactivated.

If this occurs, the driver should cool down the transmission fluid temperature by driving the vehicle at a constant speed over 37 mph (60 km/h).

## COASTING (IF EQUIPPED)

When certain conditions are met, the engine is automatically decoupled from the transmission while gear remains in D (Drive). When Coasting is operating, the engine stays at idling speed to help reduce fuel consumption and increase coasting distance.

### Coasting Setting

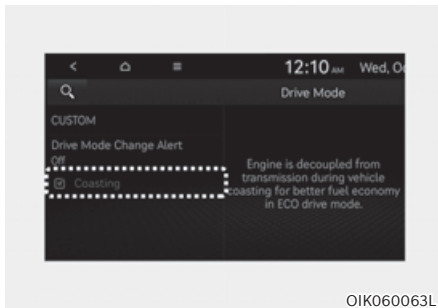

OIK060063L

- The Coasting function must be turned ON from the Settings menu in the infotainment system screen. Select:
  - Setup → Vehicle Settings → Drive Mode → Coasting

**See additional information in supplied Infotainment Manual.**

- When Coasting is turned ON and the conditions are met, the function operates with a 'Coasting' message illuminated on the instrument cluster.

### Coasting Operating Conditions

The Coasting function will operate when the accelerator pedal is depressed and released under the following conditions.

- ECO is selected for driving mode
- ECO is selected for Powertrain in the CUSTOM menu from the infotainment system screen. If Smart is selected, driver acceleration should be mild
- The gear is in D (Drive)
- Smart Cruise Control button is OFF
- Smart Cruise Control function is in standby
- The accelerator or brake pedal is not depressed
- The vehicle's speed is within 30~100 mph (50~160 km/h) range
- The road gradient is within -5~+5% range

### **i** Information

- **If the front radar for Smart Cruise Control cannot operate normally, the inter-vehicle distance and relative speed condition are automatically ignored.**
- **The Coasting function works after the engine is turned on, the transmission is warmed up, and the engine sensor self-diagnosis is completed.**
- **Depending on the driving situation, Coasting operation may be temporarily delayed even if the above conditions are met.**

### Coasting Release Conditions

The Coasting function will be automatically released when the following conditions are met.

- COMFORT, SPORT, SPORT+ is selected for driving mode
- The driver uses the paddle shifter
- Smart Cruise Control is activated (Set speed appears on the cluster)
- The vehicle's speed exceeds 30~100 mph (50~160 km/h) range
- The road gradient is under -5% or over +5%

#### Information

**It is recommended to turn off the Coasting function if you are driving under frequently stop-and-go condition. Change the drive mode to COMFORT, SPORT, SPORT+ or deselect Coasting from the infotainment system screen.**

#### **NOTICE**

- **If the accelerator pedal is pressed quickly for accelerating with the Coasting function in operation, acceleration may occur after the engagement of the clutch inside the transmission. In turn, the driver may continue to feel acceleration even after the system is turned off.**
- **Driving with the Coasting function off may be required in some cases since the engine brake is not applied while the Coasting function is operating.**
- **Operating the infotainment system screen to activate or deactivate the Coasting function while driving may be dangerous as the driver's attention is dispersed.**

## DRIVE MODE INTEGRATED CONTROL SYSTEM (IF EQUIPPED)

Drive mode may be selected according to the driver's preference or road condition.

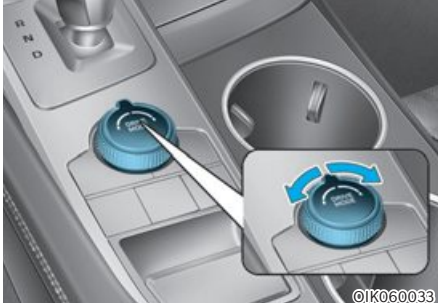

### Drive mode

The mode changes whenever the DRIVE MODE selection knob is rotated.

### **COMFORT mode**

COMFORT mode provides smooth driving and comfortable riding.

### **ECO mode**



ECO mode helps improve fuel efficiency for eco-friendly driving.

Fuel efficiency varies according to the driver's driving habit and road condition.

- When ECO mode is selected, the ECO indicator will illuminate on the instrument cluster.
- When ECO mode is activated:
  - The acceleration response may be slightly reduced if the accelerator pedal is depressed moderately.
  - The air conditioner performance may be limited.
  - The shift pattern of the automatic transmission may change.
  - Engine noise may be louder at some automatic transmission shifts as down-shift requires pressing down more on the accelerator.

The above situations are normal conditions when the ECO mode is activated to help improve fuel efficiency.

### **Limitations of ECO mode**

If the following conditions occur while ECO mode is operating, the system operation is limited even though there is no change in ECO indicator.

- When coolant temperature is low:  
The system will be limited until engine performance becomes normal.
- When driving up a hill:  
The system will be limited to gain power when driving uphill because engine torque is restricted.
- When driving the vehicle in manual shift mode using the paddle shifter.  
The system will be limited according to the shift location.

### **SPORT mode**

**SPORT** SPORT mode provides sporty but firm riding.

In the SPORT mode, the fuel efficiency may decrease.

- When SPORT mode is selected, SPORT indicator will illuminate on the instrument cluster.
- Whenever the engine is restarted, the drive mode will revert back to the COMFORT mode. If SPORT mode is desired, re-select SPORT mode.
- When SPORT mode is activated:
  - The engine RPM will tend to remain raised over a certain length of time even after releasing the accelerator
  - Upshifts are delayed when accelerating

### **i Information**

**SPORT Mode firm ride applies to vehicle equipped with ESC.**

### **CUSTOM mode (if equipped)**

**CUSTOM** In CUSTOM mode, the driver can select separate modes for each items in the infotainment system screen.

- Powertrain: ECO/COMFORT/SPORT/SPORT+
- Steering wheel: COMFORT/SPORT/SPORT+
- Suspension: COMFORT/SPORT/SPORT+
- AWD system: ECO/COMFORT/SPORT

### **See additional information in supplied Infotainment Manual.**

- When the CUSTOM mode is selected, CUSTOM indicator will illuminate on the instrument cluster.
- Whenever the engine is restarted, the drive mode will revert back to COMFORT mode. If CUSTOM mode is desired, re-select CUSTOM mode.

### **SPORT+ mode**

**SPORT+** SPORT+ mode provides sporty but firm riding.

In SPORT+ mode, the fuel efficiency may decrease.

- When SPORT+ mode is selected, SPORT+ indicator will illuminate on the instrument cluster.
- Whenever the engine is restarted, the drive mode will revert back to COMFORT mode. If SPORT+ mode is desired, re-select SPORT+ mode.
- When SPORT+ mode is activated:
  - The engine RPM will tend to remain raised over a certain length of time even after releasing the accelerator
  - Upshifts are delayed when accelerating
  - Downshifts are advanced while braking.

### **NOTICE**

**In SPORT or SPORT+ mode, the fuel efficiency may decrease.**

### **i Information**

**SPORT+ Mode firm ride applies to vehicle equipped with ESC.**

## Vehicle Characteristic

The characteristic of each components varies according to which drive mode is selected.

	Component	DRIVE MODE		
		COMFORT Mode	SPORT Mode	SPORT+ Mode
Engine & Driving	Power train	COMFORT	SPORT	SPORT+
	Launch Control	Off	On	On
Chassis	Steering	COMFORT	SPORT	SPORT+
	ESC*1	COMFORT	SPORT	SPORT(or SPORT+) (TCS*2 OFF)
Sound	ASD*3	COMFORT	SPORT	SPORT

**The information provided may differ depending on which features are applicable to your vehicle.**

When driving in the CUSTOM mode, Launch Control/Active Sound Design System may vary depending on the CUSTOM mode-Powertrain system settings.

\*1: Electronic Stability Control

\*2: Traction Control System

\*3: Active Sound Design

## SPECIAL DRIVING CONDITIONS

### Hazardous Driving Conditions

When hazardous driving elements are encountered such as water, snow, ice, mud and sand, take the following precautions:

- Drive cautiously and maintain a longer braking distance.
- Avoid abrupt braking or steering.
- When your vehicle is stuck in snow, mud, or sand, use the second gear. Accelerate slowly to avoid unnecessary wheel spin.
- Put sand, rock salt, tire chains or other non-slip materials under the wheels to provide additional traction while the vehicle becomes stuck in ice, snow, or mud.



#### WARNING

**Using the paddle shifters to downshift to a lower gear while driving on slippery surfaces can cause an accident. The sudden change in tire speed could cause the tires to skid. Be careful when downshifting on slippery surfaces.**

### Rocking the Vehicle

If it is necessary to rock the vehicle to free it from snow, sand, or mud, first turn the steering wheel right and left to clear the area around your front wheels. Then, shift back and forth between R (Reverse) and a forward gear.

Try to avoid spinning the wheels, and do not race the engine.

To prevent transmission wear, wait until the wheels stop spinning before shifting gears. Release the accelerator pedal while shifting, and press lightly on the accelerator pedal while the transmission is in gear. Slowly spinning the wheels in forward and reverse directions causes a rocking motion that may free the vehicle.



#### WARNING

**If the vehicle is stuck and excessive wheel spin occurs, the temperature in the tires can increase very quickly. If the tires become damaged, a tire blow out or tire explosion can occur. This condition is dangerous - you and others may be injured. Do not attempt this procedure if people or objects are anywhere near the vehicle.**

**If you attempt to free the vehicle, the vehicle can overheat quickly, possibly causing an engine compartment fire or other damage. Try to avoid spinning the wheels as much as possible to prevent overheating of either the tires or the engine. DO NOT allow the vehicle to spin the wheels above 35 mph (56 km/h).**



## **i** Information

The ESC system must be turned OFF before rocking the vehicle.

### **NOTICE**

**If you are still stuck after rocking the vehicle a few times, have the vehicle pulled out by a tow vehicle to avoid engine overheating, possible damage to the transmission, and tire damage. See “Towing” section in chapter 8.**

## Smooth Cornering

Avoid braking or gear changing in corners, especially when roads are wet. Ideally, corners should always be taken under gentle acceleration.

## Driving at Night

Night driving presents more hazards than driving in the daylight. Here are some important tips to remember:

- Slow down and keep more distance between you and other vehicles, as it may be more difficult to see at night, especially in areas where there may not be any street lights.
- Adjust your mirrors to reduce the glare from other drivers' headlamps.
- Keep your headlamps clean and properly aimed. Dirty or improperly aimed headlamps will make it much more difficult to see at night.
- Avoid staring directly at the headlamps of oncoming vehicles. You could be temporarily blinded, and it will take several seconds for your eyes to readjust to the darkness.

## Driving in the Rain

Rain and wet roads can make driving dangerous. Here are a few things to consider when driving in the rain or on slick pavement:

- Slow down and allow extra following distance. A heavy rainfall makes it harder to see and increases the distance needed to stop your vehicle.
- Turn OFF your Cruise Control. (if equipped)
- Replace your windshield wiper blades when they show signs of streaking or missing areas on the windshield.
- Be sure your tires have enough tread. If your tires do not have enough depth of tire tread, making a quick stop on wet pavement can cause a skid and possibly lead to an accident. **See “Tire Tread” section in chapter 9.**
- Turn on your headlamps to make it easier for others to see you.
- Driving too fast through large puddles can affect your brakes. If you must go through puddles, try to drive through them slowly.
- If you believe your brakes may be wet, apply them lightly while driving until normal braking operation returns.

## Hydroplaning

If the road is wet enough and you are going fast enough, your vehicle may have little or no contact with the road surface and actually ride on the water. The best advice is SLOW DOWN when the road is wet.

**The risk of hydroplaning increases as the depth of tire tread decreases, refer to “Tire Tread” section in chapter 9.**

### Driving in Flooded Areas

Avoid driving through flooded areas unless you are sure the water is no higher than the bottom of the wheel hub. Drive through any water slowly. Allow adequate stopping distance because brake performance may be reduced.

After driving through water, dry the brakes by gently applying them several times while the vehicle is moving slowly.

### Highway Driving

#### **Tires**

Adjust the tire inflation, as specified. Under-inflation may overheat or damage the tires.

Do not install worn-out or damaged tires, which may reduce traction or fail the braking operation.



#### **Information**

**Never over-inflate your tires above the maximum inflation pressure, as specified on your tires.**

#### ***Fuel, engine coolant and engine oil***

Driving at higher speeds on the highway consumes more fuel and is less efficient than driving at a slower, more moderate speed. Maintain a moderate speed in order to conserve fuel when driving on the highway.

Be sure to check both the engine coolant level and the engine oil before driving.

#### ***Drive belt***

A loose or damaged drive belt may overheat the engine.

## WINTER DRIVING

The severe weather conditions of winter quickly wear out tires and cause other problems. To minimize winter driving problems, you should take the following suggestions:

### Snow or Icy Conditions

You need to keep sufficient distance between your vehicle and the vehicle in front of you.

Apply the brakes gently. Speeding, rapid acceleration, sudden brake applications, and sharp turns are potentially very hazardous practices. During deceleration, use engine braking to the fullest extent. Sudden brake applications on snowy or icy roads may cause the vehicle to skid.

To drive your vehicle in deep snow, it may be necessary to use snow tires or to install tire chains on your tires.

Always carry emergency equipment. Some of the items you may want to carry include tire chains, tow straps or chains, a flashlight, emergency flares, sand, a shovel, jumper cables, a window scraper, gloves, ground cloth, coveralls, a blanket, etc.

### Snow tires



#### WARNING

**Snow tires should be equivalent in size and type to the vehicle's standard tires. Otherwise, the safety and handling of your vehicle may be adversely affected.**

We recommend that you use snow tires when road temperature is below 45°F (7°C). Refer to the below chart, and mount the recommended snow tire for your vehicle.

Standard tire				Recommended snow tire			
Front		Rear		Front		Rear	
Tire size	Wheel size	Tire size	Wheel size	Tire size	Wheel size	Tire size	Wheel size
225/45R18	8.0Jx18	225/45R18	8.0Jx18	225/45R18	8.0Jx18	225/45R18	8.0Jx18
				225/40R19	8.0Jx19	255/35R19	8.5Jx19
225/40R19	8.0Jx19	255/35R19	8.5Jx19	225/45R18	8.0Jx18	225/45R18	8.0Jx18
				225/40R19	8.0Jx19	255/35R19	8.5Jx19

If you mount snow tires on your vehicle, make sure to use the same Inflation pressure as the original tires. Mount snow tires on all four wheels to balance your vehicle's handling in all weather conditions. The traction provided by snow tires on dry roads may not be as high as your vehicle's original equipment tires. Check with the tire dealer for maximum speed recommendations.

### Summer tires

- Summer tires are used to maximize the driving performance on dry roads.
- If the temperature is below 44°F (7°C) or you are driving on snowy or icy roads, the summer tires lose their brake performance and traction as the tire grip weakens significantly.
- If the temperature is below 44°F (7°C) or you are driving on snowy or icy roads, mount snow tires or all-season tires of the same size with your vehicle's standard tire for safe driving. Both snow and all-season tires have M+S markings.
- When using the M+S tires, use tires with the same tread produced by the same manufacturer for safe driving.
- When driving with the M+S tires with the lower maximum allowable speed than that of the vehicle's standard summer tire, be careful not to exceed the speed allowed for the M+S tires.

### Tire chains



Since the sidewalls on some radial tires are thinner than other types of tires, they may be damaged by mounting certain types of tire chains on them. Do not mount tire chains on vehicles equipped with aluminum wheels; if unavoidable use AutoSock® (fabric snow chain or similar). Install AutoSock® after reviewing the instructions provided with AutoSock®. Damage to your vehicle caused by improper use of fabric snow chains are not covered by your vehicle manufacturer's warranty.

### Information

**AutoSock® is a Registered trademark of AutoSock.**



## WARNING

The use of AutoSock® (fabric snow chain) may adversely affect vehicle handling:

- Drive less than 20 mph (30 km/h) or the AutoSock® manufacturer's recommended speed limit, whichever is lower.
- Drive carefully and avoid bumps, holes, sharp turns, and other road hazards, which may cause the vehicle to bounce.
- Avoid sharp turns or locked wheel braking.



## Information

- Install AutoSock® (fabric snow chain) only in pairs and on the rear tires. It should be noted that installing AutoSock (fabric snow chain) on the tires will provide a greater driving force, but will not prevent side skids.
- Do not install studded tires without first checking local, state and municipal regulations for possible restrictions against their use.

## Chain Installation

When installing AutoSock® (fabric snow chain), follow the manufacturer's instructions and mount them as tightly as possible. Drive slowly (less than 20 mph (30 km/h)) with AutoSock® installed. If you hear the fabric snow chains contacting the body or chassis, stop and tighten them. If they still make contact, slow down until the noise stops. Remove the AutoSock® as soon as you begin driving on cleared roads.

When mounting AutoSock®, park the vehicle on level ground away from traffic. Turn on the vehicle Hazard Warning Flasher and place a triangular emergency warning device behind the vehicle (if available).

Always place the vehicle in P (Park), apply the parking brake and turn off the engine before installing tire chains.

## NOTICE

When using AutoSock® (fabric snow chain):

- Wrong size fabric snow chains or improperly installed fabric snow chains can damage your vehicle's brake lines, suspension, body and wheels.
- If you hear noise caused by fabric snow chains contacting the body, retighten the fabric snow chains to prevent contact with the vehicle body.
- To prevent body damage, retighten the fabric snow chains after driving 0.3~0.6 miles (0.5~1.0 km).

### Winter Precautions

#### Use high quality ethylene glycol coolant

Your vehicle is delivered with high quality ethylene glycol coolant in the cooling system. It is the only type of coolant that should be used because it helps prevent corrosion in the cooling system, lubricates the water pump and prevents freezing. Be sure to replace or replenish your coolant in accordance with the maintenance schedule in chapter 9. Before winter, have your coolant tested to assure that its freezing point is sufficient for the temperatures anticipated during the winter.

#### Check battery and cables

Winter temperatures affect battery performance. **Inspect the battery and cables, as specified in chapter 9.** The battery charging level can be checked by an authorized retailer of Genesis Branded products or in a service station.

#### Change to “winter weight” oil if necessary

In some regions during winter, it is recommended to use the “winter weight” oil with lower viscosity. In addition, replace the engine oil and filter if it is close to the next maintenance interval. Fresh engine oil ensures optimum engine operation during the winter months. For further information, refer to chapter 2. When you are not sure about a type of winter weight oil, consult an authorized retailer of Genesis Branded products.

#### Check spark plugs and ignition system

**Inspect the spark plugs, as specified in chapter 9.** If necessary, replace them. Also check all ignition wirings and components for any cracks, wear-out, and damage.

#### To prevent locks from freezing

To prevent the locks from being frozen, spray approved de-icing fluid or glycerin into key holes. When a lock opening is already covered with ice, spray approved de-icing fluid over the ice to remove it. When an internal part of a lock freezes, try to thaw it with a heated key. Carefully use the heated key to avoid an injury.

#### Use approved window washer anti-freeze solution in system

To prevent the window washer from being frozen, add authorized window washer anti-freeze solution, as specified on the window washer container. Window washer anti-freeze solution is available from an authorized retailer of Genesis Branded products, and most vehicle accessory outlets. Do not use engine coolant or other types of anti-freeze solution, to prevent any damage to the vehicle paint.

**Do not let your parking brake freeze**

Under some conditions your parking brake can freeze in the engaged position. This is most likely to happen when there is an accumulation of snow or ice around or near the rear brakes or if the brakes are wet. When there is the risk that your parking brake may freeze, temporarily apply it with the gear in P (Park). Also, block the rear wheels in advance, so the vehicle may not roll. Then, release the parking brake.

**Do not let ice and snow accumulate underneath**

Under some conditions, snow and ice can build up under the fenders and interfere with the steering. When driving in such conditions during the severe winter, you should check underneath the vehicle on a regular basis, to ensure that the front wheels and the steering components is unblocked.

**Carry emergency equipment**

In accordance with weather conditions, you should carry appropriate emergency equipment, while driving. Some of the items you may want to carry include tire chains, tow straps or chains, flashlight, emergency flares, sand, shovel, jumper cables, window scraper, gloves, ground cloth, coveralls, blanket, etc.

**Do not place objects or materials in the engine compartment**

Putting objects or materials in the engine compartment may cause an engine failure or combustion, because they may block the engine cooling. Such damage will not be covered by the manufacturer's warranty.

## VEHICLE LOAD LIMIT

Two labels on your driver's door sill show how much weight your vehicle was designed to carry: the Tire and Loading Information Label and the Certification Label.

Before loading your vehicle, familiarize yourself with the following terms for determining your vehicle's weight ratings, from the vehicle's specifications and the Certification Label:

### **Base curb weight**

This is the weight of the vehicle including a full tank of fuel and all standard equipment. It does not include passengers, cargo, or optional equipment.

### **Vehicle curb weight**

This is the weight of your new vehicle when you picked it up from your dealer plus any aftermarket equipment.

### **Cargo weight**

This figure includes all weight added to the Base Curb Weight, including cargo and optional equipment.

### **GAW (Gross Axle Weight)**

This is the total weight placed on each axle (front and rear) - including vehicle curb weight and all payload.

### **GAWR (Gross Axle Weight Rating)**

This is the maximum allowable weight that can be carried by a single axle (front or rear). These numbers are shown on the Certification Label. The total load on each axle must never exceed its GAWR.

### **GVW (Gross Vehicle Weight)**

This is the Base Curb Weight plus actual Cargo Weight plus passengers.

### **GVWR (Gross Vehicle Weight Rating)**

This is the maximum allowable weight of the fully loaded vehicle (including all options, equipment, passengers and cargo). The GVWR is shown on the Certification Label located on the driver's door sill.



## The Loading Information Label

### ■ Type A

TIRE AND LOADING INFORMATION RENSEIGNEMENTS SUR LES PNEUS ET LE CHARGEMENT				
SEATING CAPACITY NOMBRE DE PLACES		TOTAL 5	FRONT AVANT 2	REAR ARRIÈRE 3
The combined weight of occupants and cargo should never exceed 410 kg or 904 lbs. Le poids total des occupants et du chargement ne doit jamais dépasser 410 kg ou 904 lb.				
TIRE PNEU	SIZE DIMENSIONS	COLD TIRE PRESSURE PRESSION DES PNEUS À FROID	SEE OWNER'S MANUAL FOR ADDITIONAL INFORMATION	
FRONT AVANT	225/40ZR19	250kpa, 36psi	VOIR LE MANUEL DE L'USAGER POUR PLUS DE RENSEIGNEMENTS	
REAR ARRIÈRE	255/35ZR19	250kpa, 36psi		
SPARE DE SECOURS	T135/80R18	420kPa, 60psi		

OIK057176N

### ■ Type B

TIRE AND LOADING INFORMATION RENSEIGNEMENTS SUR LES PNEUS ET LE CHARGEMENT				
SEATING CAPACITY NOMBRE DE PLACES		TOTAL 5	FRONT AVANT 2	REAR ARRIÈRE 3
The combined weight of occupants and cargo should never exceed 410 kg or 904 lbs. Le poids total des occupants et du chargement ne doit jamais dépasser 410 kg ou 904 lb.				
TIRE PNEU	SIZE DIMENSIONS	COLD TIRE PRESSURE PRESSION DES PNEUS À FROID	SEE OWNER'S MANUAL FOR ADDITIONAL INFORMATION	
FRONT AVANT	225/40R19	250kpa, 36psi	VOIR LE MANUEL DE L'USAGER POUR PLUS DE RENSEIGNEMENTS	
REAR ARRIÈRE	255/35R19	250kpa, 36psi		
SPARE DE SECOURS	T135/80R18	420kPa, 60psi		

OIK059165N

### ■ Type C

TIRE AND LOADING INFORMATION RENSEIGNEMENTS SUR LES PNEUS ET LE CHARGEMENT				
SEATING CAPACITY NOMBRE DE PLACES		TOTAL 5	FRONT AVANT 2	REAR ARRIÈRE 3
The combined weight of occupants and cargo should never exceed 410 kg or 904 lbs. Le poids total des occupants et du chargement ne doit jamais dépasser 410 kg ou 904 lb.				
TIRE PNEU	SIZE DIMENSIONS	COLD TIRE PRESSURE PRESSION DES PNEUS À FROID	SEE OWNER'S MANUAL FOR ADDITIONAL INFORMATION	
FRONT AVANT	225/40ZR19	250kpa, 36psi	VOIR LE MANUEL DE L'USAGER POUR PLUS DE RENSEIGNEMENTS	
REAR ARRIÈRE	255/35ZR19	250kpa, 36psi		
SPARE DE SECOURS	T135/80R18	420kPa, 60psi		

OIK057177N

### ■ Type D

TIRE AND LOADING INFORMATION RENSEIGNEMENTS SUR LES PNEUS ET LE CHARGEMENT				
SEATING CAPACITY NOMBRE DE PLACES		TOTAL 5	FRONT AVANT 2	REAR ARRIÈRE 3
The combined weight of occupants and cargo should never exceed 410 kg or 904 lbs. Le poids total des occupants et du chargement ne doit jamais dépasser 410 kg ou 904 lb.				
TIRE PNEU	SIZE DIMENSIONS	COLD TIRE PRESSURE PRESSION DES PNEUS À FROID	SEE OWNER'S MANUAL FOR ADDITIONAL INFORMATION	
FRONT AVANT	225/40R19	260kpa, 38psi	VOIR LE MANUEL DE L'USAGER POUR PLUS DE RENSEIGNEMENTS	
REAR ARRIÈRE	255/35R19	250kpa, 36psi		
SPARE DE SECOURS	T135/80R18	420kPa, 60psi		

OIK059166N

### ■ Type E

TIRE AND LOADING INFORMATION RENSEIGNEMENTS SUR LES PNEUS ET LE CHARGEMENT				
SEATING CAPACITY NOMBRE DE PLACES		TOTAL 5	FRONT AVANT 2	REAR ARRIÈRE 3
The combined weight of occupants and cargo should never exceed 410 kg or 904 lbs. Le poids total des occupants et du chargement ne doit jamais dépasser 410 kg ou 904 lb.				
TIRE PNEU	SIZE DIMENSIONS	COLD TIRE PRESSURE PRESSION DES PNEUS À FROID	SEE OWNER'S MANUAL FOR ADDITIONAL INFORMATION	
FRONT AVANT	225/45R18	250kpa, 36psi	VOIR LE MANUEL DE L'USAGER POUR PLUS DE RENSEIGNEMENTS	
REAR ARRIÈRE	225/45R18	270kpa, 39psi		
SPARE DE SECOURS	T135/80R18	420kPa, 60psi		

OIK057174N

The label located on the driver's door sill gives the original tire size, cold tire pressures recommended for your vehicle, the number of people that can be in your vehicle and vehicle capacity weight.

### **Vehicle capacity weight**

904 lbs. (410 kg)

Vehicle capacity weight is the maximum combined weight of occupants and cargo. If your vehicle is equipped with a trailer, the combined weight includes the tongue load.

### **Seating capacity**

Total : 5 persons (Front seat : 2 persons,  
Rear seat : 3 persons)

Seating capacity is the maximum number of occupants including a driver, your vehicle may carry. However, the seating capacity may be reduced based upon the weight of all of the occupants, and the weight of the cargo being carried or towed. Do not overload the vehicle as there is a limit to the total weight, or load limit including occupants and cargo, the vehicle can carry.

### **Towing capacity**

We do not recommend using this vehicle for trailer towing.

### **Cargo capacity**

The cargo capacity of your vehicle will increase or decrease depending on the weight and the number of occupants and the tongue load, if your vehicle is equipped with a trailer.







### **Steps for determining correct load limit**

1. Locate the statement "The combined weight of occupants and cargo should never exceed XXX kg or XXX lbs." on your vehicle's placard.
2. Determine the combined weight of the driver and passengers that will be riding in your vehicle.
3. Subtract the combined weight of the driver and passengers from XXX kg or XXX lbs.
4. The resulting figure equals the available amount of cargo and luggage load capacity. For example, if the "XXX" amount equals 1400 lbs. and there will be five 150 lb passengers in your vehicle, the amount of available cargo and luggage load capacity is 650 lbs. (1400 - 750 (5 x 150) = 650 lbs.)
5. Determine the combined weight of luggage and cargo being loaded on the vehicle. That weight may not safely exceed the available cargo and luggage load capacity calculated in Step 4.
6. If your vehicle will be towing a trailer, load from your trailer will be transferred to your vehicle. Consult this manual to determine how this reduces the available cargo and luggage load capacity of your vehicle.



### **WARNING**

**Do not overload the vehicle as there is a limit to the total weight, or load limit, including occupants and cargo, the vehicle can carry. Overloading can shorten the life of the vehicle. If the GVWR or the GAWR is exceeded, parts on the vehicle can break, and it can change the handling of your vehicle. These could cause you to lose control and result in an accident.**

<p><b>Example 1</b></p>	<p>Vehicle Capacity</p> <p>Maximum Load (1400 lbs.) (635 kg)</p>	<p>≈</p>	<p></p> <p>Passenger Weight (150 lbs. × 2 = 300 lbs.) (68 kg × 2 = 136 kg)</p>	<p>+</p>	<p></p> <p>Cargo Weight (1100 lbs.) (499 kg)</p>
<p><b>Example 2</b></p>	<p>Vehicle Capacity</p> <p>Maximum Load (1400 lbs.) (635 kg)</p>	<p>≈</p>	<p></p> <p>Passenger Weight (150 lbs. × 5 = 750 lbs.) (68 kg × 5 = 340 kg)</p>	<p>+</p>	<p></p> <p>Cargo Weight (650 lbs.) (295 kg)</p>
<p><b>Example 3</b></p>	<p>Vehicle Capacity</p> <p>Maximum Load (1400 lbs.) (635 kg)</p>	<p>≈</p>	<p></p> <p>Passenger Weight (172 lbs. × 5 = 860 lbs.) (78 kg × 5 = 390 kg)</p>	<p>+</p>	<p></p> <p>Cargo Weight (540 lbs.) (245 kg)</p>

### Certification label



The certification label is located on the driver's door sill at the center pillar and shows the maximum allowable weight of the fully loaded vehicle. This is called the GVWR (Gross Vehicle Weight Rating). The GVWR includes the weight of the vehicle, all occupants, fuel and cargo.

This label also tells you the maximum weight that can be supported by the front and rear axles, called Gross Axle Weight Rating (GAWR).

The total weight of the vehicle, including all occupants, accessories, cargo, and trailer tongue load must not exceed the Gross Vehicle Weight Rating (GVWR) or the Gross Axle Weight Rating (GAWR).

To find out the actual loads on your front and rear axles, you need to go to a weigh station and weigh your vehicle. Be sure to spread out your load equally on both sides of the centerline.

### WARNING

#### Overloading

- Never exceed the GVWR for your vehicle, the GAWR for either the front or rear axle and vehicle capacity weight. Exceeding these ratings can affect your vehicle's handling and braking ability, and cause an accident.
- Do not overload your vehicle. Overloading your vehicle can cause heat buildup in your vehicle's tires and possible tire failure, increased stopping distances and poor vehicle handling—all of which may result in a crash.

### **NOTICE**

Overloading your vehicle may cause damage. Repairs would not be covered by your warranty. Do not overload your vehicle.

**WARNING**

If you carry items inside your vehicle (e.g., suitcases, tools, packages, or anything else), they are moving as fast as the vehicle. If you have to stop or turn quickly, or if there is a crash, the items will keep going and can cause an injury if they strike the driver or a passenger.

- Put items in the cargo area of your vehicle. Try to spread the weight evenly.
- Do not stack items, like suitcases, inside the vehicle above the tops of the seats.
- Do not leave an unsecured child restraint in your vehicle.
- When you carry something inside the vehicle, secure it.

**TRAILER TOWING**

We do not recommend using this vehicle for trailer towing.

# 7. Driver assistance system

Driving Safety	
Forward Collision-Avoidance Assist (FCA) (Sensor fusion) .....	7-2
Lane Keeping Assist (LKA) .....	7-17
Blind-Spot Collision-Avoidance Assist (BCA) .....	7-23
Safe Exit Warning (SEW) .....	7-37
Driver Attention Warning (DAW).....	7-43
Blind-Spot View Monitor (BVM) .....	7-50
Driving Convenience	
Smart Cruise Control (SCC) .....	7-52
Navigation-based Smart Cruise Control (NSCC).....	7-69
Lane Following Assist (LFA).....	7-76
Highway Driving Assist (HDA) .....	7-80
Parking Safety	
Rear View Monitor (RVM).....	7-87
Surround View Monitor (SVM) .....	7-90
Rear Cross-Traffic Collision-Avoidance Assist (RCCA) .....	7-95
Reverse Parking Distance Warning (PDW).....	7-106
Forward/Reverse Parking Distance Warning (PDW) .....	7-109
Declaration of Conformity.....	7-114

## FORWARD COLLISION-AVOIDANCE ASSIST (FCA) (SENSOR FUSION)

### Basic function

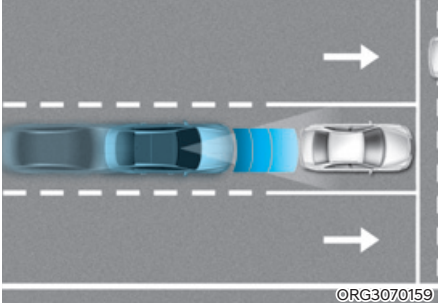

Forward Collision-Avoidance Assist is designed to help detect and monitor the vehicle ahead or help detect a pedestrian or cyclist in the roadway and warn the driver that a collision is imminent with a warning message and an audible warning, and if necessary, apply emergency braking.

### Junction Turning function

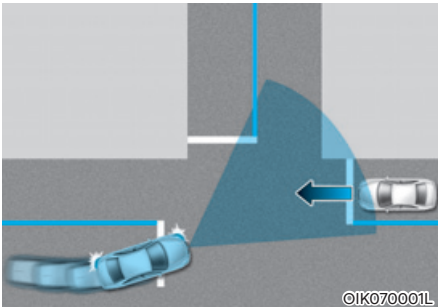

Junction Turning function will help avoid a collision with an oncoming vehicle in an adjacent lane when turning left at a crossroad with the turn signal on by applying emergency braking.

### Detecting sensor

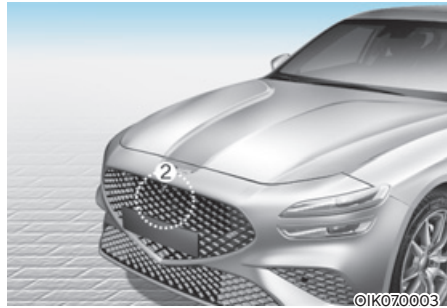
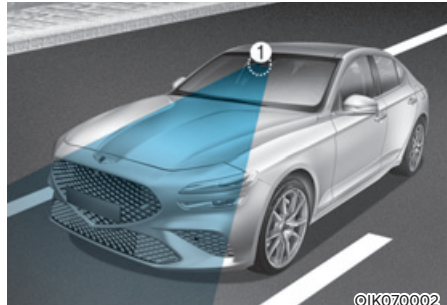

[1] : Front view camera,  
[2] : Front radar

Refer to the picture above for the detailed location of the detecting sensors.

### CAUTION

Take the following precautions to maintain optimal performance of the detecting sensor:

- **Never disassemble the detecting sensor or sensor assembly, or apply any impact on it.**
- **If the detecting sensors have been replaced or repaired, have the system inspected by an authorized retailer of Genesis Branded products.**
- **Never install any accessories or stickers on the front windshield, or tint the front windshield.**

- Pay extreme caution to keep the front view camera dry.
- Never place any reflective objects (i.e. white paper, mirror) over the dashboard.
- Do not apply license plate frame or objects, such as a bumper sticker, film or a bumper guard, near the front radar cover.
- Always keep the front radar and cover clean and free of dirt and debris.  
Use only a soft cloth to wash the vehicle. Do not spray pressurized water directly on the sensor or sensor cover.
- If unnecessary force has been applied to the radar or around the radar, Forward Collision-Avoidance Assist may not properly operate even though a warning message does not appear on the cluster. Have the system inspected by an authorized retailer of Genesis Branded products.
- Use only genuine parts to repair or replace a damaged front radar cover. Do not apply paint to the front radar cover.

## Forward Collision-Avoidance Assist Settings

### Setting features

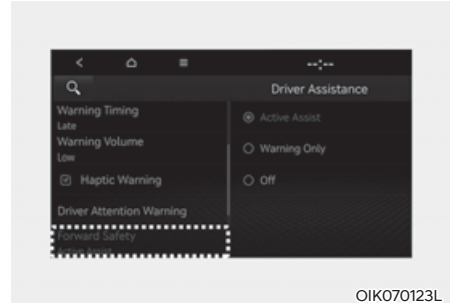

### Forward Safety

With the engine on, select or deselect 'Driver Assistance → Forward Safety' from the Settings menu to set whether or not to use each function.

- If 'Active Assist' is selected, Forward Collision-Avoidance Assist will warn the driver with a warning message, an audible warning and steering wheel vibration depending on the collision risk levels. Braking assist will be applied depending on the collision risk.
- If 'Warning Only' is selected, Forward Collision-Avoidance Assist will warn the driver with a warning message, an audible warning and steering wheel vibration depending on the collision risk levels. Braking will not be assisted. The driver must apply the brake pedal or steer the vehicle if necessary.
- If 'Off' is selected, Forward Collision-Avoidance Assist will turn off. The warning light will illuminate on the cluster.

The driver can monitor Forward Collision-Avoidance Assist ON/OFF status from the Settings menu. If the warning light remains ON when Forward Collision-Avoidance Assist is ON, have the vehicle inspected by an authorized retailer of Genesis Branded products.



 **WARNING**

When the engine is restarted, Forward Collision-Avoidance Assist will always turn on. However, if 'Off' is selected after the engine is restarted, the driver should always be aware of the surroundings and drive safely.

 **CAUTION**

- If 'Warning Only' is selected, braking is not assisted.
- The settings for Forward Safety include 'Basic function' and 'Junction Turing (if equipped)

 **Information**

Forward Collision-Avoidance Assist will turn off when ESC is turned off by pressing and holding the ESC OFF button for more than 3 seconds. The  warning light will illuminate on the cluster.

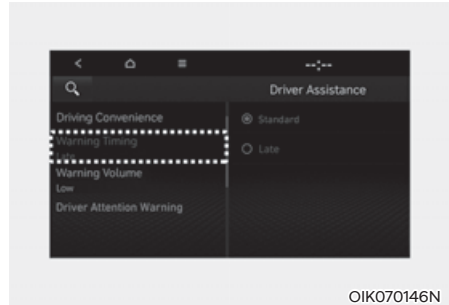

**Warning Timing**

With the engine on, select 'Driver Assistance → Warning Timing' from the Settings menu to change the initial warning activation time for Forward Collision-Avoidance Assist.

When the vehicle is first delivered, Warning Timing is set to 'Standard'. If you change the Warning Timing, the warning time of other Driver Assistance systems may change.

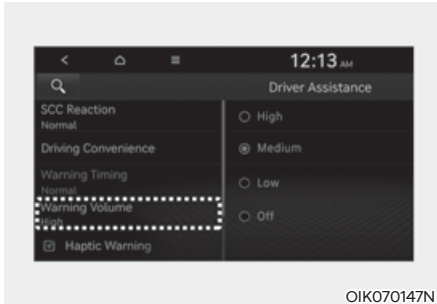

OIK070147N

### Warning Volume

With the engine on, select 'Driver Assistance → Warning Volume' from the Settings menu to change the Warning Volume to 'High', 'Medium', 'Low' or 'Off' for Forward Collision-Avoidance Assist.

However, even if 'Off' is selected, Warning Volume of Forward Collision Avoidance Assist will not turn off but the volume will sound as 'Low'.

If you change the warning volume, the Warning Volume of other Driver Assistance systems may change.

### CAUTION

- The setting of the Warning Timing and Warning Volume applies to all functions of Forward Collision-Avoidance Assist.
- Even though 'Standard' is selected for Warning Timing, if the front vehicle suddenly stops, the initial warning activation time may not seem late.
- Select 'Late' for Warning Timing when traffic is light and when driving speed is slow.

### Information

If the engine is restarted, Warning Timing and Warning Volume will maintain the last setting.

## Forward Collision-Avoidance Assist Operation

### Basic function

#### Warning and control

The basic function for Forward Collision-Avoidance Assist is to help warn and control the vehicle depending on the collision level: 'Collision Warning', 'Emergency Braking' and 'Stopping vehicle and ending brake control'.

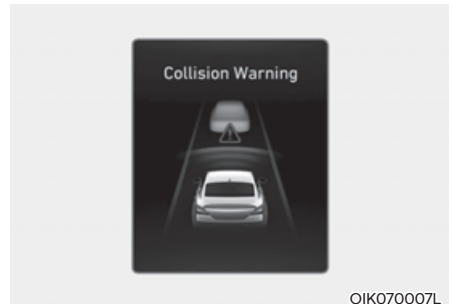

OIK070007L

#### Collision Warning

- To warn the driver of a collision, the 'Collision Warning' warning message will appear on the cluster, an audible warning will sound and the steering wheel will vibrate.
- If a vehicle is detected in front, the function will operate when your vehicle speed is between approximately 6~120 mph (10~200km/h).
- If a pedestrian or cyclist is detected in front, the function will operate when your vehicle speed is between approximately 6~53 mph (10~85 km/h).
- If 'Active Assist' is selected, braking may be assisted.

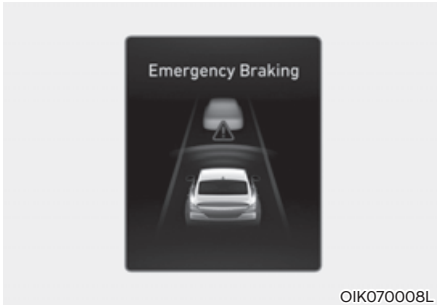

### Emergency Braking

- To warn the driver that emergency braking will be assisted, the 'Emergency Braking' warning message will appear on the cluster, an audible warning will sound and the steering wheel will vibrate.
- If a vehicle is detected in front, the function will operate when your vehicle speed is between approximately 6~47 mph (10~75 km/h).
- If a pedestrian or cyclist is detected in front, the function will operate when your vehicle speed is between approximately 6~40 mph (10~65 km/h).
- In emergency braking situation, braking is assisted with strong braking power by the function to help prevent collision with the vehicle, pedestrian or cyclist ahead.



### Stopping vehicle and ending brake control

- When the vehicle is stopped due to emergency braking, the 'Drive carefully' warning message will appear on the cluster.  
For your safety, the driver should depress the brake pedal immediately and check the surroundings.
- Brake control will end after the vehicle is stopped by emergency braking for approximately 2 seconds.

## Junction Turning function

### Warning and control

Junction Turning function will help warn and control the vehicle depending on the collision level: 'Collision Warning', 'Emergency Braking' and 'Stopping vehicle and ending brake control'



### Collision Warning

- To warn the driver of a collision, the 'Collision Warning' warning message will appear on the cluster and an audible warning will sound.
- The function will operate when your vehicle speed is between approximately 6~19 mph (10~30 km/h) and the oncoming vehicle speed is between approximately 19~44 mph (30~70 km/h).
- If 'Active Assist' is selected, braking may be assisted.

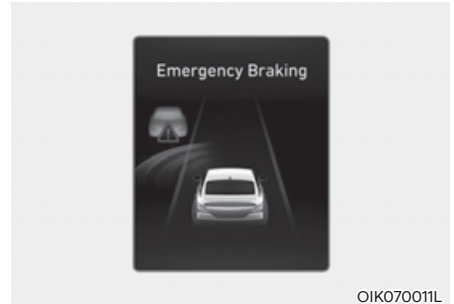

### Emergency Braking

- To warn the driver that emergency braking will be assisted, the 'Emergency Braking' warning message will appear on the cluster and an audible warning will sound.
- The function will operate when your vehicle speed is between approximately 6~19 mph (10~30 km/h) and the oncoming vehicle speed is between approximately 19~44 mph (30~70 km/h).
- In emergency braking situation, braking is assisted with strong braking power by the function to help prevent collision with the oncoming vehicle.



### Stopping vehicle and ending brake control

- When the vehicle is stopped due to emergency braking, the 'Drive carefully' warning message will appear on the cluster.  
For your safety, the driver should depress the brake pedal immediately and check the surroundings.
- Brake control will end after the vehicle is stopped by emergency braking for approximately 2 seconds.

### **WARNING**

Take the following precautions when using Forward Collision-Avoidance Assist:

- For your safety, change the Settings after parking the vehicle at a safe location.
- With 'Active Assist' or 'Warning Only' selected, when ESC is turned off by pressing and holding the ESC OFF button for more than 3 seconds, Forward Collision-Avoidance Assist will turn off automatically. In this case, Forward Collision-Avoidance Assist cannot be set from the Settings menu and the  warning light will illuminate on the cluster which is normal. If ESC is turned on by pressing the ESC OFF button, Forward Collision-Avoidance Assist will maintain the last setting.
- Forward Collision-Avoidance Assist does not operate in all situations or cannot avoid all collisions.
- The driver should hold the responsibility to control the vehicle. Do not solely depend on Forward Collision-Avoidance Assist. Rather, maintain a safe braking distance, and if necessary, depress the brake pedal to reduce driving speed or to stop the vehicle.
- Never deliberately operate Forward Collision-Avoidance Assist on people, objects, etc. It may cause serious injury or death.
- Forward Collision-Avoidance Assist may not operate if the driver depresses the brake pedal to avoid collision.

- Depending on the road and driving conditions, Forward Collision-Avoidance Assist may warn the driver late or may not warn the driver.
- During Forward Collision-Avoidance Assist operation, the vehicle may stop suddenly injuring passengers and shifting loose objects. Always have the seat belt on and keep loose objects secured.
- If any other system's warning message is displayed or audible warning is generated, Forward Collision-Avoidance Assist warning message may not be displayed and audible warning may not be generated.
- You may not hear the warning sound of Forward Collision-Avoidance Assist if the surrounding is noisy.
- Forward Collision-Avoidance Assist may turn off or may not operate properly or may operate unnecessarily depending on the road conditions and the surroundings.

### WARNING

- Even if there is a problem with Forward Collision-Avoidance Assist, the vehicle's basic braking performance will operate normally.
- During emergency braking, braking control by Forward Collision-Avoidance Assist will automatically cancel when the driver excessively depresses the accelerator pedal or sharply steers the vehicle.

### CAUTION

- Forward Collision-Avoidance Assist operating speed range may reduce due to the conditions of the vehicle or pedestrian in front or surroundings. Depending on the speed, Forward Collision-Avoidance Assist may only warn the driver, or it may not operate.
- Forward Collision-Avoidance Assist will operate under certain conditions by judging the risk level based on the condition of the oncoming vehicle, driving direction, speed and surroundings.



### Information

In a situation where collision is imminent, braking may be assisted by Forward Collision-Avoidance Assist when braking is insufficient by the driver.

## Forward Collision-Avoidance Assist Malfunction and Limitations

### Forward Collision-Avoidance Assist malfunction



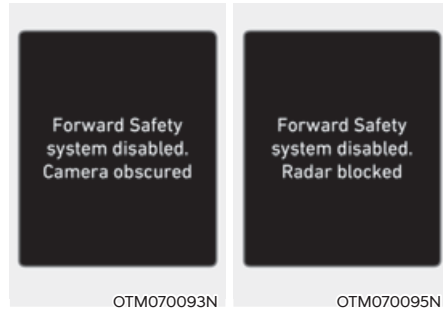

When Forward Collision-Avoidance Assist is not working properly, the 'Check Forward Safety system' warning message will appear, and the  and  warning lights will illuminate on the cluster. Have the vehicle inspected by an authorized retailer of Genesis Branded products.

### Forward Collision-Avoidance Assist disabled



When the front windshield where the front view camera is located, front radar cover or sensor is covered with foreign material, such as snow or rain, it can reduce the detecting performance and temporarily limit or disable Forward Collision-Avoidance Assist.

If this occurs the 'Forward Safety system disabled. Camera obscured' or the 'Forward Safety system disabled. Radar blocked' warning message, and the  and  warning lights will illuminate on the cluster.

Forward Collision-Avoidance Assist will operate normally when such snow, rain or foreign material is removed.

If Forward Collision-Avoidance Assist does not operate normally after obstruction (snow, rain, or foreign material) is removed, have the vehicle inspected by an authorized retailer of Genesis Branded products.

### WARNING

- Even though the warning message or warning light does not appear on the cluster, Forward Collision-Avoidance Assist may not properly operate.
- Forward Collision-Avoidance Assist may not properly operate in an area (e.g. open terrain), where any substance are not detected after turning ON the engine.

### ***Limitations of Forward Collision-Avoidance Assist***

Forward Collision-Avoidance Assist may not operate normally, or it may operate unexpectedly under the following circumstances:

- The detecting sensor or the surroundings are contaminated or damaged
- The temperature around the front view camera is high or low
- The camera lens is contaminated due to tinted, filmed or coated windshield, damaged glass, or stuck of foreign material (sticker, bug, etc.) on the glass
- Moisture is not removed or frozen on the windshield
- Washer fluid is continuously sprayed, or the wiper is on
- Driving in heavy rain or snow, or thick fog
- The field of view of the front view camera is obstructed by sun glare
- Street light or light from an oncoming vehicle is reflected on the wet road surface, such as a puddle on the road
- An object is placed on the dashboard
- Your vehicle is being towed
- The surrounding is very bright
- The surrounding is very dark, such as in a tunnel, etc.
- The brightness changes suddenly, for example when entering or exiting a tunnel
- The brightness outside is low, and the headlamps are not on or are not bright
- Driving through steam, smoke or shadow
- Only part of the vehicle, pedestrian or cyclist is detected
- The vehicle in front is a bus, heavy truck, truck with a unusually shaped luggage, trailer, etc.
- The vehicle in front has no tail lights, tail lights are located unusually, etc.
- The brightness outside is low, and the tail lamps are not on or are not bright
- The rear of the front vehicle is small or the vehicle does not look normal, such as when the vehicle is tilted, overturned, or the side of the vehicle is visible, etc.
- The front vehicle's ground clearance is low or high
- A vehicle, pedestrian or cyclist suddenly cuts in front
- The bumper around the front radar is impacted, damaged or the front radar is out of position
- The temperature around the front radar is high or low



- Driving through a tunnel or iron bridge
- Driving in large areas where there are few vehicles or structures (i.e. desert, meadow, suburb, etc.)
- Driving near areas containing metal substances, such as a construction zone, railroad, etc.
- A material is near that reflects very well on the front radar, such as a guardrail, nearby vehicle, etc.
- The cyclist in front is on a bicycle made of material that does not reflect on the front radar
- The vehicle in front is detected late
- The vehicle in front is suddenly blocked by an obstacle
- The vehicle in front suddenly changes lane or suddenly reduces speed
- The vehicle in front is bent out of shape
- The front vehicle's speed is fast or slow
- The vehicle in front steers in the opposite direction of your vehicle to avoid a collision
- With a vehicle in front, your vehicle changes lane at low speed
- The vehicle in front is covered with snow
- You are departing or returning to the lane
- Unstable driving
- You are on a roundabout and the vehicle in front is not detected
- You are continuously driving in a circle
- The vehicle in front has an unusual shape
- The vehicle in front is driving uphill or downhill

- The pedestrian or cyclist is not fully detected, for example, if the pedestrian is leaning over or is not fully walking upright
- The pedestrian or cyclist is wearing clothing or equipment that makes it difficult to detect as a pedestrian or cyclist

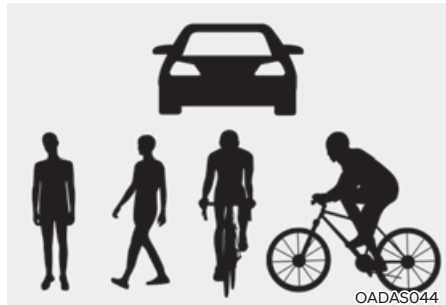

The illustration above shows the image the front view camera and front radar will detect as a vehicle, pedestrian and cyclist.

- The pedestrian or cyclist in front is moving very quickly
- The pedestrian or cyclist in front is short or is posing a low posture
- The pedestrian or cyclist in front has impaired mobility
- The pedestrian or cyclist in front is moving intersected with the driving direction
- There is a group of pedestrians, cyclists or a large crowd in front

- The pedestrian or cyclist is wearing clothing that easily blends into the background, making it difficult to detect
- The pedestrian or cyclist is difficult to distinguish from the similar shaped structure in the surroundings
- You are driving by a pedestrian, cyclist, traffic sign, structure, etc. near the intersection
- Driving in a parking lot
- Driving through a tollgate, construction area, unpaved road, partial paved road, uneven road, speed bumps, etc.
- Driving on an incline road, curved road, etc.
- Driving through a roadside with trees or streetlights
- The adverse road conditions cause excessive vehicle vibrations while driving
- Your vehicle height is low or high due to heavy loads, abnormal tire pressure, etc.
- Driving through a narrow road where trees or grass are overgrown
- There is interference by electromagnetic waves, such as driving in an area with strong radio waves or electrical noise

## WARNING

- Driving on a curve

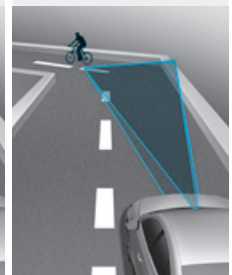
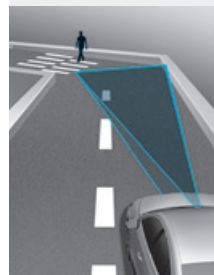
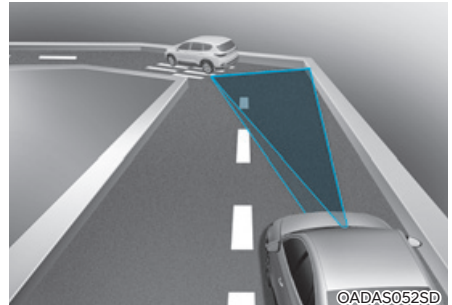

**Forward Collision-Avoidance Assist may not detect other vehicles, pedestrians or cyclists in front of you on curved roads adversely affecting the performance of the sensors. This may result in no warning or braking assist when necessary.**

**When driving on a curve, you must maintain a safe braking distance, and if necessary, steer the vehicle and depress the brake pedal to reduce your driving speed in order to maintain a safe distance.**

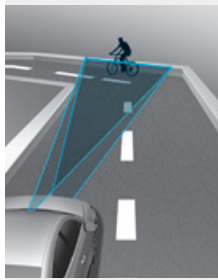
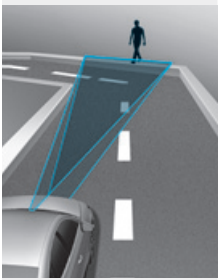
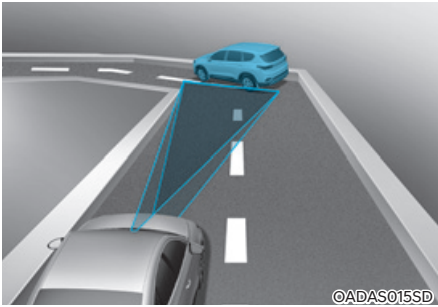

**Forward Collision-Avoidance Assist** may detect a vehicle, pedestrian or cyclist in the next lane or outside the lane when driving on a curved road. If this occurs, **Forward Collision-Avoidance Assist** may unnecessarily warn the driver and control the brake. Always check the traffic conditions around the vehicle.

- **Driving on a slope**

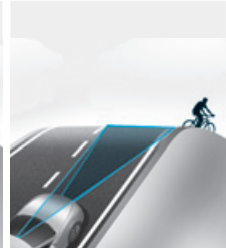
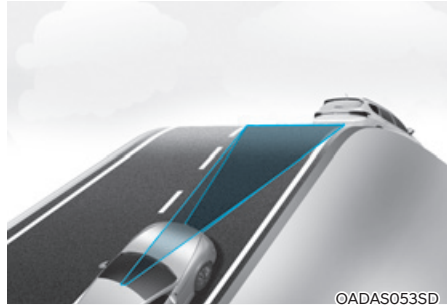

**Forward Collision-Avoidance Assist** may not detect other vehicles, pedestrians or cyclists in front of you while driving uphill or downhill adversely affecting the performance of the sensors.

This may result in unnecessary warning or braking assist, or no warning or braking assist when necessary.

Also, vehicle speed may rapidly decrease when a vehicle, pedestrian or cyclist ahead is suddenly detected.

Always have your eyes on the road while driving uphill or downhill and if necessary, steer your vehicle and depress the brake pedal to reduce your driving speed in order to maintain a safe distance.

- Changing lanes

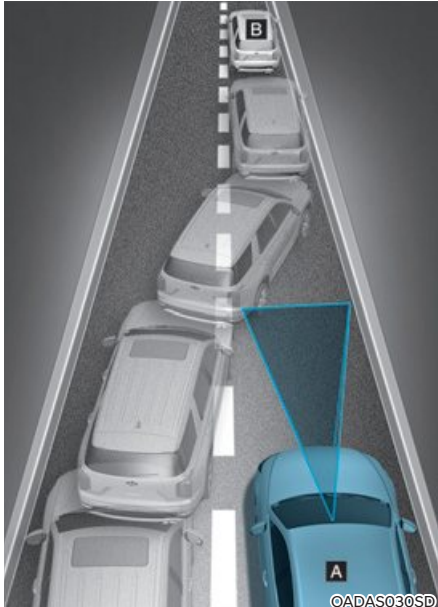

[A] : Your vehicle,

[B] : Lane changing vehicle

**When a vehicle moves into your lane from an adjacent lane, it cannot be detected by the sensor until it is in the sensor's detection range. Forward Collision-Avoidance Assist may not immediately detect the vehicle when the vehicle changes lanes abruptly. In this case, you must maintain a safe braking distance, and if necessary, steer your vehicle and depress the brake pedal to reduce your driving speed in order to maintain a safe distance.**

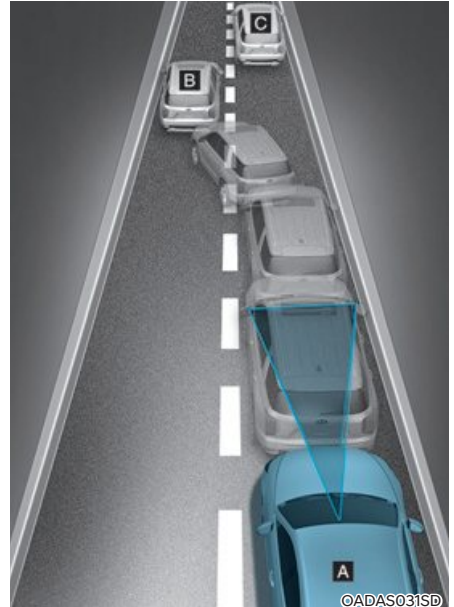

[A] : Your vehicle, [B] : Lane changing vehicle,

[C] : Same lane vehicle

**When a vehicle in front of you merges out of the lane, Forward Collision-Avoidance Assist may not immediately detect the vehicle that is now in front of you. In this case, you must maintain a safe braking distance, and if necessary, steer your vehicle and depress the brake pedal to reduce your driving speed in order to maintain a safe distance.**

- **Detecting vehicle**

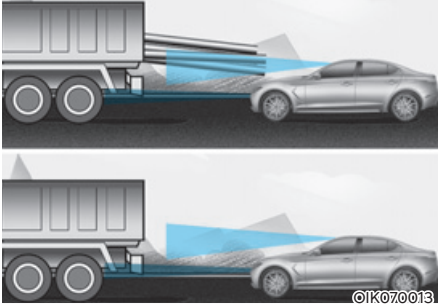

If the vehicle in front of you has cargo that extends rearward from the cab, or when the vehicle in front of you has higher ground clearance, additional special attention is required. Forward Collision-Avoidance Assist may not be able to detect the cargo extending from the vehicle. In these instances, you must maintain a safe braking distance from the rearmost object, and if necessary, steer your vehicle and depress the brake pedal to reduce your driving speed in order to maintain distance.

### **WARNING**

- If emergency towing is necessary, we recommend that Forward Collision-Avoidance Assist is turned off due to safety reasons.
- Forward Collision-Avoidance Assist may operate if objects that are similar in shape or characteristics to vehicles, pedestrians and cyclists are detected.
- Forward Collision-Avoidance Assist does not operate on bicycles, motorcycles, or smaller wheeled objects, such as luggage bags, shopping carts, or strollers.

- Forward Collision-Avoidance Assist may not operate normally if interfered by strong electromagnetic waves.
- Forward Collision-Avoidance Assist may not operate for 15 seconds after the vehicle is started, or the front view camera is initialized.

### **Information**

This device complies with Part 15 of the FCC rules.

Operation is subject to the following three conditions:

1. This device may not cause harmful interference, and
2. This device must accept any interference received, including interference that may cause undesired operation.
3. Changes or modifications not expressly approved by the party responsible for compliance could void the user's authority to operate the device.

### **Information**

Radio frequency radiation exposure information:

This equipment complies with FCC radiation exposure limits set forth for an uncontrolled environment.

This equipment should be installed and operated with minimum distance of 8 in. (20 cm) between the radiator (antenna) and your body.

This transmitter must not be co-located or operating in conjunction with any other antenna or transmitter.

## LANE KEEPING ASSIST (LKA)

Lane Keeping Assist is designed to help detect lane markings (or road edges) while driving over a certain speed. Lane Keeping Assist will warn the driver if the vehicle leaves the lane without using the turn signal, or will automatically assist the driver's steering to help prevent the vehicle from departing the lane.

### Detecting sensor

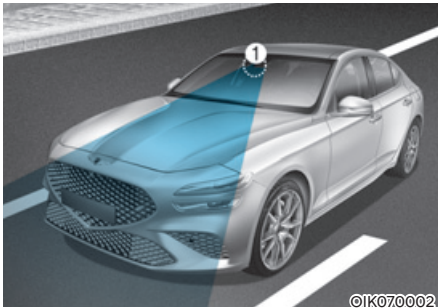

[1] : Front view camera

The front view camera is used as a detecting sensor to detect lane markings (or road edges).

Refer to the picture above for the detailed location of the detecting sensor.



### CAUTION

For more details on the precautions of the front view camera, refer to “Forward Collision-Avoidance Assist (FCA)” section in chapter 7.

## Lane Keeping Assist Settings

### Setting features

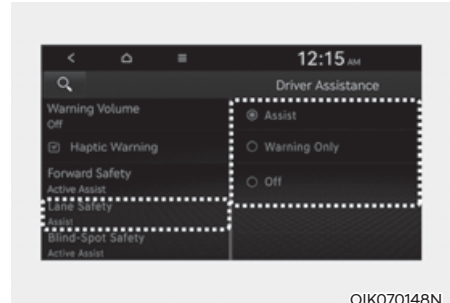

OIK070148N

### Lane Safety

With the engine on, select or deselect ‘Driver Assistance → Lane Safety’ from the Settings menu to set whether or not to use each function.

- If ‘Assist’ is selected, Lane Keeping Assist will automatically assist the driver's steering when lane departure is detected to help prevent the vehicle from moving out of its lane.
- If ‘Warning Only’ is selected, Lane Keeping Assist will warn the driver with an audible warning and steering wheel vibration when lane departure is detected. The driver must steer the vehicle.
- If ‘Off’ is selected, Lane Keeping Assist will turn off. The  indicator light will turn off on the cluster.



### WARNING

- If ‘Warning Only’ is selected, steering is not assisted.
- Lane Keeping Assist does not control the steering wheel when the vehicle is driven in the middle of the lane.
- The driver should always be aware of the surroundings and steer the vehicle if ‘Off’ is selected.

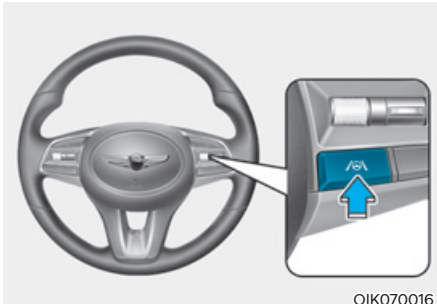

OIK070016

### Turning Lane Keeping Assist On/Off

With the engine on, press and hold the Lane Driving Assist button located on the steering wheel to turn on Lane Keeping Assist. The white  indicator light will illuminate on the cluster.

Press and hold the button again to turn off the system.

If the engine is restarted, Lane Keeping Assist will maintain the last setting.



### CAUTION

**When the Lane Driving Assist button is pressed shortly, Lane Following Assist will turn on and off.**

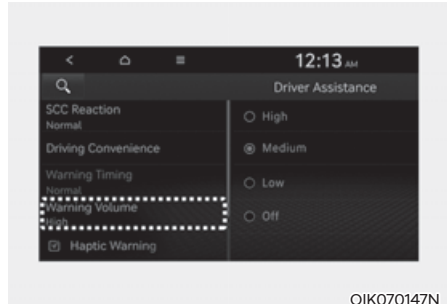

OIK070147N

### Warning Volume

With the engine on, select 'Driver Assistance → Warning Volume' from the Settings menu to change the Warning Volume to 'High', 'Medium', 'Low' or 'Off' for Lane Keeping Assist.

However, even if 'Off' is selected, the Hands-off Warning Volume will not be turned off. Steering wheel vibration function will also remain on even if 'Off' is selected.

If you change the Warning Volume, the Warning Volume of other Driver Assistance systems may be changed.

## Lane Keeping Assist Operation

### Warning and control

Lane Keeping Assist will help warn and control the vehicle with Lane Departure Warning and Lane Keeping Assist.

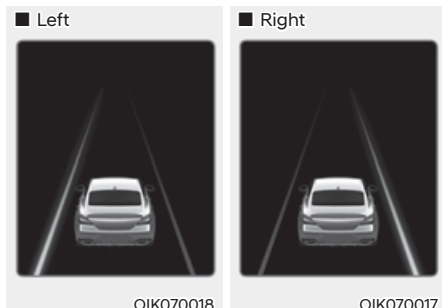

### Lane Departure Warning

- To warn the driver that the vehicle is departing from the projected lane in front, the green  indicator light will blink on the cluster, the lane line will blink on the cluster depending on which direction the vehicle is veering, and an audible warning will sound. Also, the steering wheel will vibrate.
- Lane Keeping Assist will operate when your vehicle speed is between approximately 40–120 mph (60–200 km/h).

### Lane Keeping Assist

- To warn the driver that the vehicle is departing from the projected lane in front, the green  indicator light will blink on the cluster, and the steering wheel will make adjustments to keep the vehicle inside the lane.
- Lane Keeping Assist will operate when your vehicle speed is between approximately 40–120 mph (60–200 km/h).

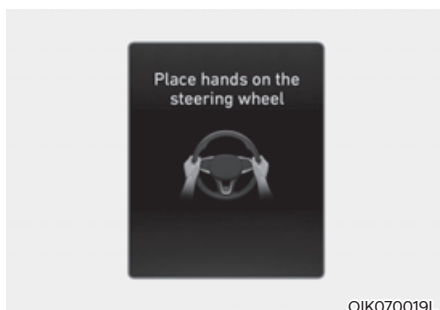

### Hands-off warning

If the driver takes their hands off the steering wheel for several seconds, the 'Place hands on the steering wheel' warning message will appear on the cluster, and an audible warning will sound in stages.



 **WARNING**

- The steering wheel may not be assisted if the steering wheel is held very tight or the steering wheel is steered over a certain degree.
- Lane Keeping Assist does not operate at all times. It is the responsibility of the driver to safely steer the vehicle and to maintain the vehicle in its lane.
- The hands-off warning message may appear late depending on road conditions. Always have your hands on the steering wheel while driving.
- If the steering wheel is held very lightly, the hands-off warning message may appear because Lane Keeping Assist may not recognize that the driver has their hands on the steering wheel.
- If you attach objects to the steering wheel, the hands-off warning may not work properly.

 **Information**

- You may change settings from the infotainment system (Vehicle Settings), whichever option that is provided with your vehicle. For more details, see "Vehicle Settings" section in supplied Infotainment Manual.
- When lane markings (or road edges) are detected, the lane lines on the cluster will change from grey to white and the green  indicator light will illuminate.

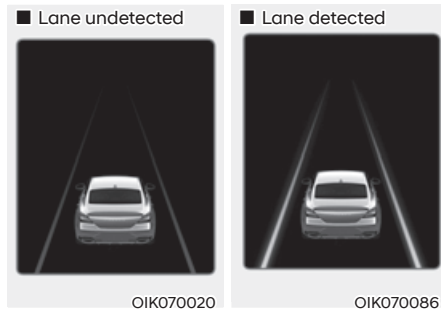

- Even though the steering is assisted by Lane Keeping Assist, the driver may control the steering wheel.
- The steering wheel may feel heavier or lighter when the steering wheel is assisted by Lane Keeping Assist than when it is not.

## Lane Keeping Assist Malfunction and Limitations

### Lane Keeping Assist malfunction

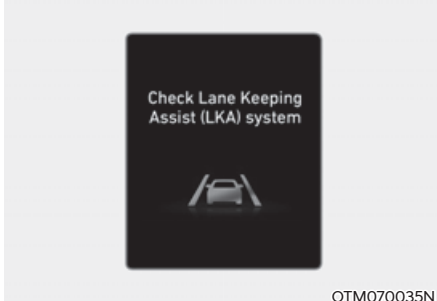

OTM070035N

When Lane Keeping Assist is not working properly, the 'Check Lane Keeping Assist (LKA) system' warning message will appear and the yellow  indicator light will illuminate on the cluster. If this occurs, have the vehicle inspected by an authorized retailer of Genesis Branded products.

### Limitations of Lane Keeping Assist

Lane Keeping Assist may not operate normally or may operate unexpectedly under the following circumstances:

- The lane is contaminated or difficult to distinguish because,
  - The lane markings (or road edge) is covered with rain, snow, dirt, oil, etc.
  - The color of the lane marking (or road edge) is not distinguishable from the road
  - There are markings (or road edges) on the road near the lane or the markings (or road edges) on the road looks similar to the lane markings (or road edge)
  - The lane marking (or road edge) is indistinct or damaged
  - The shadow is on the lane marking (or road edge) by a median strip, trees, guardrail, noise barriers, etc.
- The lane number increases or decreases, or the lane markings (or road edges) are crossing
- There are more than two lane markings (or road edges) on the road
- The lane markings (or road edges) are complicated or a structure substitutes for the lines, such as a construction area
- There are road markings, such as zigzag lanes, crosswalk markings and road signs
- The lane suddenly disappears, such as at the intersection
- The lane (or road width) is very wide or narrow

- There is a road edge without a lane
- There is a boundary structure in the roadway, such as a tollgate, sidewalk, curb, etc.
- The distance to the front vehicle is extremely short or the vehicle in front is covering the lane marking (or road edge)

### Information

For more details on the limitations of the front view camera, refer to “Forward Collision-Avoidance Assist (FCA)” section in chapter 7.

### WARNING

Take the following precautions when using Lane Keeping Assist:

- The driver should hold the responsibility to safely drive and control the vehicle. Do not solely rely on Lane Keeping Assist and drive dangerously.
- The operation of Lane Keeping Assist can be canceled or not work properly depending on road conditions and surroundings. Always be cautious while driving.
- Refer to “Limitations of Lane Keeping Assist” if the lane is not detected properly.
- If emergency towing is necessary, we recommend that Lane Keeping Assist is turned off due to safety reasons.
- If the vehicle is driven at high speed, the steering wheel will not be controlled. The driver must always follow the speed limit when using Lane Keeping Assist.
- If any other system’s warning message is displayed or audible warning is generated, Lane Keeping Assist warning message may not be displayed and audible warning may not be generated.
- You may not hear the warning sound of Lane Keeping Assist if the surrounding is noisy.
- If you attach objects to the steering wheel, steering may not be assisted properly.
- Lane Keeping Assist may not operate for 15 seconds after the vehicle is started, or the front view camera is initialized.
- Lane Keeping Assist will not operate when:
  - The turn signal or hazard warning flasher is turned on
  - The vehicle is not driven in the center of the lane when Lane Keeping Assist is turned on or right after changing a lane
  - ESC (Electronic Stability Control) or VSM (Vehicle Stability Management) is activated
  - The vehicle is driven on a sharp curve
  - The vehicle speed is below 35 mph (55 km/h) or above 130 mph (210 km/h)
  - The vehicle makes sharp lane changes
  - The vehicle brakes suddenly

## BLIND-SPOT COLLISION-AVOIDANCE ASSIST (BCA)

Blind-Spot Collision-Avoidance Assist is designed to help detect and monitor approaching vehicles in the driver's blind spot area and warn the driver of a possible collision with a warning message and audible warning.

In addition, if there is a risk of collision when changing lanes or driving forward out of a parking space, Blind-Spot Collision-Avoidance Assist will help avoid a collision by applying the brake.

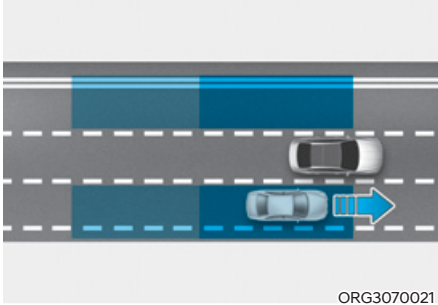

Blind-Spot Collision-Avoidance Assist helps detect and inform the driver that a vehicle is in the blind spot.

### CAUTION

The detecting range may vary depending on the speed of your vehicle. However, even if there is a vehicle in the blind spot area, Blind-Spot Collision-Avoidance Assist may not warn you when you pass by at high speeds.

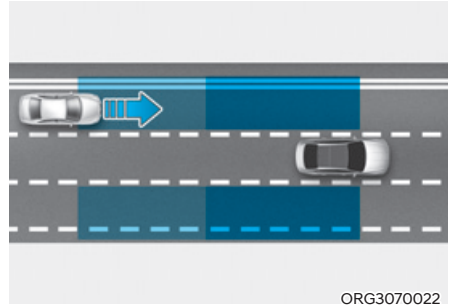

Blind-Spot Collision-Avoidance Assist helps detect and informs the driver that a vehicle is approaching at high speed from the blind spot area.

### CAUTION

Warning timing may vary depending on the speed of the vehicle approaching at high speed.

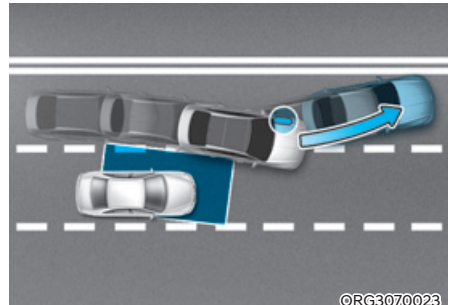

When changing lanes by detecting the lane ahead, if Blind-Spot Collision-Avoidance Assist judges that there is a collision risk with an approaching vehicle in the blind spot, it will help avoid a collision by applying the brake.

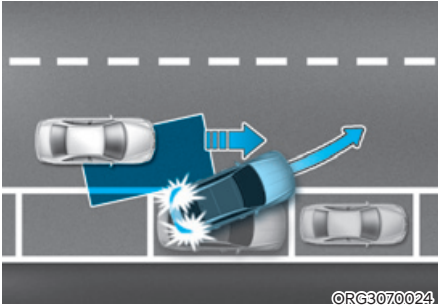

When you are driving forward out of a parking space, if Blind-Spot Collision-Avoidance Assist judges that there is a collision risk with an approaching vehicle in the blind spot, it will help avoid a collision by applying the brake.

### **i** Information

In the following text, Blind-Spot Collision-Avoidance Assist will be referred as Blind-Spot Safety system.

### **NOTICE**

In the following text, Blind-Spot Collision-Avoidance Assist will be referred as Blind-Spot Safety system.

### **Detecting sensor**

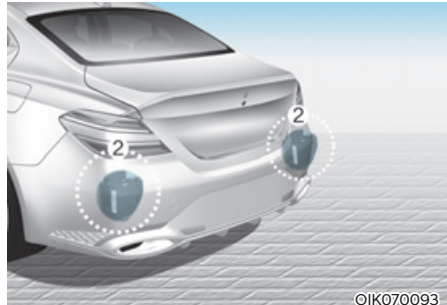
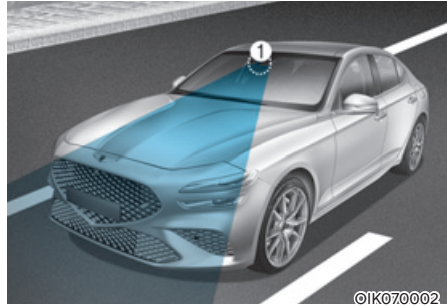

- [1] : Front view camera,
- [2] : Rear corner radar

Refer to the picture above for the detailed location of the detecting sensors.

### **⚠ CAUTION**

Take the following precautions to maintain optimal performance of the detecting sensor:

- Never disassemble the rear corner radar or radar assembly, or apply any impact on it.
- If there is impact on the rear corner radar or near the radar, even though the warning message does not appear on the cluster, Blind-Spot Safety system may not operate properly. Have the vehicle inspected by an authorized retailer of Genesis Branded products.

- If the rear corner radars have been replaced or repaired, have the system inspected by an authorized retailer of Genesis Branded products.
- Use only genuine parts to repair the rear bumper where the rear corner radar is located.
- Do not apply license plate frame or objects, such as a bumper sticker, film or a bumper guard near the rear corner radar.
- The system may not work properly if the bumper has been replaced, or the surroundings of the rear corner radar has been damaged or paint has been applied.
- If a trailer, carrier, etc. is installed, it may adversely affect the performance of the rear corner radar or the system may not operate.

### **i** Information

For more details on the precautions of the front view camera, refer to “Forward Collision-Avoidance Assist (FCA)” section in chapter 7.

## Blind-Spot Safety system Settings

### Setting features

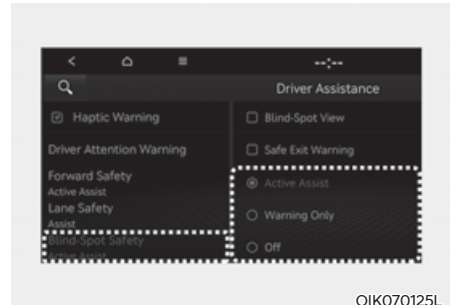

OIK070125L

### Blind-Spot Safety

With the engine on, select or deselect ‘Driver Assistance → Blind-Spot Safety’ from the Settings menu to set whether or not to use each function.

- If ‘Active Assist’ is selected, the system will warn the driver with a warning message, an audible warning, steering wheel vibration and braking assist will be applied depending on the collision risk levels.
- If ‘Warning Only’ is selected, the system will warn the driver with a warning message, an audible warning and steering wheel vibration depending on the collision risk levels. Braking will not be assisted.
- If ‘Off’ is selected, the system will turn off.



When the engine is restarted with the system off, the 'Blind-Spot Safety System is Off' message will appear on the cluster.

If you change the setting from 'Off' to 'Active Assist' or 'Warning Only', the warning light on the side view mirror will blink for three seconds.

In addition, if the engine is turned on, when the system is set to 'Active Assist' or 'Warning Only', the warning light on the side view mirror will blink for three seconds.

### WARNING

- If 'Warning Only' is selected, braking is not assisted.
- If 'Off' is selected, the driver should always be aware of the surroundings and drive safely.

### Information

If the engine is restarted, Blind-Spot Safety system will maintain the last setting.

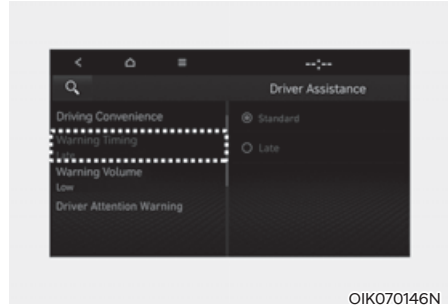

### Warning Timing

With the engine on, select 'Driver Assistance → Warning Timing' from the Settings menu to change the initial warning activation time for Blind-Spot Safety system.

When the vehicle is first delivered, Warning Timing is set to 'Standard'. If you change the Warning Timing, the warning time of other Driver Assistance systems may change.

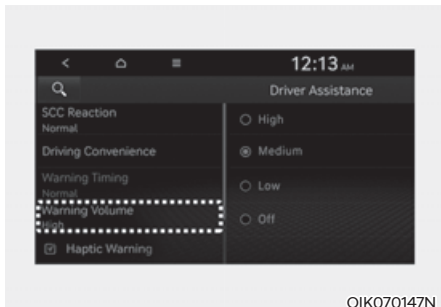

OIK070147N

### Warning Volume

With the engine on, select 'Driver Assistance → Warning Volume' from the Settings menu to change the Warning Volume to 'High', 'Medium', 'Low' or 'Off' for Blind-Spot Safety system.

However, when Warning Volume is turned off, the steering wheel vibration function will turn on if it was turned off.

If you change the Warning Volume, the warning volume of other Driver Assistance systems may change.



### CAUTION

- **The setting of the Warning Timing and Warning Volume applies to all functions of the Blind-Spot Safety system.**
- **Even though 'Standard' is selected for Warning Timing, if the vehicles approaches at high speed, the initial warning activation time may seem late.**
- **Select 'Late' for Warning Timing when traffic is light and when driving speed is slow.**

## Blind-Spot Safety system Operation

### Warning and control



©HY059005

### Vehicle detection

- To warn the driver, a vehicle is detected, the warning light on the side view mirror and head-up display (if equipped) will illuminate.
- The system will operate when your vehicle speed is above 12 mph (20 km/h) and the speed of the vehicle in the blind spot area is above 7 mph (10 km/h).



### Collision Warning

- Collision warning will operate when the turn signal is turned on in the direction of the detected vehicle.
- If 'Warning Only' is selected from the Settings menu, the collision warning will operate when your vehicle approaches the lane the blind spot vehicle is detected.
- To warn the driver of a collision, the warning light on the side view mirror and head-up display (if equipped) will blink. At the same time, an audible warning will sound and the steering wheel will vibrate.
- When the turn signal is turned off or you move away from the lane, the collision warning will be canceled and the system will return to vehicle detection state.



### WARNING

- **The detecting range of the rear corner radar is determined by a standard road width, therefore, on a narrow road, the system may detect other vehicles in the next lane and warn you. In contrast, on a wide road, the system may not be able to detect a vehicle driving in the next lane and may not warn you.**
- **When the hazard warning flasher is on, the collision warning by the turn signal will not operate.**



### Information

**If the driver's seat is on the left side, the collision warning may occur when you turn left. Maintain a proper distance with the vehicles in the left lane. If the driver's seat is on the right side, the collision warning may occur when you turn right. Maintain a proper distance with the vehicles in the right lane.**



#### Collision-Avoidance Assist (while driving)

- To warn the driver of a collision, the warning light on the side view mirror will blink and a warning message will appear on the cluster. At the same time, an audible warning will sound, warning light on the head-up display (if equipped) will blink and the steering wheel will vibrate.
- The system will operate when your vehicle speed is between 40–120 mph (60–200 km/h) and both lane markings of the driving lane are detected.
- Emergency braking will be assisted to help prevent collision with the vehicle in the blind spot area.

#### WARNING

- **Collision-Avoidance Assist will be canceled under the following circumstances:**
  - Your vehicle enters the next lane by a certain distance
  - Your vehicle is away from the collision risk
  - The steering wheel is sharply steered
  - The brake pedal is depressed
  - Forward Collision-Avoidance Assist is operating
- **After system operation or lane change, you must drive to the center of the lane. The system will not operate if the vehicle is not driven in the center of the lane.**



©IK070088L

### Collision-Avoidance Assist (while departing)

- To warn the driver of a collision, the warning light on the side view mirror will blink and a warning message will appear on the cluster. At the same time, an audible warning will sound, warning light on the head-up display (if equipped) will blink and the steering wheel will vibrate.
- The system will operate when your vehicle speed is below 2 mph (3 km/h) and the speed of the vehicle in the blind spot area is above 3 mph (5 km/h).
- Emergency braking will be assisted to help prevent collision with the vehicle in the blind spot area.



©IK070009L

- When the vehicle is stopped due to emergency braking, the 'Drive carefully' warning message will appear on the cluster.  
For your safety, the driver should depress the brake pedal immediately and check the surroundings.
- Brake control will end after the vehicle is stopped by emergency braking for approximately 2 seconds.

**WARNING**

Take the following precautions when using Blind-Spot Safety system:

- For your safety, change the Settings after parking the vehicle at a safe location.
- If any other system's warning message is displayed or audible warning is generated, Blind-Spot Safety system's warning message may not be displayed and audible warning may not be generated.
- You may not hear the warning sound of Blind-Spot Safety system if the surrounding is noisy.
- Blind-Spot Safety system may not operate if the driver applies the brake pedal to avoid collision.
- When Blind-Spot Safety system is operating, braking control by the system will automatically cancel when the driver excessively depresses the accelerator pedal or sharply steers the vehicle.
- During Blind-Spot Safety system operation, the vehicle may stop suddenly injuring passengers and shifting loose objects. Always have the seat belt on and keep loose objects secured.
- Even if there is a problem with Blind-Spot Safety system, the vehicle's basic braking performance will operate normally.
- Blind-Spot Safety system does not operate in all situations or cannot avoid all collisions.

- Blind-Spot Safety system may warn the driver late or may not warn the driver depending on the road and driving conditions.
- Driver should maintain control of the vehicle at all times. Do not depend on Blind-Spot Safety system. Maintain a safe braking distance, and if necessary, depress the brake pedal to reduce driving speed or to stop the vehicle.
- Never operate Blind-Spot Safety system on people, animal, objects, etc. It may cause serious injury or death.

**WARNING**

The brake control may not operate properly depending on the status of ESC (Electronic Stability Control).

There will only be a warning when:

- The ESC (Electronic Stability Control) warning light is on
- ESC (Electronic Stability Control) is engaged in a different function

## Blind-Spot Safety system Malfunction and Limitations

### Blind-Spot Safety system malfunction

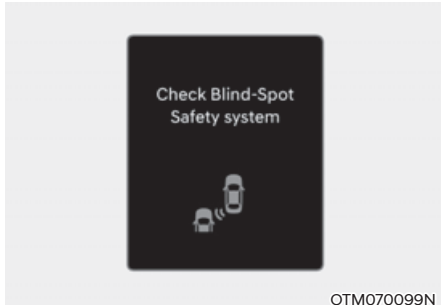

OTM070099N

When Blind-Spot Safety system is not working properly, the 'Check Blind-Spot Safety system' warning message will appear on the cluster, and the system will turn off automatically or the system will be limited. Have the vehicle inspected by an authorized retailer of Genesis Branded products.

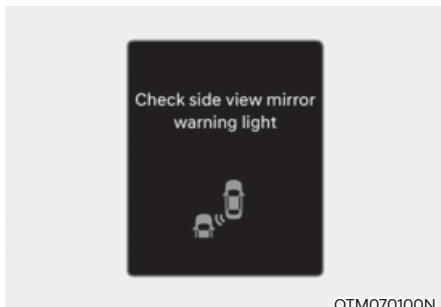

OTM070100N

When the side view mirror warning light is not working properly, the 'Check side view mirror warning light' warning message will appear on the cluster. Have the vehicle inspected by an authorized retailer of Genesis Branded products.

### Blind-Spot Safety system disabled

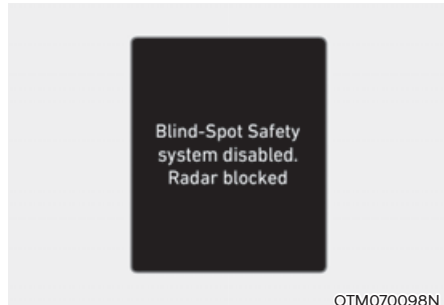

OTM070098N

When the rear bumper around the rear corner radar or sensor is covered with foreign material, such as snow or rain, or installing a trailer or carrier, it can reduce the detecting performance and temporarily limit or disable Blind-Spot Safety system.

If this occurs, the 'Blind-Spot Safety system disabled. Radar blocked' warning message will appear on the cluster.

The system will operate normally when such foreign material or trailer, etc. is removed, and then the engine is restarted.

If the system does not operate normally after it is removed, have the vehicle inspected by an authorized retailer of Genesis Branded products.

### **WARNING**

- Even though the warning message does not appear on the cluster, Blind-Spot Safety system may not properly operate.
- Blind-Spot Safety system may not properly operate in an area (e.g. open terrain) where any substance are not detected right after the engine is turned on, or when the detecting sensor is blocked with foreign material right after the engine is turned on.

**CAUTION**

**Turn off Blind-Spot Safety system to install a trailer, carrier, etc., or remove the trailer, carrier, etc. to use Blind-Spot Safety system.**

***Limitations of Blind- Spot Safety system***

Blind-Spot Safety system may not operate normally, or the system may operate unexpectedly under the following circumstances:

- There is inclement weather such as heavy snow, heavy rain, etc.
- The rear corner radar is covered with snow, rain, dirt, etc.
- The temperature around the rear corner radar is high or low
- Driving on a highway (or motorway) ramp
- The road pavement (or the peripheral ground) abnormally contains metallic components (i.e. possibly due to subway construction)
- There is a fixed object near the vehicle, such as sound barriers, guardrails, central dividers, entry barriers, street lamps, signs, tunnels, walls, etc. (including double structures)
- Driving in large areas where there are few vehicles or structures (i.e. desert, meadow, suburb, etc.)
- Driving through a narrow road where trees or grass are overgrown
- Driving on a wet road surface, such as a puddle on the road
- The other vehicle drives very close behind your vehicle, or the other vehicle passes by your vehicle in close proximity

- The speed of the other vehicle is very fast that it passes by your vehicle in a short time
- Your vehicle passes by the other vehicle
- Your vehicle changes lane
- Your vehicle has started at the same time as the vehicle next to you and has accelerated
- The vehicle in the next lane moves two lanes away from you, or when the vehicle two lanes away moves to the next lane from you
- A trailer or carrier is installed around the rear corner radar
- The bumper around the rear corner radar is covered with objects, such as a bumper sticker, bumper guard, bike rack, etc.
- The bumper around the rear corner radar is impacted, damaged or the radar is out of position
- Your vehicle height is low or high due to heavy loads, abnormal tire pressure, etc.

Blind-Spot Safety system may not operate normally, or the system may operate unexpectedly when the following objects are detected:

- A motorcycle or bicycle is detected
- A vehicle such as a flat trailer is detected
- A big vehicle such as a bus or truck is detected
- A moving obstacle such as a pedestrian, animal, shopping cart or a baby stroller is detected
- A vehicle with low height such as a sports car is detected

Braking control may not work, driver's attention is required in the following circumstances:

- The vehicle severely vibrates while driving over a bumpy road, uneven road or concrete patch
- Driving on a slippery surface due to snow, water puddle, ice, etc.
- The tire pressure is low or a tire is damaged
- The brake is reworked
- The vehicle makes abrupt lane changes

### **i** Information

For more details on the limitations of the front view camera, refer to “Forward Collision-Avoidance Assist (FCA)” and “Lane Keeping Assist (LKA)” section in chapter 7.

### **⚠** WARNING

- Driving on a curve



**Blind-Spot Safety system may not operate properly when driving on a curved road. The system may not detect the vehicle in the next lane.**

**Always pay attention to road and driving conditions while driving.**



**Blind-Spot Safety system may not operate properly when driving on a curved road. The system may recognize a vehicle in the same lane.**

**Always pay attention to road and driving conditions while driving.**

- Driving where the road is merging/dividing

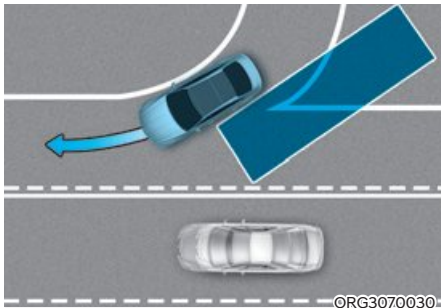

Blind-Spot Safety system may not operate properly when driving where the road merges or divides. The system may not detect the vehicle in the next lane.

Always pay attention to road and driving conditions while driving.

- Driving on a slope

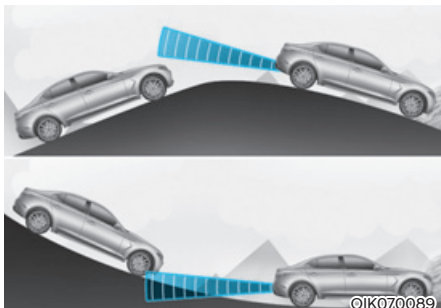

Blind-Spot Safety system may not operate properly when driving on a slope. The system may not detect the vehicle in the next lane or may incorrectly detect the ground or structure.

Always pay attention to road and driving conditions while driving.

- Driving where the heights of the lanes are different

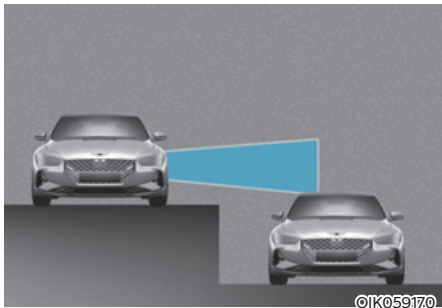

Blind-Spot Safety system may not operate properly when driving where the heights of the lanes are different. The system may not detect the vehicle on a road with different lane heights (underpass joining section, grade separated intersections, etc.).

Always pay attention to road and driving conditions while driving.

### WARNING

- If emergency towing is necessary, make sure that you turn off Blind-Spot Safety system.
- Blind-Spot Safety system may not operate normally if interfered by strong electromagnetic waves.
- Blind-Spot Safety system may not operate for 15 seconds after the vehicle is started, or the front view camera or rear corner radars are initialized.



## **i** Information

**This device complies with Part 15 of the FCC rules.**

**Operation is subject to the following three conditions:**

- 1. This device may not cause harmful interference, and**
- 2. This device must accept any interference received, including interference that may cause undesired operation.**
- 3. Changes or modifications not expressly approved by the party responsible for compliance could void the user's authority to operate the device.**

## **i** Information

**Radio frequency radiation exposure information:**

**This equipment complies with FCC radiation exposure limits set forth for an uncontrolled environment.**

**This equipment should be installed and operated with minimum distance of 8 in. (20 cm) between the radiator (antenna) and your body.**

**This transmitter must not be co-located or operating in conjunction with any other antenna or transmitter.**

## SAFE EXIT WARNING (SEW)

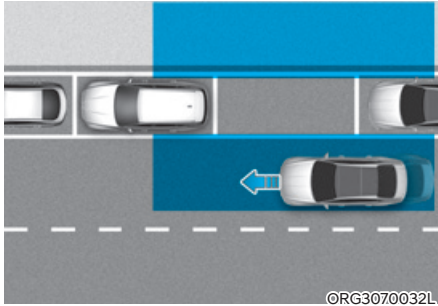

After the vehicle stops, when an approaching vehicle from the rear area is detected as soon as a passenger opens a door, Safe Exit Warning will warn the driver with a warning message and an audible warning to help prevent a collision.



### CAUTION

Warning timing may vary depending on the speed of the approaching vehicle.

## Detecting sensor

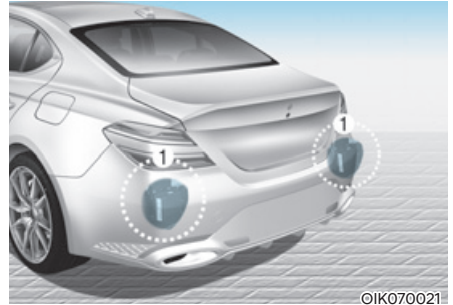

[1] : Rear corner radar

Refer to the picture above for the detailed location of the detecting sensors.



### CAUTION

For more details on the precautions of the rear corner radars, refer to “Blind-Spot Collision Warning (BCW)” section in chapter 7.

## Safe Exit Warning Settings

### Setting features

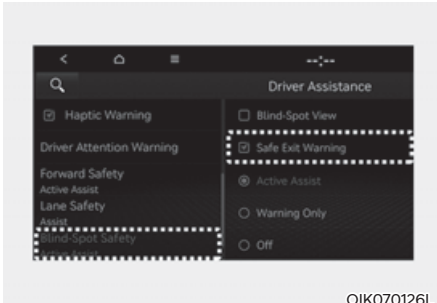

### Safe Exit Warning

With the engine on, select 'Driver Assistance → Blind-Spot Safety → Safe Exit Warning' from the Settings menu to turn on Safe Exit Warning and deselect to turn off the function.



### WARNING

The driver should always be aware of unexpected and sudden situations from occurring. If 'Safe Exit Warning' is deselected, Safe Exit Warning cannot assist you.



### Information

If the engine is restarted, Safe Exit Warning will maintain the last setting.

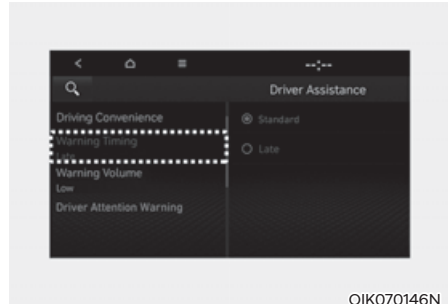

### Warning Timing

With the engine on, select 'Driver Assistance → Warning Timing' from the Settings menu to change the initial warning activation time for Safe Exit Warning.

When the vehicle is first delivered, Warning Timing is set to 'Standard'. If you change the Warning Timing, the warning time of other Driver Assistance systems may change.



OIK070147N

### Warning Volume

With the engine on, select 'Driver Assistance → Warning Volume' from the Settings menu to change the Warning Volume to 'High', 'Medium', 'Low' or 'Off' for Safe Exit Warning.

However, even if 'Off' is selected, the 'Standard' will not turn off but the volume will sound as 'Low'.

If you change the warning volume, the Warning Volume of other Driver Assistance systems may change.



### CAUTION

- **The setting of the Warning Timing and Warning Volume applies to all functions of the Safe Exit Warning.**
- **Even though 'Standard' is selected for Warning Timing, if the vehicle approaches at high speed from the rear, the initial warning activation time may seem late.**
- **Select 'Late' for Warning Timing when traffic is light and when driving speed is slow.**

## Safe Exit Warning Operation

### Safe Exit Warning warning

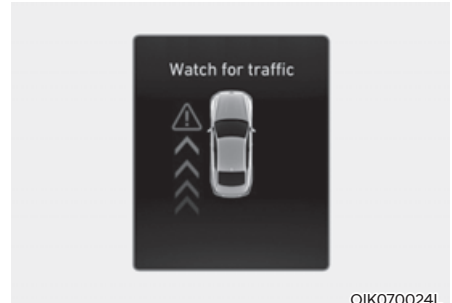

OIK070024L

### Collision warning when exiting vehicle

- When an approaching vehicle from the rear is detected at the moment a door is opened, the 'Watch for traffic' warning message will appear on the cluster, and an audible warning will sound.
- Safe Exit Warning will warn the driver when your vehicle speed is below 2 mph (3 km/h), and the speed of the approaching vehicle from the rear is above 3 mph (5 km/h).



## WARNING

Take the following precautions when using Safe Exit Warning:

- For your safety, change the Settings after parking the vehicle at a safe location.
- If any other system's warning message is displayed or audible warning is generated, Safe Exit Warning warning message may not be displayed and audible warning may not be generated.
- You may not hear the warning sound of Safe Exit Warning if the surrounding is noisy.
- Safe Exit Warning does not operate in all situations or cannot prevent all collisions.
- Safe Exit Warning may warn the driver late or may not warn the driver depending on the road and driving conditions. Always check vehicle surroundings.
- The driver and passengers are responsible for accidents that occurs while exiting the vehicle. Always check the surroundings before you exit the vehicle.
- Never deliberately operate Safe Exit Warning. Doing so may lead to serious injury or death.

- Safe Exit Warning does not operate if there is a problem with Blind-Spot Safety system. The warning message of Blind-Spot Safety system will appear when:
  - Blind-Spot Safety system sensor or the sensor surrounding is polluted or covered
  - Blind-Spot Safety system fails to warn passengers or falsely warn passengers



## Information

After the engine is turned off, Safe Exit Warning operates approximately for 3 minutes, but turns off immediately if the doors are locked.

## Safe Exit Warning Malfunction and Limitations

### Safe Exit Warning malfunction



When Safe Exit Warning is not working properly, the 'Check Blind-Spot Safety system' warning message will appear on the cluster for several seconds, and the master (⚠) warning light will illuminate on the cluster. If the master warning light illuminates, have the vehicle inspected by an authorized retailer of Genesis Branded products.

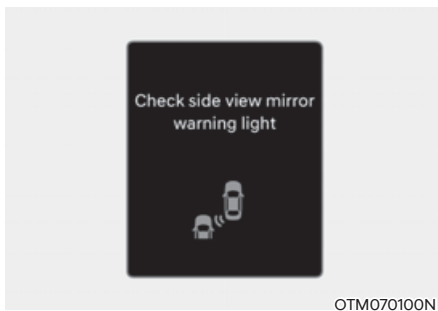

When the side view mirror warning light is not working properly, the 'Check side view mirror warning light' warning message will appear on the cluster for several seconds, and the master (⚠) warning light will illuminate on the cluster. If the master warning light illuminates, have the vehicle inspected by an authorized retailer of Genesis Branded products.

### Safe Exit Warning disabled

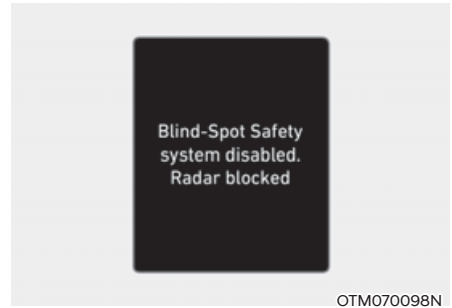

When the rear bumper around the rear corner radar or sensor is covered with foreign material, such as snow or rain, or installing a trailer or carrier, it can reduce the detecting performance and temporarily limit or disable Safe Exit Warning.

If this occurs, the 'Blind-Spot Safety system disabled. Radar blocked' warning message will appear on the cluster.

Safe Exit Warning will operate normally when such foreign material or trailer, etc. is removed, and then the engine is restarted.

If Safe Exit Warning does not operate normally after it is removed, have the vehicle inspected by an authorized retailer of Genesis Branded products.



## WARNING

- Even though the warning message does not appear on the cluster, Safe Exit Warning may not properly operate.
- Safe Exit Warning may not properly operate in an area (e.g. open terrain) where any substance are not detected right after the engine is turned on, or when the detecting sensor is blocked with foreign material right after the engine is turned on.



## CAUTION

Turn off Safe Exit Warning to install a trailer, carrier, etc., or remove the trailer, carrier, etc. to use Safe Exit Warning.

## *Limitations of Safe Exit Warning*

Safe Exit Warning may not operate normally, or it may operate unexpectedly under the following circumstances:

- Getting out of the vehicle where trees or grass are overgrown
- Getting out of the vehicle where the road is wet
- The approaching vehicle is very fast or very slow



## Information

For more details on the limitations of the rear corner radar, refer to “Blind-Spot Collision-Avoidance Assist (BCA)” section in this chapter.



## WARNING

- Safe Exit Warning may not operate normally if interfered by strong electromagnetic waves.
- Safe Exit Warning may not operate for 3 seconds after the vehicle is started, or the rear corner radars are initialized.

## DRIVER ATTENTION WARNING (DAW)

### Basic function

Driver Attention Warning will help determine the driver's attention level by analyzing driving pattern, driving time, etc. while vehicle is being driven. Driver Attention Warning will recommend a break when the driver's attention level falls below a certain level.

### Leading Vehicle Departure Alert function

Leading Vehicle Departure Alert function will inform the driver when the front vehicle departs from a stop.

### Detecting sensor

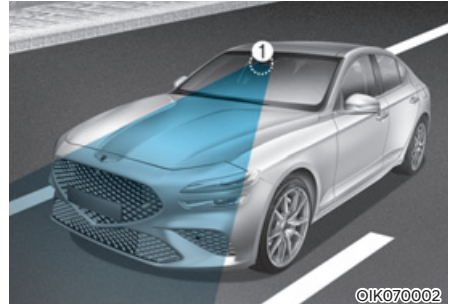

[1] : Front view camera

The front view camera is used to detect driving patterns and front vehicle departure while vehicle is being driven. Refer to the picture above for the detailed location of the detecting sensor.



### CAUTION

**Always keep the front view camera in good condition to maintain optimal performance of Driver Attention Warning.**

**For more details on the precautions of the front view camera, refer to “Forward Collision-Avoidance Assist (FCA)” section in chapter 7.**



## Driver Attention Warning Settings

### Setting features

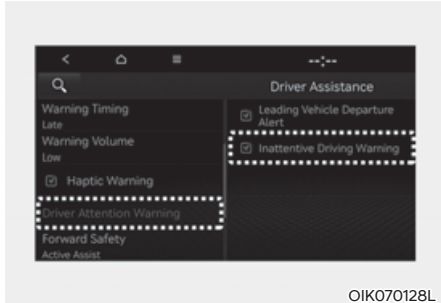

OIK070128L

### Driver Attention Warning

With the engine on, select or deselect 'Driver Assistance → Driver Attention Warning' from the Settings menu to set whether or not to use each function.

- If 'Inattentive Driving Warning' is selected, Driver Attention Warning will inform the driver the driver's attention level and will recommend taking a break when the level falls below a certain level.

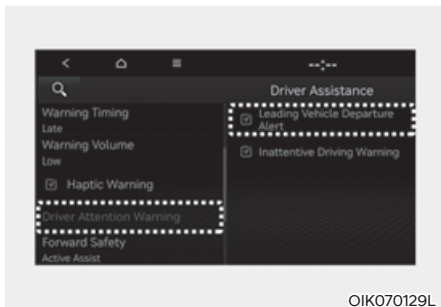

OIK070129L

### Leading Vehicle Departure Alert

- If 'Leading Vehicle Departure Alert' is selected, the function will inform the driver when the front vehicle departs from a stop.

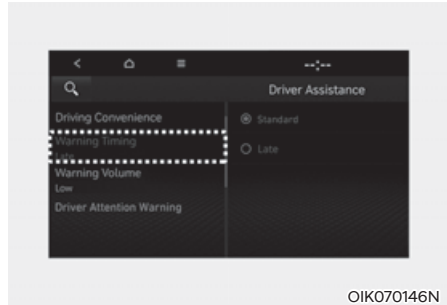

OIK070146N

### Warning Timing

With the engine on, select 'Driver Assistance → Warning Timing' from the Settings menu to change the initial warning activation time for Driver Attention Warning.

When the vehicle is first delivered, Warning Timing is set to 'Normal'. If you change the Warning Timing, the warning time of other Driver Assistance systems may change.

### Information

**If the engine is restarted, Driver Attention Warning will maintain the last setting.**

## Driver Attention Warning Operation

### Basic function

#### Display and warning

The basic function of Driver Attention Warning is to inform the driver of their 'Attention Level' and to warn the driver to 'Consider taking a break'.

- The driver's attention level is displayed on the scale of 1 to 5. The lower the level is, the more inattentive the driver is.
- The level decreases when the driver does not take a break for a certain period of time.

### Attention level

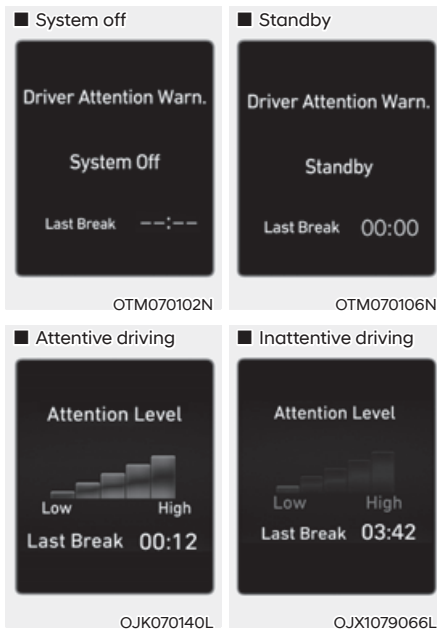

- The driver can monitor his/her driving conditions on the cluster.
  - When the 'Inattentive Driving Warning' is deselected from the Settings menu, 'System Off' is displayed.
  - Driver Attention Warning will operate when the vehicle speed is between 0~130 mph (0~210 km/h).
  - When the vehicle speed is not within the operating speed, the message 'Standby' will be displayed.

### Taking a break



- The 'Consider taking a break' message will appear on the cluster and an audible warning will sound to suggest that the driver take a break, when the driver's attention level is below 1.
- Driver Attention Warning will not suggest a break when the total driving time is shorter than 10 minutes or 10 minutes has not passed after the last break was suggested.



### WARNING

For your safety, change the Settings after parking the vehicle at a safe location.



### CAUTION

- Driver Attention Warning may suggest a break depending on the driver's driving pattern or habits, even if the driver doesn't feel fatigued.
- Driver Attention Warning is a supplemental function and may not be able to determine whether the driver is inattentive.
- The driver who feels fatigued should take a break at a safe location, even though there is no break suggestion by Driver Attention Warning.



### Information

- You may change settings from the infotainment system (Vehicle Settings), whichever option that is provided with your vehicle. For more details, see "Vehicle Settings" section in supplied Infotainment Manual.
- Driver Attention Warning will reset the last break time to 00:00 in the following situations:
  - The engine is turned off
  - The driver unfastens the seat belt and opens the driver's door
  - The vehicle is stopped for more than 10 minutes
- When the driver resets Driver Attention Warning, the last break time is set to 00:00 and the driver's attention level is set to High.

### **Leading Vehicle Departure Alert function**

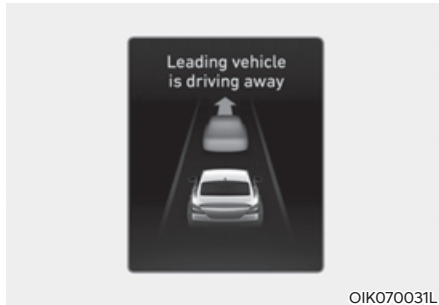

When a detected vehicle in front departs from a stop, Leading Vehicle Departure Alert will inform the driver by displaying the 'Leading vehicle is driving away' message on the cluster and an audible warning will sound.

#### **WARNING**

- If any other system's warning message is displayed or audible warning is generated, Driver Attention Warning message may not be displayed and audible warning may not be generated.
- The driver should hold the responsibility to safely drive and control the vehicle.

#### **CAUTION**

- Leading Vehicle Departure Alert is a supplemental function and may not alert the driver whenever the front vehicle departs from a stop.
- Always check the front of the vehicle and road conditions before departure.

### **Driver Attention Warning Malfunction and Limitations**

#### **Driver Attention Warning malfunction**

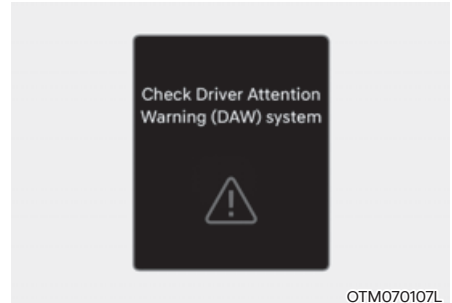

When Driver Attention Warning is not working properly, the 'Check Driver Attention Warning (DAW) system' warning message will appear on the cluster. If this occurs, have the vehicle inspected by an authorized retailer of Genesis Branded products.

#### **Limitations of Driver Attention Warning**

Driver Attention Warning may not work properly in the following situations:

- The vehicle is driven violently
- The vehicle intentionally crosses over lanes frequently
- The vehicle is controlled by Driver Assistance system, such as Lane Keeping Assist

### Leading Vehicle Departure Alert function

- When the vehicle cuts in

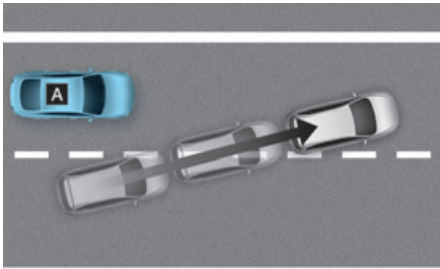

©ADAS040SD

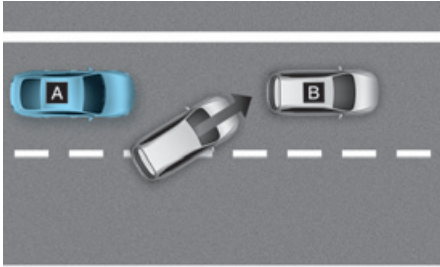

©ADAS054SD

[A] : Your vehicle, [B] : Front vehicle

If a vehicle cuts in front of your vehicle, Leading Departure Alert may not operate properly.

- When the vehicle ahead sharply steers

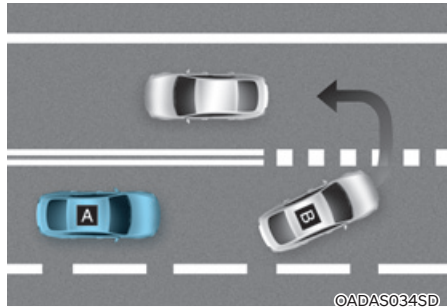

©ADAS034SD

[A] : Your vehicle, [B] : Front vehicle

If the vehicle in front makes a sharp turn, such as to turn left or right or make a U-turn, etc., Leading Vehicle Departure Alert may not operate properly.

- When the vehicle ahead abruptly departs

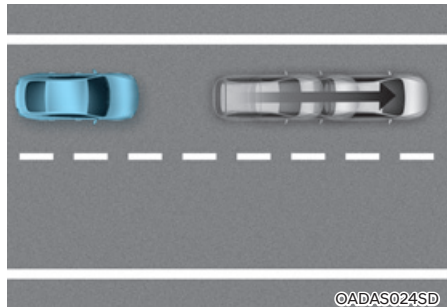

©ADAS024SD

If the vehicle in front abruptly departs, Leading Vehicle Departure Alert may not operate properly.

- When a pedestrian or bicycle is between your vehicle and the vehicle ahead



If there is a pedestrian(s) or bicycle(s) in between your vehicle and the vehicle in front, Leading Vehicle Departure Alert may not operate properly.

- When in a parking lot

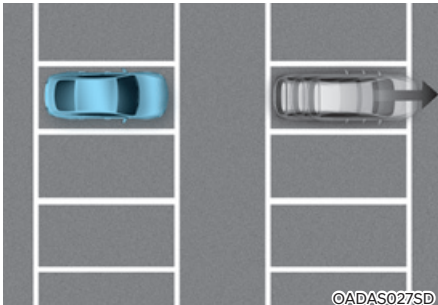

If a vehicle parked in front drives away from you, Leading Vehicle Departure Alert may alert you that the parked vehicle is driving away.

- When driving at a tollgate or intersection, etc.

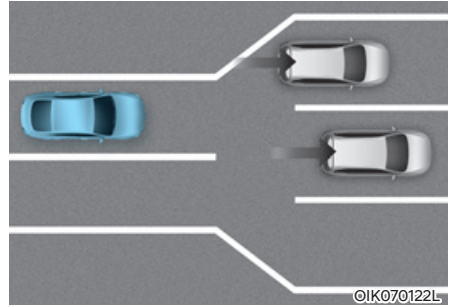

If you pass a tollgate or intersection with lots of vehicles or you drive where lanes are merged or divided frequently, Leading Vehicle Departure Alert may not operate properly.

### **i** Information

For more details on the precautions of the front view camera, refer to “Forward Collision-Avoidance Assist (FCA)” section in chapter 7.

## BLIND-SPOT VIEW MONITOR (BVM) (IF EQUIPPED)

■ Left side

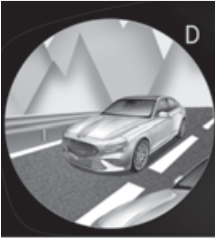

OIK070150N

■ Right side



OIK070151N

Blind-Spot View Monitor displays the rear blind spot area of the vehicle in the cluster when the turn signal is turned on to help change lanes.

### Detecting sensor



OIK070034

[1], [2] : SVM-side view camera

(camera located at bottom of the mirror)

Refer to the picture above for the detailed location of the detecting sensors.

## Blind-Spot View Monitor Settings

### Setting features

#### Blind-Spot View

With the engine on, select 'Driver Assistance → Blind-Spot Safety → Blind-Spot View' from the Settings menu to turn on Blind-Spot View Monitor and deselect to turn off the function.

## Blind-Spot View Monitor Operation

### Operating switch

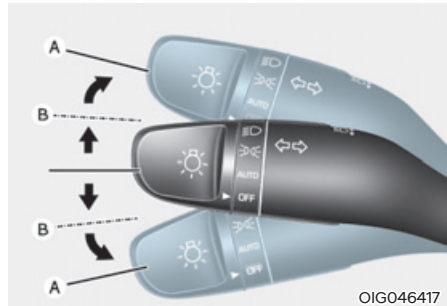

OIG046417

#### Turn signal switch

Blind-Spot View Monitor will turn on and off when the turn signal is turned on and off.

## **Blind-Spot View Monitor**

### **Operating conditions**

When the left or right side turn signal turns on, the image in that direction is displayed on the instrument cluster.

### **Off conditions**

- When the turn signal turns off, the image on the instrument cluster will turn off.
- When the hazard warning flasher is on, Blind-Spot View Monitor will turn off, regardless of the turn signal status.
- When other important warning is displayed on the instrument cluster, Blind-Spot View Monitor may turn off.

## **Blind-Spot View Monitor Malfunction**

When Blind-Spot View Monitor is not working properly, or the cluster display flickers, or the camera image does not display normally, have the vehicle inspected by an authorized retailer of Genesis Branded products.



### **WARNING**

- **The image shown on the cluster may differ from the actual distance of the object. Make sure to directly check the vehicle's surroundings for safety.**
- **Always keep the camera lens clean. If the lens is covered with foreign material, it may adversely affect camera performance and Blind-Spot View Monitor may not operate normally.**



## SMART CRUISE CONTROL (SCC)

Smart Cruise Control is designed to detect the vehicle ahead and help maintain the desired speed and minimum distance between the vehicle ahead.

### Overtaking Acceleration Assist

While Smart Cruise Control is operating, if the function judges that the driver is determined to overtake the vehicle in front, acceleration will be assisted.

### Detecting sensor

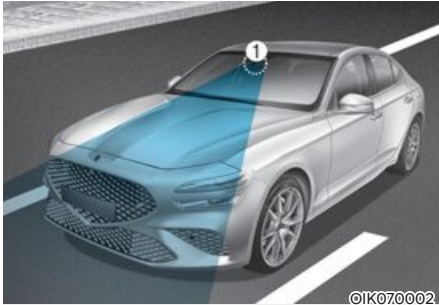

[1] : Front view camera,

[2] : Front radar

The front view camera and front radar are used as a detecting sensor to help detect the vehicles in front.

Refer to the picture above for the detailed location of the detecting sensor.



### CAUTION

**Always keep the front view camera and front radar in good condition to maintain optimal performance of Smart Cruise Control.**

**For more details on the precautions of the front view camera and front radar, refer to “Forward Collision-Avoidance Assist (FCA)” section in chapter 7.**

## Smart Cruise Control Settings

### Setting features

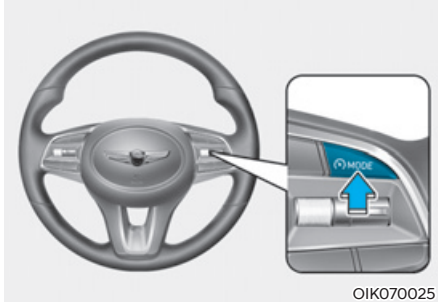

#### To turn on Smart Cruise Control

- Press the Driving Assist button to turn on Smart Cruise Control. The speed will be set to the current speed on the cluster.
- If there is no vehicle in front of you, the set speed will be maintained, but if there is a vehicle in front of you, the speed may decrease to maintain the distance to the vehicle ahead. If the vehicle ahead accelerates, your vehicle will travel at a steady cruising speed after accelerating to the set speed.

#### **i** Information

- If your vehicle speed is between 0~20 mph (0~30 km/h) when you press the Driving Assist button, the Smart Cruise Control speed will be set to 20 mph (30 km/h).
- The Driving Assist button symbol may vary depending on your vehicle option.

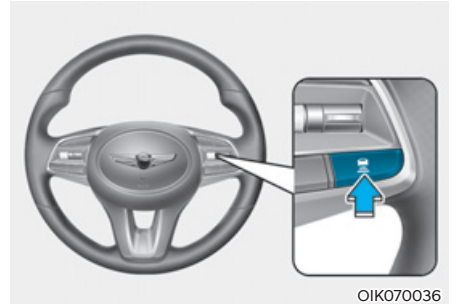

#### To set vehicle distance

Each time the button is pressed, the vehicle distance changes as follows:

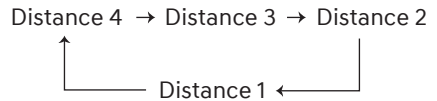

#### **i** Information

- If you drive at 56 mph (90 km/h), the distance is maintained as follows:
  - Distance 4 - approximately 172 ft. (52.5 m)
  - Distance 3 - approximately 130 ft. (40 m)
  - Distance 2 - approximately 106 ft. (32.5 m)
  - Distance 1 - approximately 82 ft. (25 m)
- The distance is set to the last set distance when the engine is restarted, or when Smart Cruise Control was temporarily canceled.

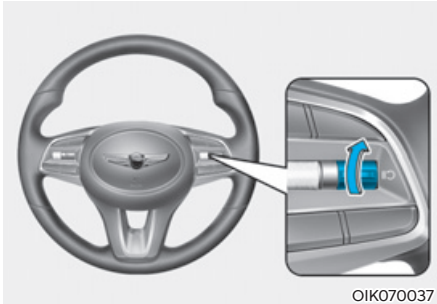

### To increase speed

- Push the + switch up and release it immediately. The cruising speed will increase by 1 mph (1 km/h) each time the switch is operated in this manner.
- Push the + switch up and hold it while monitoring the set speed on the cluster. The cruising speed will increase by 5 mph each time the switch is operated in this manner. Release the switch when the desired speed is shown, and the vehicle will accelerate to that speed. You can set the speed to 120 mph (200 km/h).

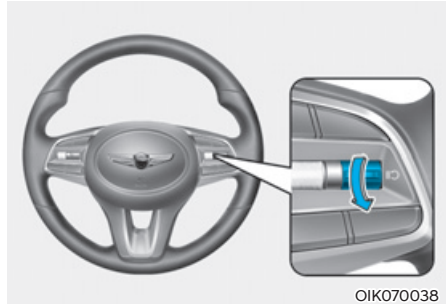

### To decrease speed

- Push the - switch down and release it immediately. The cruising speed will decrease by 1 mph (1 km/h) each time the switch is operated in this manner.
- Push the - switch down and hold it while monitoring the set speed on the cluster. The cruising speed will decrease by 5 mph each time the switch is operated in this manner. Release the switch at the speed you want to maintain. You can set the speed to 20 mph (30 km/h).



## WARNING

**Check the driving condition before using the + switch. Driving speed may sharply increase when you push up and hold the + switch.**

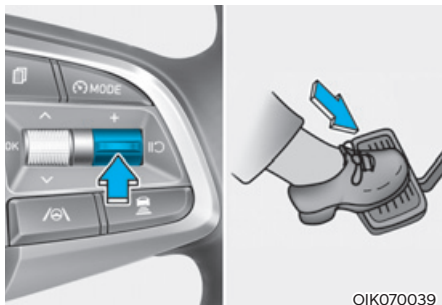

OIK070039

### To temporarily cancel Smart Cruise Control

Press the **||** switch or depress the brake pedal to temporarily cancel Smart Cruise Control.

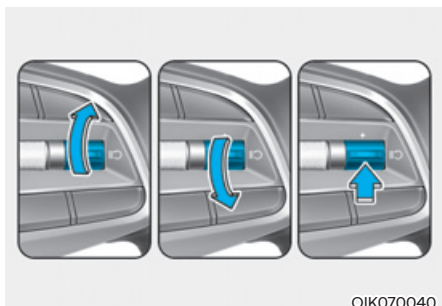

OIK070040

### To resume Smart Cruise Control

To resume Smart Cruise Control after the function was canceled, push the +, - or **||** switch.

If you push the + switch up or - switch down, vehicle speed will be set to the current speed on the cluster.

If you push the **||** switch, vehicle speed will resume to the preset speed.

### **!** WARNING

Check the driving condition before using the **||** switch. Driving speed may sharply increase or decrease when you press the **||** switch.

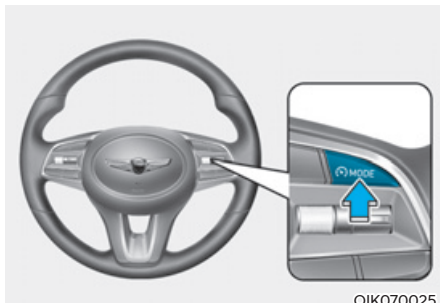

OIK070025

### To turn off Smart Cruise Control

Press the Driving Assist button to turn Smart Cruise Control off.

### **i** Information

If your vehicle is equipped with Manual Speed Limit Assist, press and hold the Driving Assist button to turn off Smart Cruise Control. However, Manual Speed Limit Assist will turn on.

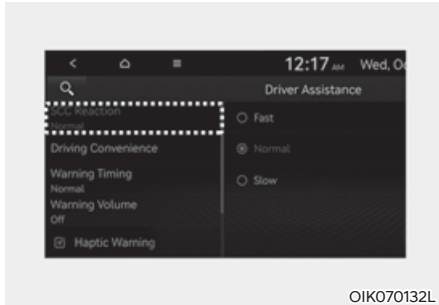

OIK070132L

### Smart Cruise Control Reaction

With the engine on, select 'Driver Assistance → SCC Reaction' from the settings menu to select the sensitivity of vehicle speed when following the front vehicle to maintain the set distance.

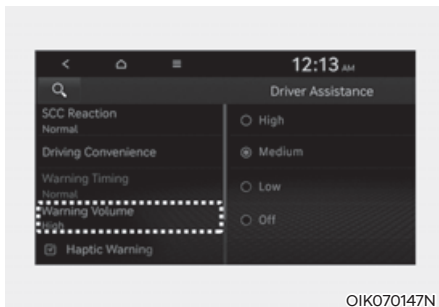

OIK070147N

### Warning Volume

With the engine on, select 'Driver Assistance → Warning Volume' from the Settings menu to change the Warning Volume 'High', 'Medium', 'Low' or 'Off' for Smart Cruise Control.

However, even if 'Off' is selected, the system's Warning Volume will not turn off but the volume will sound as 'Low'.

If you change the Warning Volume, the Warning Volume of other Driver Assistance systems may change.

### **i** Information

**If the engine is restarted, Warning Volume will maintain the last setting.**

## Smart Cruise Control Operation

### Operating conditions

Smart Cruise Control will operate when the following conditions are satisfied.

#### Basic function

- The gear is in D (Drive)
- The driver's door is closed
- EPB (Electronic Parking Brake) is not applied
- Your vehicle speed is within the operating speed range
  - 5~120 mph (10~200 km/h): when there is no vehicle in front
  - 0~120 mph (0~200 km/h): when there is a vehicle in front
- ESC (Electronic Stability Control) or TCS (Traction Control System) or ABS is on
- ESC (Electronic Stability Control) or TCS (Traction Control System) or ABS is not controlling the vehicle
- Engine RPM is not in the red zone
- Forward Collision-Avoidance Assist brake control is not operating

### **i** Information

**At a stop, if there is no vehicle in front of your vehicle, Smart Cruise Control will turn on when the brake pedal is depressed.**

### Overtaking Acceleration Assist

Overtaking Acceleration Assist will operate when the turn signal indicator is turned on to the left (left-hand drive) or turned on to the right (right-hand drive) while Smart Cruise Control is operating, and the following conditions are satisfied:

- Your vehicle speed is above 40 mph (60 km/h)
- The hazard warning flasher is off
- A vehicle is detected in front of your vehicle
- Deceleration is not needed to maintain distance with the vehicle in front



### WARNING

- **When the turn signal indicator is turned on to the left (left-hand drive) or turned on to the right (right-hand drive) while there is a vehicle ahead, the vehicle may accelerate temporarily. Pay attention to the road conditions at all times.**
- **Regardless of your countries driving direction, Overtaking Acceleration Assist will operate when the conditions are satisfied. When using the function in countries with different driving direction, always check the road conditions at all times.**

### Smart Cruise Control Display and Control

#### Basic function

You can see the status of the Smart Cruise Control operation in the Driving Assist mode on the cluster. Refer to “LCD Display Modes” section in chapter 4.

Smart Cruise Control will be displayed as below depending on the status of the function.



- When operating
  - (1) Whether there is a vehicle ahead and the selected distance level are displayed.
  - (2) Set speed is displayed.
  - (3) Whether there is a vehicle ahead and the target vehicle distance are displayed.

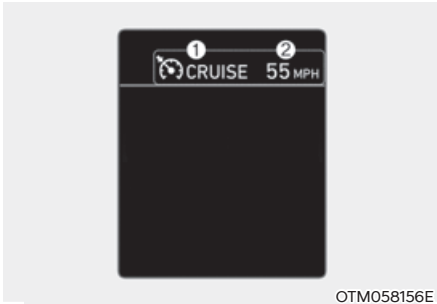

OTM058156E

- When temporarily canceled  
(1) CRUISE indicator is displayed.  
(2) The previous set speed is shaded.

### Information

- The distance of the front vehicle on the cluster is displayed according to the actual distance between your vehicle and the vehicle ahead.
- The target distance may vary according to the vehicle speed and the set distance level. If the vehicle speed is low, even though the vehicle distance have changed, the change of the target vehicle distance may be small.

### To temporarily accelerate



OIK070045N

If you want to speed up temporarily without altering the set speed while Smart Cruise Control is operating, depress the accelerator pedal. While the accelerator pedal is depressed, the set speed, distance level and target distance will blink on the cluster.

However, if the accelerator pedal is depressed insufficiently, the vehicle may decelerate.

### WARNING

**Be careful when accelerating temporarily, because the speed and distance is not controlled automatically even if there is a vehicle in front of you.**

### Smart Cruise Control temporarily canceled

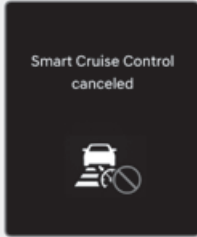

OTM070113N

Smart Cruise Control will be temporarily canceled automatically when:

- The vehicle speed is above 130 mph (210 km/h)
- The vehicle is stopped for a certain period of time
- The accelerator pedal is continuously depressed for a certain period of time
- The conditions for the Smart Cruise Control to operate is not satisfied

If Smart Cruise Control is temporarily canceled automatically, the 'Smart Cruise Control canceled' warning message will appear on the cluster, and an audible warning will sound to warn the driver.

If Smart Cruise Control is temporarily canceled while the vehicle is at a standstill with the function activated, EPB (Electronic Parking Brake) maybe applied.

### WARNING

When Smart Cruise Control is temporarily canceled, distance with the front vehicle will not be maintained. Always have your eyes on the road while driving, and if necessary, depress the brake pedal to reduce your driving speed in order to maintain a safe distance.

### Smart Cruise Control conditions not satisfied

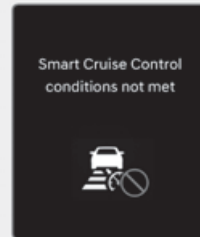

OTM070114L

If the Driving Assist button, + switch, - switch or  switch is pushed when Smart Cruise Control operating conditions are not satisfied, the 'Smart Cruise Control conditions not met' will appear on the cluster, and an audible warning will sound.



### ***In traffic situation***



In traffic, your vehicle will stop if the vehicle ahead of you stops. Also, if the vehicle ahead of you starts moving, your vehicle will start as well. In addition, after the vehicle has stopped and a certain time have passed, the 'Use switch or pedal to accelerate' message will appear on the cluster. Depress the accelerator pedal or push the + switch, - switch or  switch to start driving.

#### **WARNING**

**While the message is displayed on the cluster, if there is no vehicle in front or the vehicle is far away from you, and the + switch, - switch or  switch is pushed, Smart Cruise Control will automatically cancel and EPB will be applied. However, if the accelerator pedal is depressed, EPB will not be applied even though the system is canceled. Always pay attention to the road condition ahead.**

### ***Warning road conditions ahead***



In the following situation, the 'Watch for surrounding vehicles' warning message will appear on the cluster, and an audible warning will sound to warn the driver of road conditions ahead.

- The vehicle in front disappears when Smart Cruise Control is maintaining the distance with the vehicle ahead while driving below a certain speed.
- While the 'Use switch or pedal to accelerate' message is displayed on the cluster, if there is no vehicle in front or the vehicle is far away from you, and the + switch, - switch or  switch is pushed.

#### **WARNING**

**Always pay attention to vehicles or objects that may suddenly appear in front of you, and if necessary, depress the brake pedal to reduce your driving speed in order to maintain a safe distance.**

## Collision Warning

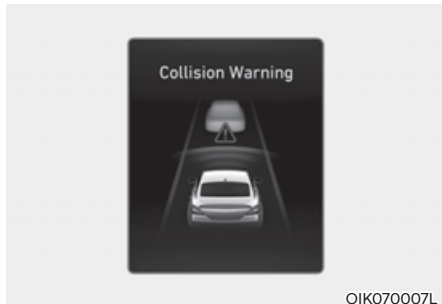

While Smart Cruise Control is operating, when the collision risk with the vehicle ahead is high, the 'Collision Warning' warning message will appear on the cluster, and an audible warning will sound to warn the driver. Always have your eyes on the road while driving, and if necessary, depress the brake pedal to reduce your driving speed in order to maintain a safe distance.

### **WARNING**

In the following situations, Smart Cruise Control may not warn the driver of a collision.

- The distance from the front vehicle is near, or the vehicle speed of the front vehicle is faster or similar with your vehicle
- The speed of the front vehicle is very slow or is at a standstill
- The accelerator pedal is depressed right after Smart Cruise Control is turned on

### **WARNING**

Take the following precautions when using Smart Cruise Control:

- Smart Cruise Control does not substitute for proper and safe driving. It is the responsibility of the driver to always check the speed and distance to the vehicle ahead.
- Smart Cruise Control may not recognize unexpected and sudden situations or complex driving situations, so always pay attention to driving conditions and control your vehicle speed.
- Keep Smart Cruise Control off when the function is not in use to avoid inadvertently setting a speed.
- Do not open the door or leave the vehicle when Smart Cruise Control is operating, even if the vehicle is stopped.
- Always be aware of the selected speed and vehicle distance.
- Keep a safe distance according to road conditions and vehicle speed. If the vehicle distance is too close during high-speed driving, a serious collision may result.
- When maintaining distance with the vehicle ahead, if the front vehicle disappears, Smart Cruise Control may suddenly accelerate to the set speed. Always be aware of unexpected and sudden situations from occurring.
- The vehicle speed may decrease on an upward slope and increase on a downward slope.
- Always be aware of situations such as when a vehicle cuts in suddenly.

- If emergency towing is necessary, we recommend that Smart Cruise Control is turned off due to safety reasons.
- Turn off Smart Cruise Control when your vehicle is being towed.
- Smart Cruise Control may not operate normally if interfered by strong electromagnetic waves.
- Smart Cruise Control may not detect an obstacle in front and lead to a collision. Always look ahead cautiously to prevent unexpected and sudden situations from occurring.
- Vehicles moving in front of you with a frequent lane change may cause a delay in Smart Cruise Control reaction or may cause Smart Cruise Control to react to a vehicle actually in an adjacent lane. Always drive cautiously to prevent unexpected and sudden situations from occurring.
- Always be aware of the surroundings and drive safely, even though a warning message does not appear or an audible warning does not sound.
- If any other system's warning message is displayed or warning sound is generated, Smart Cruise Control warning message may not be displayed and warning sound may not be generated.
- You may not hear the warning sound of Forward Collision-Avoidance Assist if the surrounding is noisy.
- The vehicle manufacturer is not responsible for any traffic violation or accidents caused by the driver.
- Always set the vehicle speed to the speed limit in your country.

## **i** Information

- Smart Cruise Control may not operate for a few seconds after the vehicle is started or the front view camera or front radar is initialized.
- You may hear a sound when the brake is controlled by Smart Cruise Control.

## Smart Cruise Control Malfunction and Limitations

### *Smart Cruise Control malfunction*

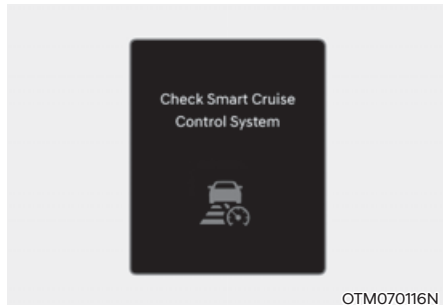

OTM070116N

When Smart Cruise Control is not working properly, the 'Check Smart Cruise Control system' warning message will appear, and the  warning light will illuminate on the cluster. Have the vehicle inspected by an authorized retailer of Genesis Branded products.

### Smart Cruise Control disabled

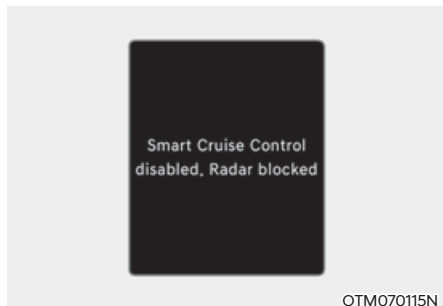

When the front radar cover or sensor is covered with snow, rain, or foreign material, it can reduce the detecting performance and temporarily limit or disable Smart Cruise Control.

If this occurs the 'Smart Cruise Control disabled. Radar blocked' warning message will appear for a certain period of time on the cluster.

Smart Cruise Control will operate normally when snow, rain or foreign material is removed.



#### WARNING

**Even though the warning message does not appear on the cluster, Smart Cruise Control may not properly operate.**



#### CAUTION

**Smart Cruise Control may not properly operate in an area (e.g. open terrain), where there is nothing to detect after turning ON the engine.**

### Limitations of Smart Cruise Control

Smart Cruise Control may not operate normally, or it may operate unexpectedly under the following circumstances:

- The detecting sensor or the surroundings are contaminated or damaged
- Washer fluid is continuously sprayed, or the wiper is on
- The camera lens is contaminated due to tinted, filmed or coated windshield, damaged glass, or stuck of foreign material (sticker, bug, etc.) on the glass
- Moisture is not removed or frozen on the windshield
- The field of view of the front view camera is obstructed by sun glare
- Street light or light from an oncoming vehicle is reflected on the wet road surface, such as a puddle on the road
- The temperature around the front view camera is high or low
- An object is placed on the dashboard
- The surrounding is very bright
- The surrounding is very dark, such as in a tunnel, etc.
- The brightness changes suddenly, for example when entering or exiting a tunnel
- The brightness outside is low, and the headlamps are not on or are not bright
- Driving in heavy rain or snow, or thick fog
- Driving through steam, smoke or shadow

- Only part of the vehicle is detected
- The vehicle in front has no tail lights, tail lights are located unusually, etc.
- The brightness outside is low, and the tail lamps are not on or are not bright
- The rear of the front vehicle is small or does not look normal (i.e. tilted, overturned, etc.)
- The front vehicle's ground clearance is low or high
- A vehicle suddenly cuts in front
- Your vehicle is being towed
- Driving through a tunnel or iron bridge
- Driving near areas containing metal substances, such as a construction zone, railroad, etc.
- A material is near that reflects very well on the front radar, such as a guardrail, nearby vehicle, etc.
- The bumper around the front radar is impacted, damaged or the front radar is out of position
- The temperature around the front radar is high or low
- Driving in large areas where there are few vehicles or structures (i.e. desert, meadow, suburb, etc.)
- The vehicle in front is made of material that does not reflect on the front radar
- Driving near a highway (or motorway) interchange or tollgate
- Driving on a slippery surface due to snow, water puddle, ice, etc.
- Driving on a curved road
- The vehicle in front is detected late
- The vehicle in front is suddenly blocked by an obstacle
- The vehicle in front suddenly changes lane or suddenly reduces speed
- The vehicle in front is bent out of shape
- The front vehicle's speed is fast or slow
- With a vehicle in front, your vehicle changes lane at low speed
- The vehicle in front is covered with snow
- Unstable driving
- You are on a roundabout and the vehicle in front is not detected
- You are continuously driving in a circle
- Driving in a parking lot
- Driving through a construction area, unpaved road, partially paved road, uneven road, speed bumps, etc.
- Driving on an incline road, curved road, etc.
- Driving through a roadside with trees or streetlights
- The adverse road conditions cause excessive vehicle vibrations while driving
- Your vehicle height is low or high due to heavy loads, abnormal tire pressure, etc.
- Driving through a narrow road where trees or grass are overgrown
- There is interference by electromagnetic waves, such as driving in an area with strong radio waves or electrical noise

- Driving on a curve

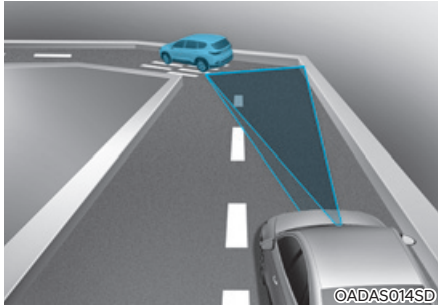

On curves, Smart Cruise Control may not detect a vehicle in the same lane, and may accelerate to the set speed. Also, vehicle speed may rapidly decrease when the vehicle ahead is detected suddenly.

Select the appropriate set speed on curves and apply the brake pedal or accelerator pedal according to the road and driving conditions ahead.

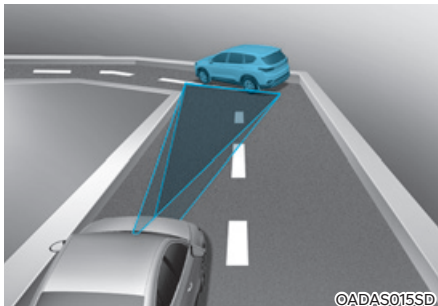

Your vehicle speed can be reduced due to a vehicle in the adjacent lane.

Apply the accelerator pedal and select the appropriate set speed. Check to be sure that the road conditions permit safe operation of the Smart Cruise Control.

- Driving on a slope

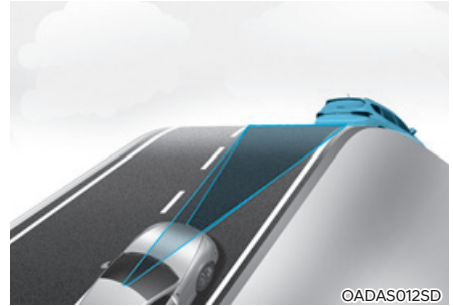

During uphill or downhill driving, the Smart Cruise Control may not detect a moving vehicle in your lane, and cause your vehicle to accelerate to the set speed. Also, vehicle speed will rapidly decrease when the vehicle ahead is detected suddenly.

Select the appropriate set speed on inclines and apply the brake pedal or accelerator pedal according to the road and driving conditions ahead.

- Changing lanes

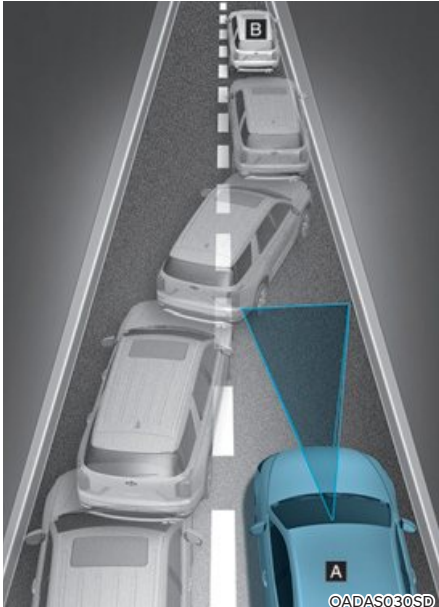

[A] : Your vehicle, [B] : Lane changing vehicle

When a vehicle moves into your lane from an adjacent lane, it cannot be detected by the sensor until it is in the sensor's detection range. Smart Cruise Control may not immediately detect the vehicle when the vehicle changes lanes abruptly. In this case, you must maintain a safe braking distance, and if necessary, depress the brake pedal to reduce your driving speed in order to maintain a safe distance.

- Detecting vehicle

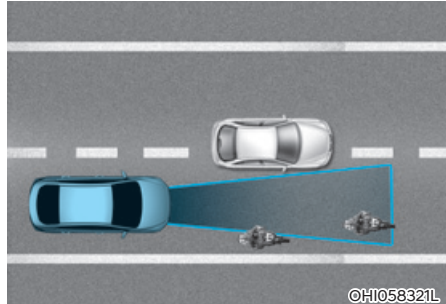

In the following cases, some vehicles in your lane cannot be detected by the sensor:

- Vehicles offset to one side
- Slow-moving vehicles or sudden-decelerating vehicles
- Oncoming vehicles
- Stopped vehicles
- Vehicles with small rear profile, such as trailers
- Narrow vehicles, such as motorcycles or bicycles
- Special vehicles
- Animals and pedestrians

Adjust your vehicle speed by depressing the brake pedal according to the road and driving conditions ahead.

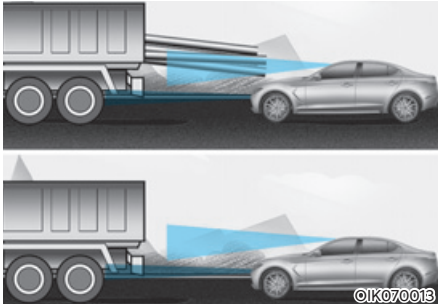

In the following cases, the vehicle in front cannot be detected by the sensor:

- Vehicles with higher ground clearance or vehicles carrying loads that stick out of the back of the vehicle
- Vehicles that has the front lifted due to heavy loads
- You are steering your vehicle
- Driving on narrow or sharply curved roads

Adjust your vehicle speed by depressing the brake pedal according to the road and driving conditions ahead.

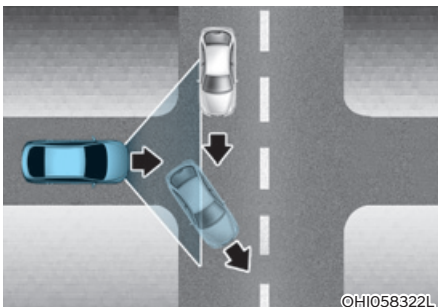

- When a vehicle ahead disappears at an intersection, your vehicle may accelerate.

Always pay attention to road and driving conditions while driving.

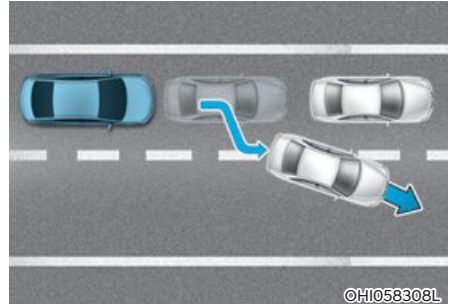

- When a vehicle in front of you merges out of the lane, Smart Cruise Control may not immediately detect the new vehicle that is now in front of you. Always pay attention to road and driving conditions while driving.

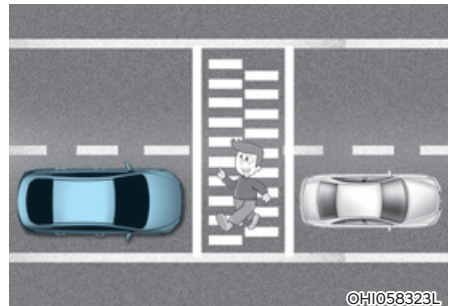

- Always look out for pedestrians when your vehicle is maintaining a distance with the vehicle ahead.



## **i** Information

**This device complies with Part 15 of the FCC rules.**

**Operation is subject to the following three conditions:**

- 1. This device may not cause harmful interference, and**
- 2. This device must accept any interference received, including interference that may cause undesired operation.**
- 3. Changes or modifications not expressly approved by the party responsible for compliance could void the user's authority to operate the device.**

## **i** Information

**Radio frequency radiation exposure information:**

**This equipment complies with FCC radiation exposure limits set forth for an uncontrolled environment.**

**This equipment should be installed and operated with minimum distance of 8 in. (20 cm) between the radiator (antenna) and your body.**

**This transmitter must not be co-located or operating in conjunction with any other antenna or transmitter.**

## NAVIGATION-BASED SMART CRUISE CONTROL (NSCC) (IF EQUIPPED)

Navigation-based Smart Cruise Control will help drive at a safe speed according to the road conditions when driving on highways by using road information from the navigation system while Smart Cruise Control is operating.

### **i** Information

- **Navigation-based Smart Cruise Control is available only on controlled access road of certain highways.**
  - \* **Controlled access road indicates roads with limited entrances and exits that allow uninterrupted high speed traffic flow. Only passenger cars and motorcycles are allowed on controlled access roads.**
- **Additional highways may be expanded by future navigation updates.**

### **i** Information

Navigation-based Smart Cruise Control operates on main roads of highways and does not operate on interchanges or junctions.

#### Highway Curve Zone Auto Slowdown

If the vehicle speed is high, Highway Curve Zone Auto Slowdown function will temporarily decelerate your vehicle or limit acceleration to help you drive on a curve based on the curve information from the navigation.

#### Highway Set Speed Auto Change

Highway Set Speed Auto Change function automatically changes Smart Cruise Control set speed based on the speed limit information from the navigation.

## Navigation-based Smart Cruise Control Settings

### Setting features

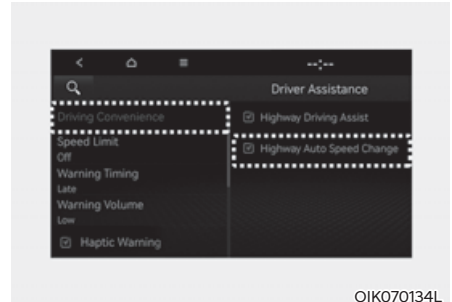

OIK070134L

With the engine on, select 'Driver Assistance → Driving Convenience → Highway Auto Speed Change' from the Settings menu to turn on Navigation-based Smart Cruise Control and deselect to turn off the function.

### **i** Information

**When there is a problem with Navigation-based Smart Cruise Control, the function cannot be set from the Settings menu.**

## Navigation-based Smart Cruise Control Operation

### Operating conditions

Navigation-based Smart Cruise Control is ready to operate if all of the following conditions are satisfied:

- Smart Cruise Control is operating
- Driving on main roads or highways

### **i** Information

For more details on how to operate Smart Cruise Control, refer to “Smart Cruise Control (SCC)” section in chapter 7.

### Navigation-based Smart Cruise Control display and control

When Navigation-based Smart Cruise Control operates, it will be displayed on the cluster as follows:

- Navigation-based Smart Cruise Control standby

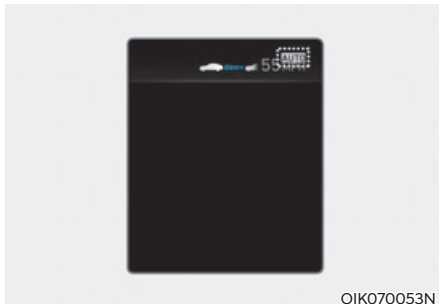

If the operating conditions are satisfied, the white **AUTO** indicator will illuminate.

- Navigation-based Smart Cruise Control operating



If temporary deceleration is required in the standby state and Navigation-based Smart Cruise Control is operating, the green **AUTO** symbol will illuminate on the cluster.

If the Highway Set Speed Auto Change function operates, the **AUTO** symbol and set speed will illuminate in green on the cluster, and an audible warning will sound.

### **!** WARNING



‘The Drive carefully’ warning message will appear in the following circumstances:

- Navigation-based Smart Cruise Control is not able to slow down your vehicle to a safe speed

## **i** Information



**Highway Curve Zone Auto Slowdown and Highway Set Speed Auto Change function uses the same **AUTO** symbol.**

### **Highway Curve Zone Auto Slowdown**

- Depending on the curve ahead on the highway, the vehicle will decelerate, and after passing the curve, the vehicle will accelerate to Smart Cruise Control set speed.
- Vehicle deceleration time may differ depending on the vehicle speed and the degree of the curve on the road. The higher the driving speed, deceleration will start faster.

### **Highway Set Speed Auto Change**

- Highway Set Speed Auto Change function will operate when Smart Cruise Control set speed and the highway speed limit is matched.
- While Highway Set Speed Auto Change function is operating, when the highway speed limit changes, Smart Cruise Control set speed automatically changes to the changed speed limit.
- If adjusted Smart Cruise Control set speed is different from the speed limit, Highway Set Speed Auto Change function will be in the standby state.
- If Highway Set Speed Auto Change function has changed to the standby state by driving on a road other than the highway main road, Highway Set Speed Auto Change function will operate again when you drive on the main road again without setting the set speed.

- If Highway Set Speed Auto Change function has changed to the standby state by depressing the brake pedal or pressing the **||**  switch on the steering wheel, press the **||**  switch to restart the function.
- Highway Set Speed Auto Change function does not operate on highway interchanges or junctions.

## **i** Information

- **Highway Set Speed Auto Change function only operates based on the speed limits of the highway, it does not work with speed cameras.**
- **When Highway Set Speed Auto Change function is operating, the vehicle automatically accelerates or decelerates when the highway speed limit changes.**
- **The maximum set speed for Highway Set Speed Auto Change function is 86 mph (140 km/h).**
- **If the speed limit of a new road is not updated in the navigation, Highway Set Speed Auto Change function may not operate properly.**
- **If the speed unit is set to a unit other than the speed unit used in your country, Highway Set Speed Auto Change function may not operate properly.**

### Limitations of Navigation-based Smart Cruise Control

Navigation-based Smart Cruise Control may not operate normally under the following circumstances:

- The navigation is not working properly
- Map information is not transmitted due to infotainment system's abnormal operation
- Speed limit and road information in the navigation is not updated
- The map information and the actual road is different because of real-time GPS data or map information error
- The navigation searches for a route while driving
- GPS signals are blocked in areas such as a tunnel
- A road that divides into two or more roads and joins again
- The driver goes off route set in the navigation
- The route to the destination is changed or canceled by resetting the navigation
- The vehicle enters a service station or rest area
- Android Auto or Car Play is operating
- The navigation cannot detect the current vehicle position (ex: elevated roads including overpass adjacent to general roads or nearby roads exist in a parallel way)
- The navigation is being updated while driving
- The navigation is being restarted while driving
- The speed limit of some sections changes according to the road situations
- Driving on a road under construction
- Driving on a road that is controlled
- There is bad weather, such as heavy rain, heavy snow, etc.
- Driving on a road that is sharply curved

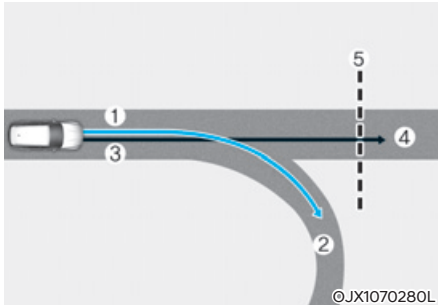

[1] : Set route, [2] : Branch line, [3] : Driving route,  
[4] : Main road, [5] : Curved road section

- When there is a difference between the navigation set route (branch line) and the driving route (main road), Highway Curve Zone Auto Slowdown function may not operate until the driving route is recognized as the main road.
- When the vehicle's driving route is recognized as the main road by maintaining the main road instead of the navigation set route, Highway Curve Zone Auto Slowdown function will operate. Depending on the distance to the curve and the current vehicle speed, vehicle deceleration may not be sufficient or may decelerate rapidly.

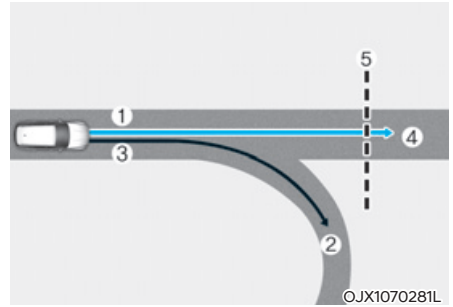

[1] : Set route, [2] : Branch line, [3] : Driving route,  
[4] : Main road, [5] : Curved road section

- When there is a difference between the navigation route (main road) and the driving route (branch line), Highway Curve Zone Auto Slowdown function will operate based on the curve information on the main road.
- When it is judged that you are driving out of the route by entering the highway interchange or junction, Highway Curve Zone Auto Slowdown function will not operate.

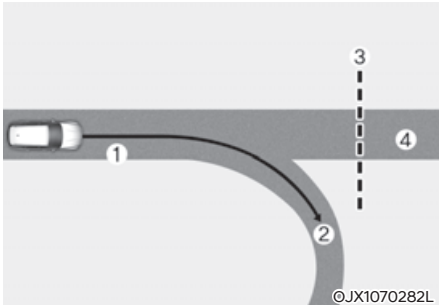

[1] : Driving route, [2] : Branch line,  
[3] : Curved road section, [4] : Main road

- If there is no destination set on the navigation, Highway Curve Zone Auto Slowdown function will operate based on the curve information on the main road.
- Even if you depart from the main road, Highway Curve Zone Auto Slowdown function may temporarily operate due to navigation information of the highway curve section.

### **WARNING**

- Navigation-based Smart Cruise Control is not a substitute for safe driving practices, but a convenience function. Always have your eyes on the road, and it is the responsibility of the driver to avoid violating traffic laws.
- The navigation's speed limit information may differ from the actual speed limit information on the road. It is the driver's responsibility to check the speed limit on the actual driving road or lane.
- Navigation-based Smart Cruise Control will automatically be canceled when you leave the highway main road. Always pay attention to road and driving conditions while driving.
- Navigation-based Smart Cruise Control may not operate due to the existence of leading vehicles and the driving conditions of the vehicle. Always pay attention to road and driving conditions while driving.
- If emergency towing is necessary, we recommend that Navigation-based Smart Cruise Control is turned off due to safety reasons.

- After you pass through a tollgate on a highway, Navigation-based Smart Cruise Control will operate based on the first lane. If you enter one of the other lanes, Navigation-based Smart Cruise Control may not operate properly.
- The vehicle will accelerate if the driver depresses the accelerator pedal while Navigation-based Smart Cruise Control is operating, and the function will not decelerate the vehicle. However, if the accelerator pedal is depressed insufficiently, the vehicle may decelerate.
- If the driver accelerates and releases the accelerator pedal while Navigation-based Smart Cruise Control is operating, the vehicle may not decelerate sufficiently or may rapidly decelerate to a safe speed.
- If the curve is too large or too small, Navigation-based Smart Cruise Control may not operate.

### **i** Information

- The time gap could occur between the navigation's guidance and when Navigation-based Smart Cruise Control operation starts and ends.
- The speed information on the cluster and navigation may differ.
- Even if you are driving at a speed lower than Smart Cruise Control set speed, acceleration may be limited by the curve sections ahead.
- If Navigation-based Smart Cruise Control is operating while leaving the main road to enter an interchange, junction, rest area, etc., the function may operate for a certain period of time.
- Deceleration by Navigation-based Smart Cruise Control may feel it is not sufficient due to road conditions such as uneven road surfaces, narrow lanes, etc.

### **i** Information

This device complies with Part 15 of the FCC rules.

Operation is subject to the following three conditions:

1. This device may not cause harmful interference, and
2. This device must accept any interference received, including interference that may cause undesired operation.
3. Changes or modifications not expressly approved by the party responsible for compliance could void the user's authority to operate the device.

### **i** Information

Radio frequency radiation exposure information:

This equipment complies with FCC radiation exposure limits set forth for an uncontrolled environment.

This equipment should be installed and operated with minimum distance of 8 in. (20 cm) between the radiator (antenna) and your body.

This transmitter must not be co-located or operating in conjunction with any other antenna or transmitter.



## LANE FOLLOWING ASSIST (LFA)

Lane Following Assist is designed to help detect lane markings and/or vehicles on the road, and assists the driver's steering to help center the vehicle in the lane.

### Detecting sensor

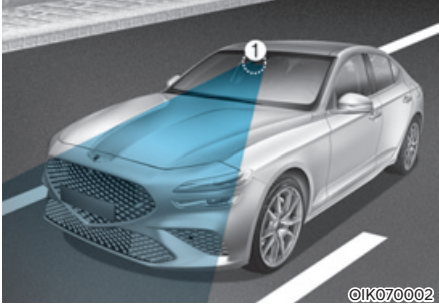

[1] : Front view camera

The front view camera is used as a detecting sensor to help detect lane markings and vehicles in front.

Refer to the picture above for the detailed location of the detecting sensor.

### CAUTION

For more details on the precautions of the front view camera, refer to “Forward Collision-Avoidance Assist (FCA)” section in chapter 7.

### Lane Following Assist Settings Setting features

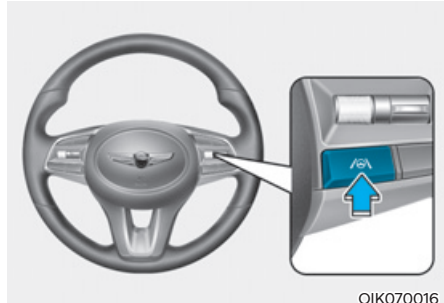

### Turning Lane Following Assist

With the engine on, shortly press the Lane Driving Assist button located on the steering wheel to turn on Lane Following Assist. The white or green  indicator light will illuminate on the cluster.

Press the button again to turn off the function.

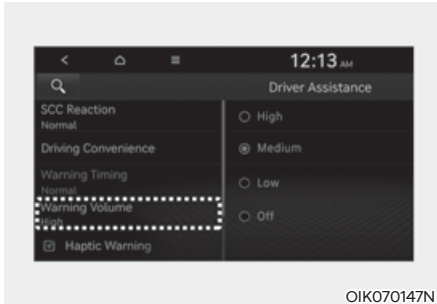

OIK070147N

### Warning Volume

With the engine on, select 'Driver Assistance → Warning Volume' from the Settings menu to change the Warning Volume to 'High', 'Medium', 'Low' or 'Off' for Hands-off warning.

However, even if 'Off' is selected, the Hands-off Warning Volume will not turn off but the volume will sound as 'Low'.

If you change the Warning Volume, the Warning Volume of other Driver Assistance systems may change.

## Lane Following Assist Operation

### Warning and control



OIK070090L

### Lane Following Assist

If the vehicle ahead and/or both lane markings are detected and your vehicle speed is below 120 mph (200 km/h), the green  indicator light will illuminate on the cluster, and Lane Following Assist will help center the vehicle in the lane by assisting the steering wheel.

### CAUTION

When the steering wheel is not assisted, the green  indicator light will blink and change to white.



### Hands-off warning

If the driver takes their hands off the steering wheel for several seconds, the 'Place hands on the steering wheel' warning message will appear and an audible warning will sound in stages.

First stage : Warning message

Second stage : Warning message (red steering wheel) and audible warning

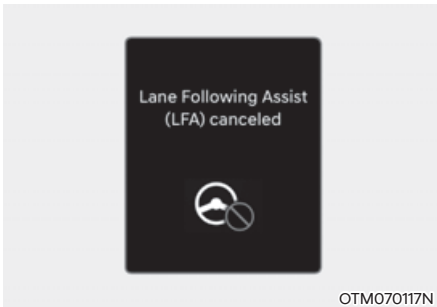

If the driver still does not have their hands on the steering wheel after the hands-off warning, the 'Lane Following Assist (LFA) canceled' warning message will appear and Lane Following Assist will be automatically canceled.

### WARNING

- The steering wheel may not be assist if the steering wheel is held very tight or the steering wheel is steered over a certain degree.
- Lane Following Assist does not operate at all times. It is the responsibility of the driver to safely steer the vehicle and to maintain the vehicle in its lane.
- The hands-off warning message may appear late depending on road conditions. Always have your hands on the steering wheel while driving.
- If the steering wheel is held very lightly, the hands-off warning message may appear because Lane Following Assist may not recognize that the driver has their hands on the steering wheel.
- If you attach objects to the steering wheel, the hands-off warning may not work properly.

## **i** Information

- You may change settings from the infotainment system (Vehicle Settings), whichever option that is provided with your vehicle. For more details, see "Vehicle Settings" section in supplied Infotainment Manual.
- When both lane markings are detected, the lane lines on the cluster will change from grey to white.

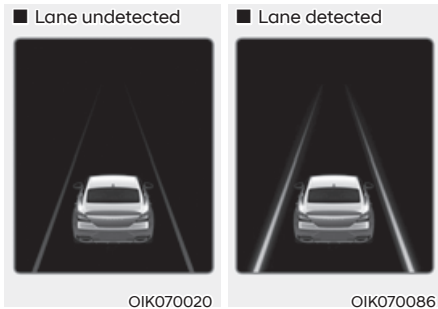

- If lane markings are not detected, steering wheel control by Lane Following Assist can be limited depending on whether a vehicle is in front or the driving conditions of the vehicle.
- Even though the steering is assisted by Lane Following Assist, the driver may control the steering wheel.
- The steering wheel may feel heavier or lighter when the steering wheel is assisted by Lane Following Assist than when it is not.

## Lane Following Assist Malfunction and Limitations

### *Lane Following Assist malfunction*



When Lane Following Assist is not working properly, the 'Check Lane Following Assist (LFA) system' warning message will appear on the cluster. If this occurs, have the vehicle inspected by an authorized retailer of Genesis Branded products.

### **Limitations of Lane Following Assist**

For more details on Lane Following Assist limitations, refer to "Lane Keeping Assist (LKA)" section in chapter 7.

## **!** WARNING

**For more details on Lane Following Assist precautions, refer to "Lane Keeping Assist (LKA)" section in chapter 7.**

## HIGHWAY DRIVING ASSIST (HDA) (IF EQUIPPED)

### Basic function

Highway Driving Assist is designed to help detect vehicles and lanes ahead, and help maintain distance from the vehicle ahead, maintain the set speed, and help center the vehicle in the lane while driving on the highway.

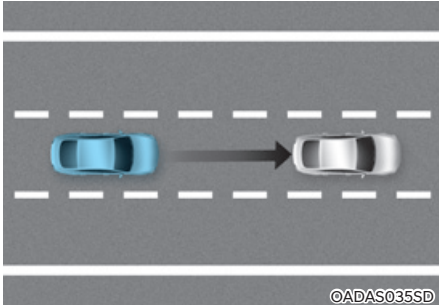

### **i** Information

- The Highway Driving Assist is available only on controlled access road of certain highways.
  - \* **Controlled access road indicates roads with limited entrances and exits that allow uninterrupted high speed traffic flow.**

### Detecting sensor

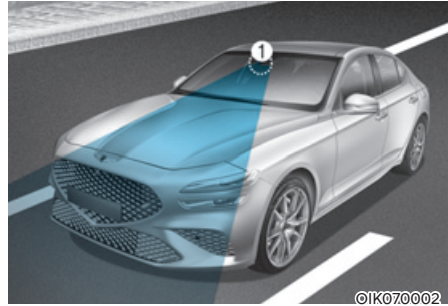

- [1] : Front view camera,  
[2] : Front radar

Refer to the picture above for the detailed location of the detecting sensors.



### CAUTION

For more details on the precautions of the detecting sensors, refer to “Forward Collision-Avoidance Assist (FCA)” section in chapter 7.

## Highway Driving Assist Settings

### Setting features

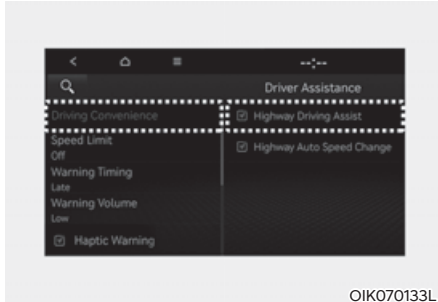

OIK070133L

### Highway Driving Assist

With the engine on, select or deselect 'Driver Assistance → Driving Convenience' from the Settings menu to set whether or not to use the following function(s).

- If 'Highway Driving Assist' is selected, it helps maintain distance from the vehicle ahead, maintain the set speed, and helps center the vehicle in the lane.

### **i** Information

- **If there is a problem with the function(s), the settings cannot be changed. Have the system inspected by an authorized retailer of Genesis Branded products.**
- **If the engine is restarted, the function(s) will maintain the last setting.**

### **!** WARNING

**For your safety, change the Settings after parking the vehicle at a safe location.**

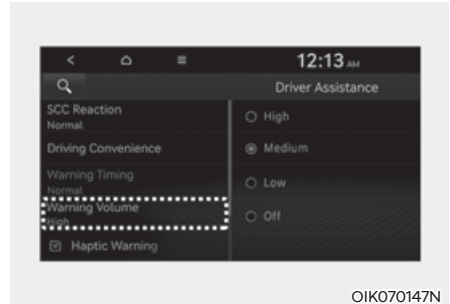

OIK070147N

### Warning Volume

With the engine on, select 'Driver Assistance → Warning Volume' from the Settings menu to change the Warning Volume to 'High', 'Medium', 'Low' or 'Off' for Highway Driving Assist.

However, even if 'Off' is selected, the Hands-off Warning Volume will not turn off but the volume will sound as 'Low'.

If you change the Warning Volume, the Warning Volume of other Driver Assistance systems may change.

## Highway Driving Assist Operation

### Basic function

#### Display and control

You can see the status of the Highway Driving Assist operation in the Driving Assist mode on the cluster. Refer to “LCD Display Modes” section in chapter 4.

Highway Driving Assist will be displayed as below depending on the status of the function.

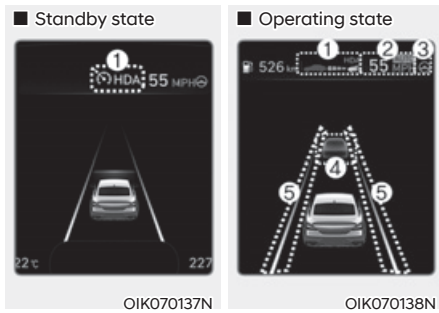

- (1) Highway Driving Assist indicator, whether there is a vehicle ahead and the selected distance level are displayed.

\* Highway Driving Assist indicator

- Green HDA : Operating state
- White HDA : Standby state

- (2) Set speed is displayed.
- (3) Lane Following Assist indicator displayed.
- (4) Whether there is a vehicle ahead and the selected vehicle distance are displayed.
- (5) Whether the lane is detected or not is displayed.

\* **For more details and the limitations of the function on Lane Following Assistance, refer to "Lane Following Assistance (LFA)".**

\* **For more details and the limitations of the function on Smart Cruise Control, refer to "Smart Cruise Control (SCC)".**

#### System operating

Highway Driving Assist will operate when entering or driving on the main road of highways, and satisfying all the following conditions:

- Lane Following Assist is operating
- Smart Cruise Control is operating

### i Information

- **While driving on the highway, if Smart Cruise Control starts operating, Highway Driving Assist will operate.**
- **When entering the main roads of highways, Highway Driving Assist will not turn on if the Lane Following Assist is turned off even when Smart Cruise Control is operating.**

- Restarting after stopping



When Highway Driving Assist is operating, your vehicle will stop if the vehicle ahead of you stops. Also, if the vehicle ahead of you starts moving within 30 seconds after the stop, your vehicle will start as well. In addition, after the vehicle has stopped and 30 seconds have passed, the 'Use switch or pedal to accelerate' message will appear on the cluster. Depress the accelerator pedal or push the + switch, - switch or  switch to start driving.

- Hands-off warning



If the driver takes their hands off the steering wheel for several seconds, the 'Place hands on the steering wheel' warning message will appear and an audible warning will sound in stages.

First stage : Warning message

Second stage : Warning message (red steering wheel) and audible warning





If the driver still does not have their hands on the steering wheel after the hands-off warning, the 'Highway Driving Assist (HDA) system canceled' warning message will appear and Highway Driving Assist will be automatically canceled.

### Highway Driving Assist standby

When Smart Cruise Control is temporarily canceled while Highway Driving Assist is operating, Highway Driving Assist will be in the standby state. At this time, Lane Following Assist will operate normally.

## Highway Driving Assist Malfunction and Limitations

### Highway Driving Assist malfunction



When Highway Driving Assist is not working properly, the 'Check Highway Driving Assist (HDA) system' warning message will appear, and the  warning light will illuminate on the cluster. Have the vehicle inspected by an authorized retailer of Genesis Branded products.



## WARNING

- The driver is responsible for controlling the vehicle for safe driving.
- Always have your hands on the steering wheel while driving.
- Highway Driving Assist is a supplemental function that assists the driver in driving the vehicle and is not a complete autonomous driving system. Always check road conditions, and if necessary, take appropriate actions to drive safely.
- Always have your eyes on the road, and it is the responsibility of the driver to avoid violating traffic laws. The vehicle manufacturer is not responsible for any traffic violation or accidents caused by the driver.
- Highway Driving Assist may not be able to recognize all traffic situations. Highway Driving Assist may not detect possible collisions due to limitations of the function. Always be aware of the limitations of the function. Obstacles such as vehicles, motorcycles, bicycles, pedestrians, or unspecified objects or structures such as guardrails, tollgate, etc. that may collide with the vehicle may not be detected.
- Highway Driving Assist will turn off automatically under the following situations:
  - Driving on roads that Highway Driving Assist does not operate, such as a rest area, intersection, junction, etc.
  - The navigation does not operate properly such as when the navigation is being updated or restarted
- Highway Driving Assist may inadvertently operate or turn off depending on road conditions (navigation information) and surroundings.
- Lane Following Assist function may be temporarily disabled when the front view camera cannot detect lanes properly or the hands-off warning is on.
- You may not hear the warning sound of Highway Driving Assist if the surrounding is noisy.
- If the vehicle is driven at high speed above a certain speed at a curve, your vehicle may drive to one side or may depart from the driving lane.
- If emergency towing is necessary, we recommend that Highway Driving Assist is turned off due to safety reasons.
- The hands-off warning message may appear early or late depending on how the steering wheel is held or road conditions. Always have your hands on the steering wheel while driving.
- For your safety, please read the owner's manual before using the Highway Driving Assist.
- Highway Driving Assist will not operate when the engine is started, or when the detecting sensors or navigation is being initialized.

### **Limitations of Highway Driving Assist**

Highway Driving Assist may not operate normally, or may not operate under the following circumstances:

- The map information and the actual road is different because the navigation is not updated
- The map information and the actual road is different because of real-time GPS data or map information error
- The infotainment system is overloaded by simultaneously performing functions such as route search, video playback, voice recognition, etc.
- GPS signals are blocked in areas such as a tunnel
- The driver goes off course or the route to the destination is changed or canceled by resetting the navigation
- The vehicle enters a service station or rest area
- Android Auto or Car Play is operating
- The navigation cannot detect the current vehicle position (ex: elevated roads including overpass adjacent to general roads or nearby roads exist in a parallel way)

### **i Information**

For more details on the limitations of the front view camera, front radar, front corner radar and rear corner radar, refer to “Forward Collision-Avoidance Assist (FCA)” section in chapter 7.

### **i Information**

This device complies with Part 15 of the FCC rules.

Operation is subject to the following three conditions:

1. This device may not cause harmful interference, and
2. This device must accept any interference received, including interference that may cause undesired operation.
3. Changes or modifications not expressly approved by the party responsible for compliance could void the user's authority to operate the device.

### **i Information**

Radio frequency radiation exposure information:

This equipment complies with FCC radiation exposure limits set forth for an uncontrolled environment.

This equipment should be installed and operated with minimum distance of 8 in. (20 cm) between the radiator (antenna) and your body.

This transmitter must not be co-located or operating in conjunction with any other antenna or transmitter.

## REAR VIEW MONITOR (RVM) (IF EQUIPPED)

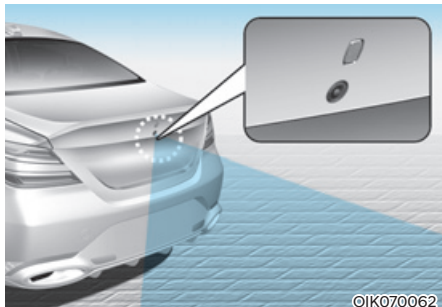

Rear View Monitor will show the area behind the vehicle to assist you when parking or backing up.

### **Detecting sensor**

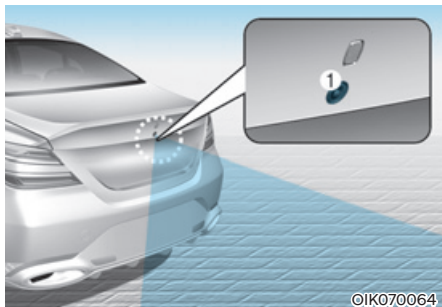

[1] : Rear view camera

Refer to the picture above for the detailed location of the detecting sensor.

## Rear View Monitor Settings

### **Camera settings**

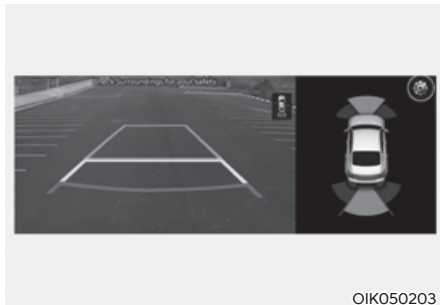

- You can change Rear View Monitor 'Display Contents' or 'Display Settings' by touching the setup icon (⚙️) on the screen while Rear View Monitor is operating, or selecting 'Driver Assistance → Parking Safety → Camera Settings' from the Settings menu while the engine is on.
- In the Display Contents, you can change settings for 'Rear View', and in the Display Settings, you can change the screen's 'Brightness' and 'Contrast'.

## Rear View Monitor Operation

### Operating button



#### Parking/View button

Press the Parking/View button (1) to turn on Rear View Monitor.

Press the button again to turn off the function.

### Rear view

#### Operating conditions

- Shift the gear to R (Reverse), the image will appear on the screen.
- Press the Parking/View button (1) while the gear is in P (Park), the image will appear on the screen. However, parking guidance is not displayed.

#### Off conditions

- The rear view cannot be turned off when the gear is in R (Reverse).
- Press the Parking/View button (1) again while the gear is in P (Park) with the rear view on the screen, the rear view will turn off.
- Shift the gear from R (Reverse) to P (Park), the rear view will turn off.

### Extended rear view

The rear view will maintain showing on the screen to help you when parking. However, parking guidance is not displayed.

#### Operating conditions

Shift the gear from R (Reverse) to N (Neutral) or D (Drive), the rear view will appear on the screen.

#### Off conditions

- When the vehicle speed is above 6 mph (10 km/h), the rear view will turn off.
- Shift the gear to P (Park), the rear view will turn off.

### Rear top view



When you touch the **i** icon, the top view is displayed on the screen and shows the distance from the vehicle in the back of your vehicle while parking.

### Rear View Monitor Malfunction and Limitations

#### Rear View Monitor malfunction

When Rear View Monitor is not working properly, or the screen flickers, or the camera image does not display normally, have the vehicle inspected by an authorized retailer of Genesis Branded products.

#### Limitations of Rear View Monitor

When the vehicle is stopped for a long time in winter or when the vehicle is parked in an indoor parking lot, the exhaust fumes may temporarily blur the image.



#### WARNING

- The rear view camera does not cover the complete area behind the vehicle. The driver should always check the rear area directly through the inside and side view mirror before parking or backing up.
- The image shown on the screen may differ from the actual distance of the object. Make sure to directly check the vehicle's surroundings for safety.
- Always keep the rear view camera lens clean. If the lens is covered with foreign material, it may adversely affect camera performance and Rear View Monitor may not operate normally. However, do not use chemical solvents such as strong detergents containing high alkaline or volatile organic solvents (gasoline, acetone etc.). This may damage the camera lens.

## SURROUND VIEW MONITOR (SVM) (IF EQUIPPED)



Surround View Monitor will assist in parking using the cameras installed on the vehicle and displays images around the vehicle through the infotainment system screen.

- Parking Assist View function helps the driver to see the surroundings of the vehicle in a parking situation in various view modes.
- Rear View while driving function helps the driver to check the rear view on the screen while driving.

### Detecting sensor

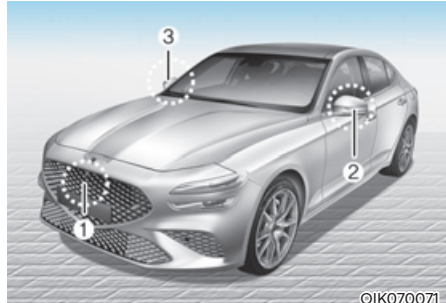

- [1] : SVM-front view camera,
- [2],[3] : SVM-side view camera  
(under the side view mirror),
- [4] : SVM-rear view camera

Refer to the picture above for the detailed location of the detecting sensors.

## Surround View Monitor Settings

### Camera settings



- You can change Surround View Monitor 'Display Contents' or 'Display Settings' by touching the setup icon (⚙️) on the screen while Surround View Monitor is operating, or selecting 'Driver Assistance → Parking Safety → Camera Settings' from the Settings menu while the engine is on.
- In the Display Contents, you can change settings for 'Top View Parking Guidance', 'Rear View Parking Guidance' and 'Parking Distance Warning'.
- In the Display Settings, you can change the screen's 'Brightness' and 'Contrast'.

## Top View Parking Guidance

### ■ Front top view



©IK070139L

### ■ Rear top view



©IK070101L

- When the 'Top View Parking Guidance' is selected, parking guidance is displayed on the right side of the Surround View Monitor screen.
- You may see the front top view or the rear top view when using Top View Parking Guidance.



### Rear View Parking Guidance

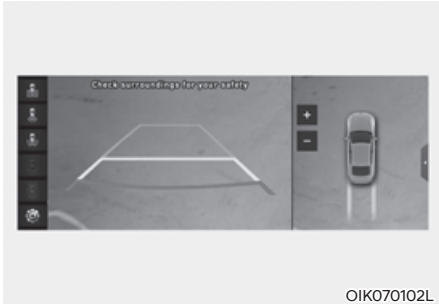

- When the 'Rear View Parking Guidance' is selected, parking guidance is displayed in the rear view.
- The horizontal guideline of the Rear View Parking Guidance shows the distance of 1.6 ft. (0.5 m), 3.3 ft. (1 m) and 7.6 ft. (2.3 m) from the vehicle.

### Parking Distance Warning

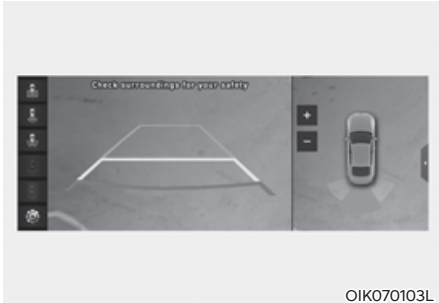

- When the 'Parking Distance Warning' is selected, parking distance warning is displayed on the right side of the Surround View Monitor screen.
- The image will be displayed only when Parking Distance Warning is warning the driver.

### Surround View Monitor Auto On

With the engine on, select 'Driver Assistance → Parking Safety → Surround View Monitor Auto On' from the Settings menu to use the function.

To use this function, refer to "Surround View Monitor Operation".

### Surround View Monitor Operation

#### Operating button



- Press the Parking/View button (1) to turn on Surround View Monitor. Press the button again to turn off the function.
- Other view modes can be selected by touching the view icons (2) on the Surround View Monitor screen.
- When one of the infotainment system button (3) is pressed without the gear in R (Reverse), Surround View Monitor will turn off.

### **Front view**

The front image is displayed on the screen when the gear is in N (Neutral) or D (Drive) to assist in parking. The front view has a top view/front view/side view.

#### **Operating conditions**

- Front view function will operate when the following conditions are satisfied:
  - While the infotainment system screen is being displayed, press the Parking/View button (1) briefly when the gear is in D (Drive) or N (Neutral) and the vehicle speed is below 6 mph (10 km/h).
- Surround View Monitor Auto On function will operate when the following conditions are satisfied:
  - With 'Driver Assistance → Parking Safety → Surround View Monitor Auto On' selected from the Settings menu, the front parking assist view screen is displayed when Parking Distance Warning warns the driver while driving in D (Drive).

#### **Off conditions**

- Press the Parking/View button (1) again, the image will turn off.
- When the vehicle speed is above 6 mph (10 km/h) with the gear in D (Drive), Surround View Monitor will turn off and the screen will change back to the previous infotainment system screen. Although you drive below 6 mph (10 km/h) again, Surround View Monitor will not turn on.
- Press one of the infotainment system button (3), the screen will change to the infotainment system screen.
- Shift the gear to P (Park), the image will turn off.

### **Rear view**

The rear image is displayed on the screen when the gear is in R (Reverse) or P (Park) to assist in parking. The rear view has a top view/rear view/side view.

#### **Operating conditions**

- Shift the gear to R (Reverse), the image will appear on the screen.
- Press the Parking/View button (1) while the gear is in P (Park), the image will appear on the screen. However, parking guidance is not displayed.

#### **Off conditions**

- The image cannot be turned off when the gear is in R (Reverse).
- Shift the gear from R (Reverse) to P (Park), the image will turn off.
- Press the Parking/View button (1) again while the gear is in P (Park) with the image on the screen.

## Surround View Monitor Malfunction and Limitations

### **Surround View Monitor malfunction**

When Surround View Monitor is not working properly, or the screen flickers, or the camera image does not display normally, have the vehicle inspected by an authorized retailer of Genesis Branded products.

### **Limitations of Surround View Monitor**

- When the vehicle is stopped for a long time in winter or when the vehicle is parked in an indoor parking lot, the exhaust fumes may temporarily blur the image.
- The screen may be displayed abnormally, and an icon will appear at the top left side of the screen under the following circumstances:
  - The trunk is opened
  - The driver or front passenger door is opened
  - The side view mirror is folded



### **WARNING**

- **ALWAYS** look around your vehicle to make sure there are no objects or obstacles before moving the vehicle. What you see on the screen may differ from the actual vehicle's location.
- The image shown on the screen may differ from the actual distance of the object. Make sure to directly check the vehicle's surroundings for safety.
- When the rear view is displayed while driving, an icon (📺) appears at the top right side of the infotainment system screen to inform the driver the rear view is being displayed. Do not be confused with the front wide view image.
- Surround View Monitor is designed to be used on a flat surface. Therefore, if used on roads with different heights such as curbs and speed bumps, the image in the screen may not look correct.
- Always keep the camera lens clean. If the lens is covered with foreign material, it may adversely affect camera performance and Surround View Monitor may not operate normally. However, do not use chemical solvents such as strong detergents containing high alkaline or volatile organic solvents (gasoline, acetone etc.). This may damage the camera lens.

## REAR CROSS-TRAFFIC COLLISION-AVOIDANCE ASSIST (RCCA)

Rear Cross-Traffic Collision-Avoidance Assist is designed to help detect vehicles approaching from the left and right side while your vehicle is reversing, and warn the driver that a collision is imminent with a warning message and an audible warning. Also, braking is assisted to help prevent a collision.

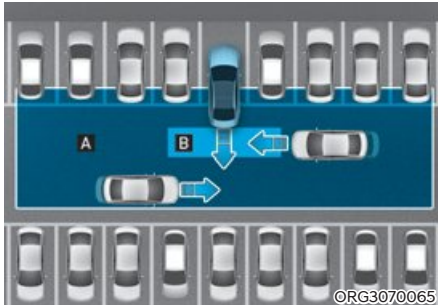

[A] : Rear Cross-Traffic Collision Warning operating range

[B] : Rear Cross-Traffic Collision-Avoidance Assist operating range



### CAUTION

The time of warning may vary depending on vehicle speed of the approaching vehicle.



### Information

In the following text, Rear Cross-Traffic Collision Warning and Rear Cross-Traffic Collision-Avoidance Assist will be referred as Rear Cross-Traffic Safety system.

### Detecting sensor

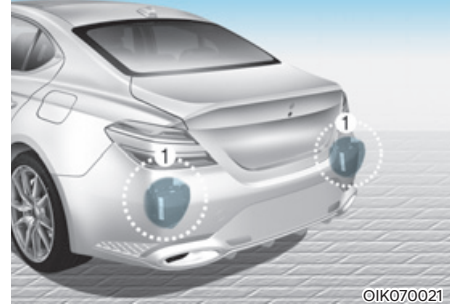

[1] : Rear corner radar

Refer to the picture above for the detailed location of the detecting sensors.



### Information

For more details on the precautions of the rear corner radar, refer to “Blind-Spot Collision-Avoidance Assist (BCA)” section in chapter 7.

## Rear Cross-Traffic Safety system Settings

### Setting functions for features

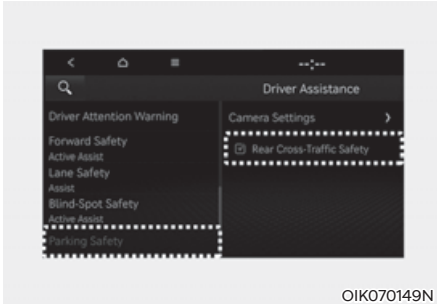

### Rear Cross-Traffic Safety

With the engine on, select 'Driver Assistance → Parking Safety → Rear Cross-Traffic Safety' from the Settings menu to turn on Rear Cross-Traffic Safety system and deselect to turn off the system.



### WARNING

**When the engine is restarted, Rear Cross-Traffic Safety system will always turn on. However, if 'Off' is selected after the engine is restarted, the driver should always be aware of the surroundings and drive safely.**



### Information

Settings for Rear Cross-Traffic Safety system include Rear Cross-Traffic Collision Warning and Rear Cross-Traffic Collision-Avoidance Assist.

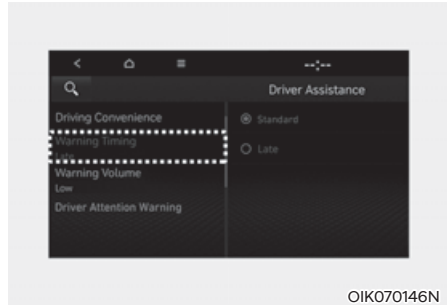

### Warning Timing

With the engine on, select 'Driver Assistance → Warning Timing' from the Settings menu to change the initial warning activation time for Rear Cross-Traffic Safety system.

When the vehicle is first delivered, Warning Timing is set to 'Standard'. If you change the Warning Timing, the warning time of other Driver Assistance systems may change.

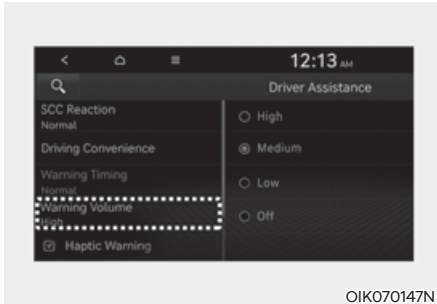

OIK070147N

### Warning Volume

With the engine on, select 'Driver Assistance → Warning Volume' from the Settings menu to change the Warning Volume to 'High', 'Medium', 'Low' or 'Off' for Rear Cross-Traffic Safety system.

However, when Warning Volume is turned off, the steering wheel vibration function will turn on if it was turned off.

If you change the Warning Volume, the Warning Volume of other Driver Assistance systems may change.

### CAUTION

- The setting of the Warning Timing and Warning Volume applies to all functions of the Rear Collision-Avoidance Assist.
- Even though 'Standard' is selected for Warning Timing, if the vehicles from the left and right side approach at high speed, the initial warning activation time may seem late.
- Select 'Late' for Warning Timing when traffic is light and when driving speed is slow.

### Information

If the engine is restarted, Warning Timing and Warning Volume will maintain the last setting.

## Rear Cross-Traffic Safety system Operation

### Warning and control

Rear Cross-Traffic Safety system will warn and control the vehicle depending on collision level: 'Collision Warning', 'Emergency Braking' and 'Stopping vehicle and ending brake control'.



OHY059005

OIK070074



©IK070075

### Collision Warning

- To warn the driver of an approaching vehicle from the rear left/right side of your vehicle, the warning light on the side view mirror will blink and a warning will appear on the cluster. At the same time, an audible warning will sound. If Rear View Monitor is operating, a warning will also appear on the infotainment system screen.

- Rear Cross-Traffic Safety system will operate when all the following conditions are satisfied:
  - The gear is shifted to R (Reverse)
  - The vehicle speed is below 5 mph (8 km/h)
  - The approaching vehicle is within approximately 82 ft. (25 m) from the left and right side of your vehicle
  - The speed of the vehicle approaching from the left and right is above 3 mph (5 km/h)

### **i** Information

**If the operating conditions are satisfied, there will be a warning whenever the vehicle approaches from the left or right side even though your vehicle speed is 0 mph (0 km/h).**



### Emergency Braking

- To warn the driver of an approaching vehicle from the rear left/right side of your vehicle, the warning light on the side view mirror will blink and, the 'Emergency Braking' warning message will appear on the cluster. At the same time, an audible warning will sound. If Rear View Monitor is operating, a warning will also appear on the infotainment system screen.

- Rear Cross-Traffic Safety system will operate when all the following conditions are satisfied:
  - The gear is shifted to R (Reverse)
  - The vehicle speed is below 5 mph (8 km/h)
  - The approaching vehicle is within approximately 5 ft. (1.5 m) from the left and right side of your vehicle
  - The speed of the vehicle approaching from the left and right is above 3 mph (5 km/h)
- Emergency braking will be assisted to help prevent collision with approaching vehicles from the left and right.



## WARNING

### Brake control will end when:

- **The approaching vehicle is out of the detecting range**
- **The approaching vehicle passes behind your vehicle**
- **The approaching vehicle does not drive toward your vehicle**
- **The approaching vehicle speed slows down**
- **The driver depresses the brake pedal with sufficient power**

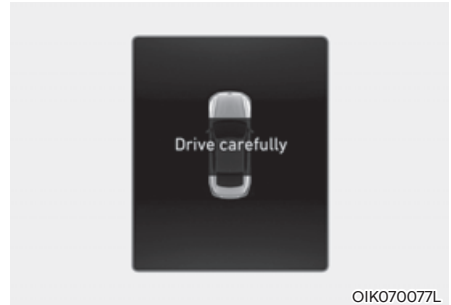

### Stopping vehicle and ending brake control

- When the vehicle is stopped due to emergency braking, the 'Drive carefully' warning message will appear on the cluster.
- For your safety, the driver should depress the brake pedal immediately and check the surroundings.
- Brake control will end after the vehicle is stopped by emergency braking for approximately 2 seconds.
- During emergency braking, braking control by Rear Cross-Traffic Safety system will automatically cancel when the driver excessively depresses the brake pedal.





## WARNING

Take the following precautions when using Rear Cross-Traffic Safety system:

- For your safety, change the Settings after parking the vehicle at a safe location.
- If any other system's warning message is displayed or audible warning is generated, Rear Cross-Traffic Safety system's warning message may not be displayed and audible warning may not be generated.
- You may not hear the warning sound of Rear Cross-Traffic Safety system if the surrounding is noisy.
- Rear Cross-Traffic Safety system may not operate if the driver applies the brake pedal to avoid collision.
- During Rear Cross-Traffic Safety system operation, the vehicle may stop suddenly injuring passengers and shifting loose objects. Always have the seat belt on and keep loose objects secured.
- Even if there is a problem with Rear Cross-Traffic Safety system, the vehicle's basic braking performance will operate normally.
- When Rear Cross-Traffic Safety system is operating, braking control by the system will automatically cancel when the driver excessively depresses the accelerator pedal.
- Rear Cross-Traffic Safety system does not operate in all situations or cannot avoid all collisions.
- Rear Cross-Traffic Safety system may warn the driver late or may not warn the driver depending on the road and driving conditions.

- The driver should hold the responsibility to control the vehicle. Do not solely depend on Rear Cross-Traffic Safety system. Rather, maintain a safe braking distance, and if necessary, depress the brake pedal to reduce driving speed or to stop the vehicle.
- Never deliberately operate Rear Cross-Traffic Safety system on people, animal, objects, etc. It may cause serious injury or death.



## CAUTION

The brake control may not operate properly depending on the status of ESC (Electronic Stability Control).

There will only be a warning when:

- The ESC (Electronic Stability Control) warning light is on
- ESC (Electronic Stability Control) is engaged in a different function



## Information

If the system assists you with braking, the driver check vehicle surroundings.

- Brake control will end when the driver depresses the brake pedal with sufficient power.
- After shifting the gear to R (Reverse), braking control will operate once for left and right vehicle approach.

## Rear Cross-Traffic Safety system Malfunction and Limitations

### Rear Cross-Traffic Safety system malfunction

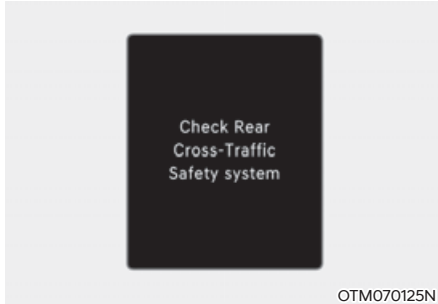

OTM070125N

When Rear Cross-Traffic Safety system is not working properly, the 'Check Rear Cross-Traffic Safety system(s)' warning message will appear on the cluster, and the system will turn off automatically or the system will be limited. Have the vehicle inspected by an authorized retailer of Genesis Branded products.

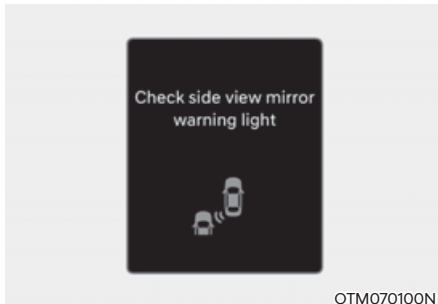

OTM070100N

When the side view mirror warning light is not working properly, the 'Check side view mirror warning light' warning message will appear on the cluster. Have the vehicle inspected by an authorized retailer of Genesis Branded products.

### Rear Cross-Traffic Safety system disabled



OTM070124N

When the rear bumper around the rear-side radar or sensor is covered with foreign material, such as snow or rain, or installing a trailer or carrier, it can reduce the detecting performance and temporarily limit or disable Rear Cross-Traffic Safety system.

If this occurs, the 'Rear Cross-Traffic Safety system disabled. Radar blocked' warning message will appear on the cluster.

The system will operate normally when such foreign material or trailer, etc. is removed.

If the system does not operate normally after it is removed, have the vehicle inspected by an authorized retailer of Genesis Branded products.

**WARNING**

- Even though the warning message does not appear on the cluster, Rear Cross-Traffic Safety system may not operate properly.
- Rear Cross-Traffic Safety system may not operate properly in an area (for example: open terrain), where any substance are not detected after turning ON the engine.

**CAUTION**

Turn off Rear Cross-Traffic Safety system to install a trailer, carrier, etc., or remove the trailer, carrier, etc. to use Rear Cross-Traffic Safety system.

**Limitations of Rear Cross-Traffic Safety system**

Rear Cross-Traffic Safety system may not operate normally, or the system may operate unexpectedly under the following circumstances:

- Departing from where trees or grass are overgrown
- Departing from where roads are wet
- Speed of the approaching vehicle is fast or slow

Braking control may not work, driver's attention is required in the following circumstances:

- The vehicle severely vibrates while driving over a bumpy road, uneven road or concrete patch
- Driving on a slippery surface due to snow, water puddle, ice, etc.
- The tire pressure is low or a tire is damaged
- The brake is reworked

**Information**

For more details on the limitations of the rear corner radar, refer to "Blind-Spot Collision-Avoidance Assist (BCA)" section in chapter 7.

**WARNING**

- Driving near a vehicle or structure

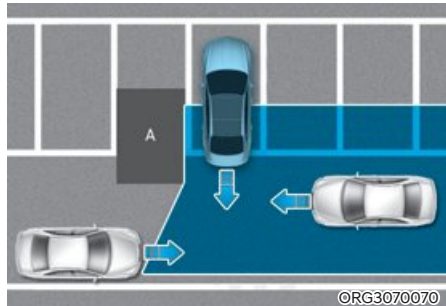

[A] : Structure

**Rear Cross-Traffic Safety system may be limited when driving near a vehicle or structure, and may not detect the vehicle approaching from the left or right. If this occurs, the system may not warn the driver or control the brakes when necessary.**

**Always check your surroundings while backing up.**

- When the vehicle is in a complex parking environment

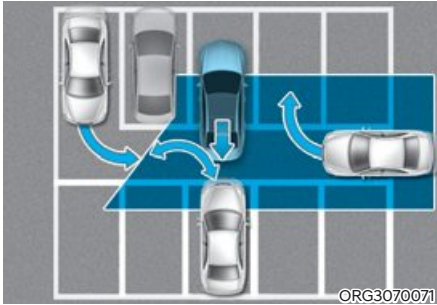

Rear Cross-Traffic Safety system may detect vehicles which are parking or pulling out near your vehicle (for example: a vehicle leaving beside your vehicle, a vehicle parking or pulling out in the rear area, a vehicle approaching your vehicle making a turn, etc.). If this occurs, the system may unnecessarily warn the driver and control the brake.

Always check your surroundings while backing up.

- When the vehicle is parked diagonally

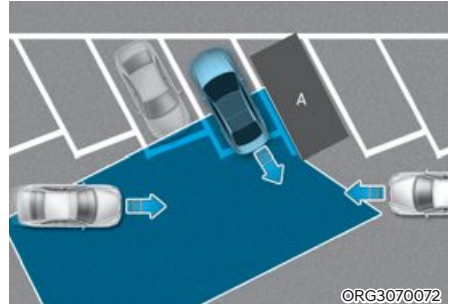

[A] : Vehicle

Rear Cross-Traffic Safety system may be limited when backing up diagonally, and may not detect the vehicle approaching from the left or right. If this occurs, the system may not warn the driver or control the brakes when necessary.

Always check your surroundings while backing up.

- When the vehicle is on or near a slope

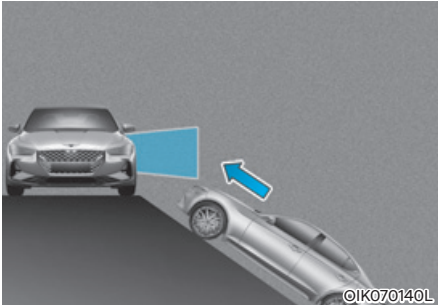

**Rear Cross-Traffic Safety system may be limited when the vehicle is on an uphill or downhill slope, or near it, and may not detect the vehicle approaching from the left or right. If this occurs, the system may not warn the driver or control the brakes when necessary.**

**Always check your surroundings while backing up.**

- Pulling into the parking space where there is a structure

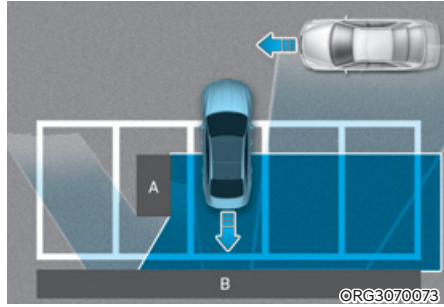

[A] : Structure, [B] :Wall

**Rear Cross-Traffic Safety system may detect vehicles passing by in front of you when parking in reverse into a parking space with a wall or structure in the rear or side area. If this occurs, the system may unnecessarily warn the driver and control the brake.**

**Always check your surroundings while backing up.**

- When the vehicle is parked rearward

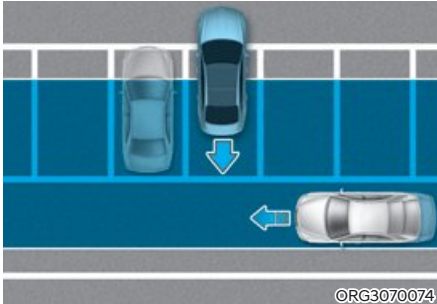

Rear Cross-Traffic Safety system may detect vehicles passing by behind you when parking in reverse into a parking space. If this occurs, the system may unnecessarily warn the driver and control the brake.

Always check your surroundings while backing up.



## WARNING

If emergency towing is necessary, we recommend that Rear Cross-Traffic Safety system is turned off due to safety reasons.

- Rear Cross-Traffic Safety system may not operate normally if interfered by strong electromagnetic waves.
- Rear Cross-Traffic Safety system may not operate for 3 seconds after the vehicle is started, or the rear corner radars are initialized.

## **i** Information

This device complies with Part 15 of the FCC rules.

Operation is subject to the following three conditions:

1. This device may not cause harmful interference, and
2. This device must accept any interference received, including interference that may cause undesired operation.
3. Changes or modifications not expressly approved by the party responsible for compliance could void the user's authority to operate the device.

## **i** Information

Radio frequency radiation exposure information:

This equipment complies with FCC radiation exposure limits set forth for an uncontrolled environment.

This equipment should be installed and operated with minimum distance of 8 in. (20 cm) between the radiator (antenna) and your body.

This transmitter must not be co-located or operating in conjunction with any other antenna or transmitter.

## REVERSE PARKING DISTANCE WARNING (PDW) (IF EQUIPPED)

Reverse Parking Distance Warning will help warn the driver if an obstacle is detected within a certain distance when the vehicle is moving in reverse at low speeds.

### Detecting sensor

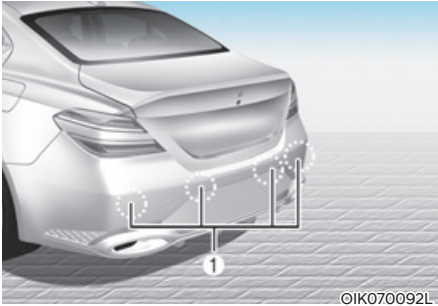

[1] : Rear ultrasonic sensors

Refer to the picture above for the detailed location of the detecting sensors.

### Reverse Parking Distance Warning Settings

#### Warning Volume

With the engine on, ON position, select 'Driver Assistance → Warning Volume' from the Settings menu to change the Warning Volume to 'High', 'Medium', 'Low' or 'Off' for Reverse Parking Distance Warning.

However, even if 'Off' is selected, Warning Volume of Reverse Parking Distance Warning will not turn off but the volume will sound as 'Low'.



If you change the Warning Volume, the Warning Volume of other Driver Assistance systems may change.

### Reverse Parking Distance Warning Operation

- Reverse Parking Distance Warning will activate when backing up with the Engine Start/Stop button in the ON position. However, if vehicle speed exceeds 3 mph (5 km/h), the system may not detect objects.
- If vehicle speed exceeds 6 mph (10 km/h), the system will not warn you even though objects are detected.
- When more than two objects are sensed at the same time, the closest one will be recognized first.

### Reverse Parking Distance Warning

- Reverse Parking Distance Warning will operate when the gear is in R (Reverse).
- Reverse Parking Distance Warning detects a person, animal or object in the rear when the vehicle's rearward speed is below 6 mph (10 km/h).

Distance from object	Warning indicator	Warning sound
	Driving rearward	
24~48 in. (60~120 cm)		Buzzer beeps intermittently
12~24 in. (30~60 cm)		Beeps more frequently
12 in. (within 30 cm)		Beeps continuously

- The corresponding indicator will illuminate whenever each ultrasonic sensor detects a person, animal or object in its sensing range. Also an audible warning will sound.
- When more than two objects are detected at the same time, the closest one will be warned with an audible warning.
- The shape of the indicator in the illustration may differ from the actual vehicle.

### Reverse Parking Distance Warning Malfunction and Precautions

#### Reverse Parking Distance Warning malfunction

After starting the engine, a beep will sound when the gear is shifted to R (Reverse) to indicate Reverse Parking Distance Warning is operating normally.

However, if one or more of the following occurs, first check whether the ultrasonic sensor is damaged or blocked with foreign material. If it still does not work properly, have the vehicle inspected by an authorized retailer of Genesis Branded products.

- The audible warning does not sound.
- The buzzer sounds intermittently.
- The 'Parking sensor error or blockage' warning message appears on the cluster.

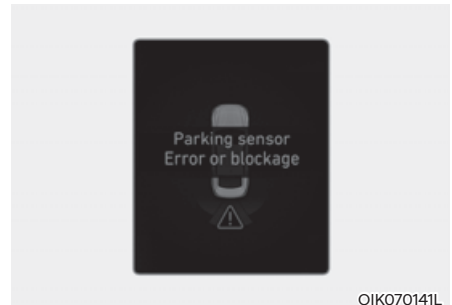

OIK070141L



 **WARNING**

- **Reverse Parking Distance Warning is a supplemental function. The operation of Reverse Parking Distance Warning can be affected by several factors (including environmental conditions). It is the responsibility of the driver to always check the rear view before and while parking.**
- **Your new vehicle warranty does not cover any accidents or damage to the vehicle due to the malfunction of Reverse Parking Distance Warning.**
- **Pay close attention when driving near objects, pedestrians, and especially children. Some objects may not be detected by the ultrasonic sensors, due to the objects distance, size or material, all of which can limit the effectiveness of the sensor.**

***Limitations of Reverse Parking Distance Warning***

- Reverse Parking Distance Warning may not operate normally when:
  - Moisture is frozen to the sensor
  - Sensor is covered with foreign material, such as snow or water (Reverse Parking Distance Warning will operate normally when such foreign material are removed.)
  - The weather is extremely hot or cold
  - The sensor or sensor assembly is disassembled
  - The surface of the sensor is pressed hard or an impact is applied with a hard object
  - The surface of the sensor is scratched with a sharp object
  - The sensors or its surrounding area is directly sprayed with high pressure washer
- Reverse Parking Distance Warning may malfunction when:
  - Heavy rain or water spray is present
  - Water flows on the surface of the sensor
  - Affected by another vehicle's sensors
  - The sensor is covered with snow
  - Driving on uneven road, gravel roads or bushes
  - Objects that generates ultrasonic waves are near the sensor
  - Installing the license plate differently from the original location
  - The vehicle bumper height or ultrasonic sensor installation has been modified
  - Attaching equipments or accessories around the ultrasonic sensors
- The following objects may not be detected:
  - Sharp or slim objects, such as ropes, chains or small poles.
  - Objects, which tend to absorb sensor frequency, such as clothes, spongy material or snow.
  - Objects smaller than 40 in. (100 cm) in length and narrower than 6 in. (14 cm) in diameter.
  - Pedestrians, animals or objects that are very close to the ultrasonic sensors
- Parking Distance Warning Indicators may be displayed differently from the actual detected location when the obstacle is located between the sensors.
- Parking Distance Warning indicator may not occur sequentially depending on vehicle speed or obstacle shape.
- If Reverse Parking Distance Warning needs repair, have the vehicle inspected by an authorized retailer of Genesis Branded products.

## FORWARD/REVERSE PARKING DISTANCE WARNING (PDW) (IF EQUIPPED)

Forward/Reverse Parking Distance Warning will help warn the driver if an obstacle is detected within a certain distance when the vehicle is moving forward or in reverse at low speeds.

### **Detecting sensor**

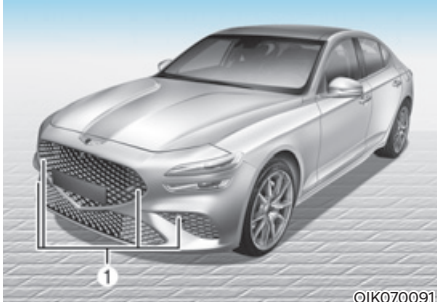

©IK070091

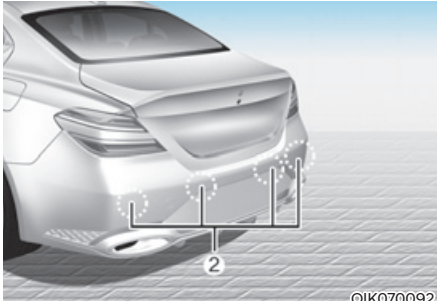

©IK070092

[1] : Front ultrasonic sensors,

[2] : Rear ultrasonic sensors

Refer to the picture above for the detailed location of the detecting sensors.

### Forward/Reverse Parking Distance Warning Settings

#### **Warning Volume**

With the engine on, ON position, select 'Driver Assistance → Warning Volume' from the Settings menu to change the Warning Volume to 'High', 'Medium', 'Low' or 'Off' for Forward/ Reverse Parking Distance Warning.

However, even if 'Off' is selected, Warning Volume of Forward/Reverse Parking Distance Warning will not turn off but the volume will sound as 'Low'.

If you change the Warning Volume, the Warning Volume of other Driver Assistance systems may change.

#### **Parking Distance Warning Auto On**

To use Parking Distance Warning Auto On function, select 'Driver Assistance → Parking Safety → Parking Distance Warning Auto On' from the infotainment system Settings menu.

## Forward/Reverse Parking Distance Warning Operation

### Operating button





### Parking Safety button

- Press the Parking Safety (P) button to turn on Forward/Reverse Parking Distance Warning. Press the button again to turn off the function.
- When Forward/Reverse Parking Distance Warning is off (button indicator light off), if you shift the gear to R (Reverse), Forward/Reverse Parking Distance Warning will automatically turn on.
- When Forward/Reverse Parking Distance Warning turns on, the button indicator light will turn on. If the vehicle speed is above 18 mph (30 km/h), Forward/Reverse Parking Distance Warning will turn off (button indicator light off).

### Forward Parking Distance Warning

- Forward Parking Distance Warning will operate when one of the condition is satisfied.
  - The gear is shifted from R (Reverse) to D (Drive) with Reverse Parking Distance Warning on
  - The gear is in D (Drive) and the Parking Safety button indicator light is on
  - 'Parking Distance Warning Auto On' is selected from the Settings menu and the gear is in D (Drive)
- Forward Parking Distance Warning may detect a person, animal or object in front when the vehicle's forward speed is below 6 mph (10 km/h).
- Forward Parking Distance Warning does not operate when the vehicle's forward speed is above 6 mph (10 km/h) even when the Parking Safety button indicator is on. Forward Parking Distance Warning will operate again when the vehicle's forward speed decreases below 6 mph (10 km/h) while the Parking Safety button indicator is on.
- When 'Parking Distance Warning Auto On' is selected, the Parking Safety button indicator light stays on.



- When 'Parking Distance Warning Auto On' is deselected, and the vehicle's forward speed is above 12 mph (20 km/h), the Parking Safety button indicator will turn off. Although you drive below 6 mph (10 km/h), the system will not turn on.

Distance from object	Warning indicator	Warning sound
	Driving forward	
24-40 in. (60-100 cm)		Buzzer beeps intermittently
12-24 in. (30-60 cm)		Beeps more frequently
12 in. (within 30 cm)		Beeps continuously

- The corresponding indicator will illuminate whenever each ultrasonic sensor detects a person, animal or object in its sensing range. Also an audible warning will sound.
- When more than two objects are detected at the same time, the closest one will be warned with an audible warning.
- The shape of the indicator in the illustration may differ from the actual vehicle.

### Reverse Parking Distance Warning

- Reverse Parking Distance Warning will operate when the gear is in R (Reverse).
- Reverse Parking Distance Warning helps detect a person, animal or object in the rear when the vehicle's rearward speed is below 6 mph (10 km/h).
- When the vehicle's rearward speed is below 6 mph (10 km/h), both the front and rear ultrasonic sensors will help detect objects. However, the front ultrasonic sensors can help detect a person, animal or object when it is within 24 in. (60 cm) from the sensors.

Distance from object	Warning indicator	Warning sound
	Driving rearward	
24-48 in. (60-120 cm)		Buzzer beeps intermittently
12-24 in. (30-60 cm)		Beeps more frequently
12 in. (within 30 cm)		Beeps continuously

- The corresponding indicator will illuminate whenever each ultrasonic sensor detects a person, animal or object in its sensing range. Also an audible warning will sound.
- When more than two objects are detected at the same time, the closest one will be warned with an audible warning.
- The shape of the indicator in the illustration may differ from the actual vehicle.

## Forward/Reverse Parking Distance Warning Malfunction and Precautions

### **Forward/Reverse Parking Distance Warning malfunction**

After starting the engine, a beep will sound when the gear is shifted to R (Reverse) to indicate Forward/Reverse Parking Distance Warning is operating normally.

However, if one or more of the following occurs, first check whether the ultrasonic sensor is damaged or blocked with foreign material. If it still does not work properly, have the vehicle inspected by an authorized retailer of Genesis Branded products.

- The audible warning does not sound.
- The buzzer sounds intermittently.
- The 'Parking sensor error or blockage' warning message appears on the cluster.



### **WARNING**

- **Forward/Reverse Parking Distance Warning is a supplemental function. The operation of Forward/Reverse Parking Distance Warning can be affected by several factors (including environmental conditions). It is the responsibility of the driver to always check the front and rear views before and while parking.**
- **Your new vehicle warranty does not cover any accidents or damage to the vehicle due to the malfunction of Forward/Reverse Parking Distance Warning.**
- **Pay close attention when driving near objects, pedestrians, and especially children. Some objects may not be detected by the ultrasonic sensors, due to the objects distance, size or material, all of which can limit the effectiveness of the sensor.**

### **Limitations of Forward/Reverse Parking Distance Warning**

- Forward/Reverse Parking Distance Warning may not operate normally when:
  - Moisture is frozen to the sensor
  - Sensor is covered with foreign material, such as snow or water (Forward/Reverse Parking Distance Warning will operate normally when such foreign material are removed.)
  - The weather is extremely hot or cold
  - The sensor or sensor assembly is disassembled
  - The surface of the sensor is pressed hard or an impact is applied with a hard object
  - The surface of the sensor is scratched with a sharp object
  - The sensors or its surrounding area is directly sprayed with high pressure washer
- Forward/Reverse Parking Distance Warning may malfunction when:
  - Heavy rain or water spray is present
  - Water flows on the surface of the sensor
  - Affected by another vehicle's sensors
  - The sensor is covered with snow
  - Driving on uneven road, gravel roads or bushes
  - Objects that generates ultrasonic waves are near the sensor
  - Installing the license plate differently from the original location
  - The vehicle bumper height or ultrasonic sensor installation has been modified
  - Attaching equipments or accessories around the ultrasonic sensors
- The following objects may not be detected:
  - Sharp or slim objects, such as ropes, chains or small poles.
  - Objects, which tend to absorb sensor frequency, such as clothes, spongy material or snow.
  - Objects smaller than 40 in. (100 cm) in length and narrower than 6 in. (14 cm) in diameter.
  - Pedestrians, animals or objects that are very close to the ultrasonic sensors
- Parking Distance Warning Indicators may be displayed differently from the actual detected location when the obstacle is located between the sensors.
- Parking Distance Warning indicator may not occur sequentially depending on vehicle speed or obstacle shape.
- If Forward/Reverse Parking Distance Warning needs repair, have the vehicle inspected by an authorized retailer of Genesis Branded products.

## DECLARATION OF CONFORMITY (IF EQUIPPED)

The radio frequency components complies:

### Front Radar

#### ■ For USA



#### FCC ID

: 2ACDX-LRR-20

This device complies with Part 15 of the FCC Rules. Operation is subject to the following two conditions:

- (1) this device may not cause harmful interference, and
- (2) this device must accept any interference received, including interference that may cause undesired operation.

#### CAUTION TO USERS

Changes or modifications not expressly approved by the party responsible for compliance could void the user's authority to operate the equipment.

OANATEL125

#### ■ For Canada

Model: LRR-20  
IC: 11988A-LRR20

This device complies with Industry Canada licence-exempt RSS standard(s). Operation is subject to the following two conditions:

- (1) this device may not cause interference, and
- (2) this device must accept any interference, including interference that may cause undesired operation of the device.

Le présent appareil est conforme aux CNR

d'Industrie Canada applicables aux appareils radio exempts de licence. L'exploitation est autorisée

aux deux conditions suivantes:

- (1) l'appareil ne doit pas produire de brouillage, et
- (2) l'utilisateur de l'appareil doit accepter tout brouillage radioélectrique subi, même si le brouillage est susceptible d'en compromettre le fonctionnement.

OANATEL126

## Rear Corner Radar

### ■ For USA



UR8 303919

This device complies with Part 15 of the FCC Rules. Operation is subject to the following two conditions:

- (1) this device may not cause harmful interference, and
- (2) this device must accept any interference received, including interference that may cause undesired operation.

#### CAUTION TO USERS

Changes or modifications not expressly approved by the party responsible for compliance could void the user's authority to operate the equipment.

OANATEL024

### ■ For Canada

This Category II radiocommunication device complies with Industry Canada Standard RSS-310.  
Ce dispositif de radiocommunication de catégorie II respecte la norme CNR-310 d'Industrie Canada .

This device complies with Industry Canada licence-exempt RSS standard(s). Operation is subject to the following two conditions:

- (1) this device may not cause interference, and (2) this device must accept any interference, including interference that may cause undesired operation of the device.

Le présent appareil est conforme aux CNR d'Industrie Canada applicables aux appareils radio exempts de licence.

L'exploitation est autorisée aux deux conditions suivantes :

- (1) l'appareil ne doit pas produire de brouillage, et (2) l'utilisateur de l'appareil doit accepter tout brouillage radioélectrique subi, même si le brouillage est susceptible d'en compromettre le fonctionnement.

OHCR079068L



# 8. Emergency Situations

Hazard Warning Flasher .....	8-2
In Case of an Emergency while Driving.....	8-2
If the Engine Stalls While Driving.....	8-2
If the Engine Stalls at a Crossroad or Crossing .....	8-2
If You Have a Flat Tire While Driving.....	8-3
If the Engine will not Start.....	8-3
Jump Starting .....	8-4
If the Engine Overheats.....	8-7
Tire Pressure Monitoring System (TPMS).....	8-8
Check Tire Pressure.....	8-8
Tire Pressure Monitoring System .....	8-9
Low Tire Pressure Warning Light.....	8-10
Low Tire Pressure Position and Tire Pressure Telltale.....	8-10
TPMS (Tire Pressure Monitoring System) Malfunction Indicator.....	8-11
Changing a Tire with TPMS .....	8-11
If you have a Flat Tire (with Spare Tire) .....	8-13
Jack and Tools .....	8-13
Changing Tires.....	8-14
Jack Label.....	8-18
If you have a flat tire (with Tire Mobility Kit) .....	8-19
Introduction.....	8-19
Notes on the Safe use of the Tire Mobility Kit.....	8-20
Components of the Tire Mobility Kit .....	8-21
Using the Tire Mobility Kit When a Tire is Flat.....	8-22
How to Adjust Tire Pressure .....	8-25
Towing .....	8-26
Towing Service .....	8-26
Removable Towing Hook.....	8-27
Emergency Towing.....	8-28

## HAZARD WARNING FLASHER

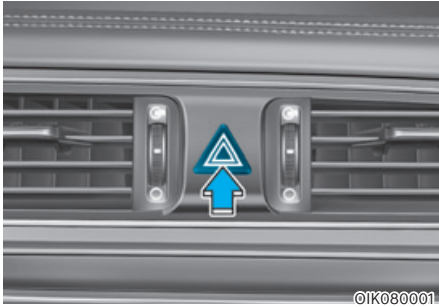

The hazard warning flasher serves as a warning to other drivers to exercise extreme caution when approaching, overtaking, or passing your vehicle.

It should be used whenever emergency repairs are being made or when the vehicle is stopped near the edge of a roadway.

To turn the hazard warning flasher on or off, press the hazard warning flasher button with the Engine Start/Stop button in any position. The hazard warning flasher button is located in the center fascia panel. All turn signal lights will flash simultaneously.

- The hazard warning flasher operates regardless of whether your vehicle is running or not.
- The turn signals do not work when the hazard flasher is on.

## IN CASE OF AN EMERGENCY WHILE DRIVING

### If the Engine Stalls While Driving

- Reduce your speed gradually, keeping a straight line. Move cautiously off the road to a safe place.
- Turn on your hazard warning flasher.
- Try to start the engine again. If your vehicle will not start, we recommend that you contact an authorized retailer of Genesis Branded products or seek other qualified assistance.

### If the Engine Stalls at a Crossroad or Crossing

If the engine stalls at a crossroads or crossing, if safe to do so, shift the gear to N (Neutral) and then push the vehicle to a safe location.

## If You Have a Flat Tire While Driving

If a tire goes flat while you are driving:

- Take your foot off the accelerator pedal and let the vehicle slow down while driving straight ahead. Do not apply the brakes immediately or attempt to pull off the road as this may cause loss of vehicle control resulting in an accident. When the vehicle has slowed to such a speed that it is safe to do so, brake carefully and pull off the road. Drive off the road as far as possible and park on firm, level ground. If you are on a divided highway, do not park in the median area between the two traffic lanes.
- When the vehicle is stopped, press the hazard warning flasher button, shift the vehicle to P (Park), apply the parking brake, and press the Engine Start/Stop button to the OFF position.
- Have all passengers get out of the vehicle. Be sure they all get out on the side of the vehicle that is away from traffic.
- When changing a flat tire, follow the instructions provided later in this chapter.

## IF THE ENGINE WILL NOT START

- Be sure to shift the vehicle to P (Park) if it is an automatic transmission vehicle. The engine starts only when the vehicle is in P (Park).
- Turn on the interior light. If the light dims or goes out when you operate the starter, the battery is drained.  
**See instructions for “Jump Starting” provided in this chapter.**
- Check the fuel level and add fuel if necessary.

If the vehicle still does not start, call an authorized retailer of Genesis Branded products for assistance.

### **NOTICE**

**Push or pull starting the vehicle may cause the catalytic converter to overload which can lead to damage to the emission control system.**

## JUMP STARTING

Jump starting can be dangerous if done incorrectly. Follow the jump starting procedure in this section to avoid serious injury or damage to your vehicle. If in doubt about how to properly jump start your vehicle, we strongly recommend that you have a service technician or towing service do it for you.



### WARNING

To prevent **SERIOUS INJURY** or **DEATH** to you or bystanders, always follow these precautions when working near or handling the battery:



Always read and follow instructions carefully when handling a battery.



Wear eye protection designed to protect the eyes from acid splashes.



Keep all flames, sparks, or smoking materials away from the battery.



Hydrogen is always present in battery cells, is highly combustible, and may explode if ignited.



Keep batteries out of reach of children.



Batteries contain sulfuric acid which is highly corrosive. Do not allow acid to contact your eyes, skin or clothing.

If acid gets into your eyes, flush your eyes with clean water for at least 15 minutes and get immediate medical attention. If acid gets on your skin, thoroughly wash the area. If you feel pain or a burning sensation, get medical attention immediately.

- When lifting a plastic-cased battery, excessive pressure on the case may cause battery acid to leak. Lift with a battery carrier or with your hands on opposite corners.
- Do not attempt to jump start your vehicle if your battery is frozen.
- NEVER attempt to recharge the battery when the vehicle's battery cables are connected to the battery.
- The electrical ignition system works with high voltage.

NEVER touch these components with the engine running or when the Engine Start/Stop button is in the ON position.

## Jump starting procedure

### **i** Information

Your vehicle has a battery in the luggage compartment, but when you jump start your vehicle, use the jumper terminal in the engine compartment.

1. Position the vehicles close enough that the jumper cables will reach, but do not allow the vehicles to touch.
2. Avoid fans or any moving parts in the engine compartment at all times, even when the vehicles are turned off.
3. Turn off all electrical devices such as radios, lights, air conditioning, etc. Put the vehicles in P (Park), and apply the parking brake. Turn both vehicles OFF.
4. Open the engine hood.
5. Remove the engine compartment fuse box cover.

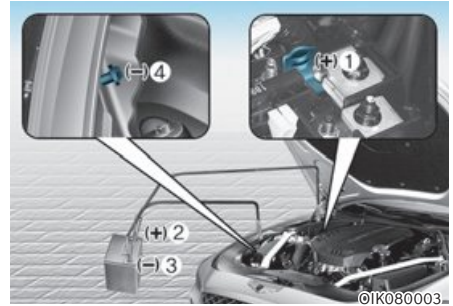

6. Connect the jumper cables in the exact sequence shown in the illustration. First connect one jumper cable to the red, positive (+) jumper terminal of your vehicle (1).
7. Connect the other end of the jumper cable to the red, positive (+) battery/ jumper terminal of the assisting vehicle (2).
8. Connect the second jumper cable to the black, negative (-) battery/ chassis ground of the assisting vehicle (3).
9. Connect the other end of the second jumper cable to the black, negative (-) chassis ground of your vehicle (4).

Do not allow the jumper cables to contact anything except the correct battery or jumper terminals or the correct ground. Do not lean over the battery when making connections.

10. Start the engine of the assisting vehicle and let it run at approximately 2,000 RPM for a few minutes. Then start your vehicle.
11. Keep your vehicle operating for at least 30 minutes at idle or driving to assure your battery receives enough charge to be able to start on its own after the vehicle is shut off. A complete dead battery may require as long as 60 minutes runtime to fully recharge it. If vehicle is run for less, the battery may not restart.

If your vehicle will not start after a few attempts, it probably, requires servicing. In this event please seek qualified assistance. If the cause of your battery discharging is not apparent, have your vehicle checked by an authorized retailer of Genesis Branded products.

Disconnect the jumper cables in the exact reverse order you connected them:

1. Disconnect the jumper cable from the black, negative (-) chassis ground of your vehicle (4).
2. Disconnect the other end of the jumper cable from the black, negative (-) battery/chassis ground of the assisting vehicle (3).
3. Disconnect the second jumper cable from the red, positive (+) battery/jumper terminal of the assisting vehicle (2).
4. Disconnect the other end of the jumper cable from the red, positive (+) jumper terminal of your vehicle (1).

### Information



**An inappropriately disposed battery can be harmful to the environment and human health. Dispose of the battery according to your local law(s) or regulations.**

### **NOTICE**

**To prevent damage to your vehicle:**

- **Only use a 12-volt power supply (battery or jumper system) to jump start your vehicle.**
- **Do not attempt to jump start your vehicle by push-starting.**

## IF THE ENGINE OVERHEATS

If your temperature gauge indicates overheating, you experience a loss of power, or hear loud pinging or knocking, the engine may be overheating. If this happens, you should:

1. Pull off the road and stop as soon as it is safe to do so.
2. Shift the vehicle to P (Park), and apply the parking brake. If the air conditioning is ON, turn it OFF.
3. If engine coolant is running out under the vehicle or steam is coming out from the hood, stop the engine. Do not open the hood until the coolant has stopped running or the steaming has stopped. If there is no visible loss of engine coolant and no steam, leave the engine running and check to be sure the engine cooling fan is operating. If the fan is not running, turn the engine off.



### WARNING



**While the engine is running, keep hands, clothing and tools away from the moving parts such as the cooling fan and drive belt to prevent serious injury.**



4. Check for coolant leaking from the radiator, hoses or under the vehicle. (If the air conditioning had been in use, it is normal for cold water to be draining from it when you stop.)
5. If engine coolant is leaking out, stop the engine immediately and call the nearest authorized retailer of Genesis Branded products for assistance.



### WARNING



**Never remove the radiator cap, coolant cap or the drain plug while the engine and radiator are hot.**

**Hot coolant and steam may blow out under pressure, causing serious injury.**

**Turn the engine off and wait until the engine cools down. Use extreme care when removing the radiant cap or coolant cap. Wrap a thick towel around it, and turn it counterclockwise slowly to the first stop. Step back while the pressure is released from the cooling system. When you are sure all the pressure has been released, press down on the cap, using a thick towel, and continue turning counterclockwise to remove it.**

6. If you cannot find the cause of the overheating, wait until the engine temperature has returned to normal. Then, if coolant has been lost, carefully add coolant to the reservoir to bring the fluid level in the reservoir up to the halfway mark.
7. Proceed with caution, keeping alert for further signs of overheating. If overheating happens again, call an authorized retailer of Genesis Branded products for assistance.



### CAUTION

- **Serious loss of coolant indicates a leak in the cooling system and should be checked as soon as possible by an authorized retailer of Genesis Branded products.**
- **When the engine overheats from low engine coolant, suddenly adding engine coolant may cause cracks in the engine. To prevent damage, add engine coolant slowly in small quantities. It may require several refilling cycles to properly fill the engine cooling system. If necessary, an authorized retailer of Genesis Branded products should be consulted to perform this task.**

## TIRE PRESSURE MONITORING SYSTEM (TPMS)



OIK080004L



OIK080005L

- (1) Low Tire Pressure Telltale/TPMS Malfunction Indicator
- (2) Low Tire Pressure Position Telltale and Tire Pressure Telltale (Shown on the LCD display)

### Check Tire Pressure



OIK080023L

- You can check the tire pressure in the on the cluster.  
**Refer to the “LCD display” section in chapter 4.**
  - Tire pressure is displayed after a few minutes of driving after initial vehicle start up.
  - If tire pressure is not displayed when the vehicle is stopped, ‘Drive to display’ message will appear. After driving, check the tire pressure.
  - The displayed tire pressure values may differ from those measured with a tire pressure gauge.
  - You can change the tire pressure unit from the Settings menu in the infotainment system screen. Select:
    - Setup → General Settings → Unit → Tire Air Pressure Unit → psi/kPa/bar
- For detailed information, refer to the separately supplied manual.**



## Tire Pressure Monitoring System



### WARNING

**Over-inflation or under-inflation can reduce tire life, adversely affect vehicle handling, and lead to sudden tire failure that may cause loss of vehicle control resulting in an accident.**

Each tire, including the spare (if provided), should be checked monthly when cold and inflated to the inflation pressure recommended by the vehicle manufacturer on the vehicle placard or tire inflation pressure label. (If your vehicle has tires of a different size than the size indicated on the vehicle placard or tire inflation pressure label, you should determine the proper tire inflation pressure for those tires.)

As an added safety feature, your vehicle has been equipped with a tire pressure monitoring system (TPMS) that illuminates a low tire pressure telltale when one or more of your tires is significantly under-inflated. Accordingly, when the low tire pressure telltale illuminates, you should stop and check your tires as soon as possible, and inflate them to the proper pressure. Driving on a significantly under-inflated tire causes the tire to overheat and can lead to tire failure.

Under-inflation also reduces fuel efficiency and tire tread life, and may affect the vehicle's handling and stopping ability.

Please note that the TPMS is not a substitute for proper tire maintenance, and it is the driver's responsibility to maintain correct tire pressure, even if under-inflation has not reached the level to trigger illumination of the TPMS low tire pressure telltale.

Your vehicle has also been equipped with a TPMS malfunction indicator to indicate when the system is not operating properly. The TPMS malfunction indicator is combined with the low tire pressure telltale. When the system detects a malfunction, the telltale will flash for approximately one minute and then remain continuously illuminated. This sequence will continue upon subsequent vehicle start-ups as long as the malfunction exists.

When the malfunction indicator is illuminated, the system may not be able to detect or signal low tire pressure as intended. TPMS malfunctions may occur for a variety of reasons, including the installation of replacement or alternate tires or wheels on the vehicle that prevent the TPMS from functioning properly.

Always check the TPMS malfunction telltale after replacing one or more tires or wheels on your vehicle to ensure that the replacement or alternate tires and wheels allow the TPMS to continue to function properly.

### NOTICE

**If any of the below happens, have the system checked by an authorized retailer of Genesis Branded products.**

- 1. The Low Tire Pressure Telltale/ TPMS Malfunction Indicator does not illuminate for 3 seconds when the Engine Start/Stop button is pressed to the ON position or when the engine is running.**
- 2. The TPMS Malfunction Indicator remains illuminated after blinking for approximately 1 minute.**
- 3. The Low Tire Pressure Position Telltale remains illuminated.**



## Low Tire Pressure Warning Light

### Low Tire Pressure Position and Tire Pressure Telltale



When the tire pressure monitoring system warning indicators illuminate and the warning message displayed on the cluster LCD display, one or more of your tires is significantly under-inflated. The Low Tire Pressure Position Telltale will indicate which tire is significantly underinflated by illuminating the corresponding position light.

If either telltale illuminates, immediately reduce your speed, avoid hard cornering and anticipate increased stopping distances. You should stop and check your tires as soon as possible. Inflate the tires to the proper pressure as indicated on the vehicle's placard or tire inflation pressure label located on the driver's side center pillar outer panel.

If you cannot reach a service station or if the tire cannot hold the newly added air, replace the low pressure tire with the spare tire.

The Low Tire Pressure LCD position indicator will remain on and the TPMS Malfunction Indicator may blink for one minute and then remain illuminated until you have the low pressure tire repaired and replaced on the vehicle.



### CAUTION

**In winter or cold weather, the Low Tire Pressure Telltale may be illuminated if the tire pressure was adjusted to the recommended tire inflation pressure in warm weather. It does not mean your TPMS is malfunctioning because the decreased temperature may lead to a proportional lowering of tire pressure.**

**When you drive your vehicle from a warm area to a cold area or from a cold area to a warm area, or the outside temperature is greatly higher or lower, you should check the tire inflation pressure and adjust the tires to the recommended tire inflation pressure.**



### WARNING

#### Low pressure damage

**Significantly low tire pressure makes the vehicle unstable and can contribute to loss of vehicle control and increased braking distances.**

**Continued driving on low pressure tires can cause the tires to overheat and fail.**



## TPMS (Tire Pressure Monitoring System) Malfunction Indicator

The TPMS Malfunction Indicator will illuminate after it blinks for approximately one minute when there is a problem with the Tire Pressure Monitoring System.

Have the system checked by an authorized retailer of Genesis Branded products as soon as possible.

### NOTICE

**If there is a malfunction with the TPMS, the Low Tire Pressure Position Telltale will not be displayed even though the vehicle has an under-inflated tire.**

### NOTICE

**The TPMS Malfunction Indicator may illuminate after blinking for one minute if the vehicle is near electric power supply cables or radio transmitters such as police stations, government and public offices, broadcasting stations, military installations, airports, transmitting towers, etc.**

**Additionally, the TPMS Malfunction Indicator may illuminate if snow chains are used or electronic devices such as computers, chargers, remote starters, navigation, etc. This may interfere with normal operation of the TPMS.**

## Changing a Tire with TPMS

If you have a flat tire, the Low Tire Pressure and Position telltales will come on. Have the flat tire repaired by an authorized retailer of Genesis Branded products as soon as possible or replace the flat tire with the spare tire.

### NOTICE

**It is recommended that you do not use a puncture-repairing agent not approved by an authorized retailer of Genesis Branded products to repair and/or inflate a low pressure tire. Tire sealant not approved by an authorized retailer of Genesis Branded products may damage the tire pressure sensor.**

The spare tire does not come with a tire pressure monitoring sensor. When the low pressure tire or the flat tire is replaced with the spare tire, the Low Tire Pressure LCD position indicator will remain on. Also, the TPMS Malfunction Indicator will illuminate after blinking for one minute if the vehicle is driven at speed above 15.5 mph (25 km/h) for approximately 20 minutes.

Once the original wheel equipped with a tire pressure monitoring sensor is reinflated to the recommended pressure and reinstalled on the vehicle, the Low Tire Pressure Telltale and TPMS Malfunction Indicator will go off within a few minutes of driving.

If the indicators do not extinguish after a few minutes, please visit an authorized retailer of Genesis Branded products.

Each wheel is equipped with a tire pressure sensor mounted inside the tire behind the valve stem (except for the spare tire). You must use TPMS specific wheels. It is recommended that you always have your tires serviced by an authorized retailer of Genesis Branded products.

You may not be able to identify a tire with low pressure by simply looking at it. Always use a good quality tire pressure gauge to measure. Please note that a tire that is hot (from being driven) will have a higher pressure measurement than a tire that is cold.

A cold tire means the vehicle has been sitting for 3 hours and driven for less than 1 mile (1.6 km) in that 3 hour period.

Allow the tire to cool before measuring the inflation pressure. Always be sure the tire is cold before inflating to the recommended pressure.



### WARNING

- **The TPMS cannot alert you to severe and sudden tire damage caused by external factors such as nails or road debris.**
- **If you feel any vehicle instability, immediately take your foot off the accelerator, apply the brakes gradually with light force, and slowly move to a safe position off the road.**



### WARNING

**Tampering with, modifying, or disabling the Tire Pressure Monitoring System (TPMS) components may interfere with the system's ability to warn the driver of low tire pressure conditions and/or TPMS malfunctions. Tampering with, modifying, or disabling the Tire Pressure Monitoring System (TPMS) components may void the warranty for that portion of the vehicle.**



### WARNING

**This device complies with Part 15 of the FCC rules.**

**Operation is subject to the following three conditions:**

1. This device may not cause harmful interference.
2. This device must accept any interference received, including interference that may cause undesired operation.
3. Changes or modifications not expressly approved by the party responsible for compliance could void the user's authority to operate the equipment.

## IF YOU HAVE A FLAT TIRE (WITH SPARE TIRE, IF EQUIPPED)



### WARNING

Changing a tire can be dangerous. Follow the instructions in this section when changing a tire to reduce the risk of serious injury or death.



### CAUTION

Be careful as you use the jack handle to stay clear of the flat end. The flat end has sharp edges that could cause cuts.

### Jack and Tools

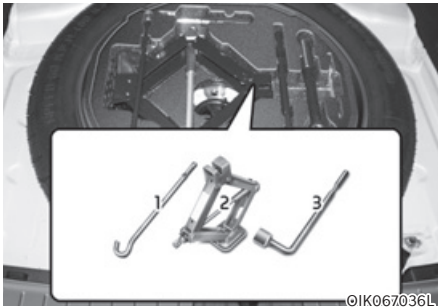

- (1) Jack handle
- (2) Jack
- (3) Wheel nut wrench

The jack, jack handle, and wheel nut wrench are stored in the luggage compartment under the luggage box cover.

The jack is provided for emergency tire changing only.



Turn the winged hold down bolt counterclockwise to remove the spare tire.

Store the spare tire in the same compartment by turning the winged hold down bolt clockwise.

To prevent the spare tire and tools from “rattling”, store them in their proper location.



If it is hard to loosen the tire hold-down wing bolt by hand, you can loosen it easily using the jack handle.

1. Put the jack handle (1) inside of the tire hold-down wing bolt.
2. Turn the tire hold-down wing bolt counterclockwise with the jack handle.



### WARNING



Do not touch luggage room metal surface while the engine is operating or hot.

Doing so could result in serious personal injury.

Turn the engine off and wait until it cools down or wear gloves to remove the spare tire from the luggage room.

## Changing Tires



### WARNING

A vehicle can slip or roll off of a jack causing serious injury or death to you or those nearby. Take the following safety precautions:

- Do not get under a vehicle that is supported by a jack.
- NEVER attempt to change a tire in the lane of traffic. ALWAYS move the vehicle completely off the road on level, firm ground away from traffic before trying to change a tire. If you cannot find a level, firm place off the road, call a towing service for assistance.
- Be sure to use the jack provided with the vehicle.
- ALWAYS place the jack on the designated jacking positions on the vehicle and NEVER on the bumpers or any other part of the vehicle for jacking support.
- Do not start or run the engine while the vehicle is on the jack.
- Do not allow anyone to remain in the vehicle while it is on the jack.
- Keep children away from the road and the vehicle.

Follow these steps to change your vehicle's tire:

1. Park on a level, firm surface.
2. Shift the vehicle to P (Park), apply the parking brake, and press the Engine Start/Stop button to the OFF position.
3. Press the hazard warning flasher button.
4. Remove the wheel lug wrench, jack, jack handle, and spare tire from the vehicle.



[A]: Block

5. Block both the front and rear of the tire diagonally opposite of the tire you are changing.



OIK067034L

6. Loosen the lug nuts counterclockwise one turn each in the order shown above, but do not remove any lug nuts until the tire has been raised off of the ground.



OIK080031L

8. Insert the jack handle into the jack and turn it clockwise, raising the vehicle until the tire clears the ground. Make sure the vehicle is stable on the jack.

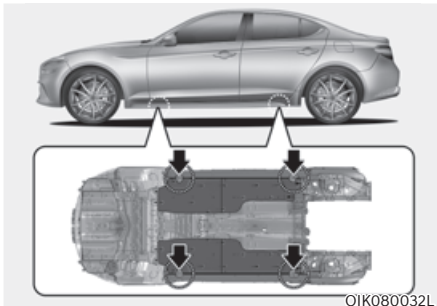

OIK080032L

7. Place the jack at the designated jacking position under the frame closest to the tire you are changing. The jacking positions are plates welded to the frame with two notches. Never jack at any other position or part of the vehicle. Doing so may damage the side seal molding or other parts of the vehicle.

9. Loosen the lug nuts with the wheel lug nut wrench and remove them with your fingers. Remove the wheel from the studs and lay it flat on the ground out of the way. Remove any dirt or debris from the studs, mounting surfaces, and wheel.
10. Install the spare tire onto the studs of the hub.
11. Tighten the lug nuts with your fingers onto the studs with the smaller end of the lug nuts closest to the wheel.
12. Lower the vehicle to the ground by turning the jack handle counterclockwise.

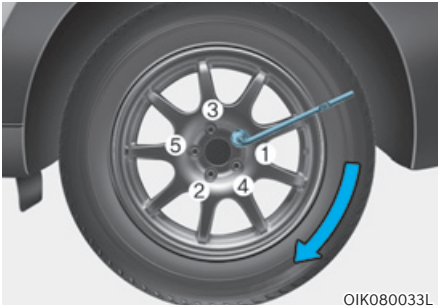

13. Use the wheel lug nut wrench to tighten the lug nuts in the order shown. Double-check each lug nut until they are tight. After changing tires, we recommend that an authorized retailer of Genesis Branded products tighten the lug nuts to their proper torque as soon as possible. **The wheel lug nut should be tightened to 11–13 kgf·m (79~94 lbf·ft).**

If you have a tire gauge, check the tire pressure (see “Tires and Wheels” section in chapter 2 for tire pressure instructions.). If the pressure is lower or higher than recommended, drive slowly to the nearest service station and adjust it to the recommended pressure. Always reinstall the valve cap after checking or adjusting tire pressure. If the cap is not replaced, air may leak from the tire. If you lose a valve cap, buy another and install it as soon as possible. After changing tires, secure the flat tire and return the jack and tools to their proper storage locations.

### NOTICE

- Check the tire pressure as soon as possible after installing a spare tire. Adjust it to the recommended pressure.
- Check and tighten the wheel lug nuts after driving over 30 miles (50 km) if tires are replaced. Recheck the tire wheel lug nuts after driving over 600 miles (1,000 km).



### CAUTION

**Your vehicle has metric threads on the studs and lug nuts. Make certain during tire changing that the same nuts that were removed are reinstalled. If you have to replace your lug nuts make sure they have metric threads to avoid damaging the studs and ensure the wheel is properly secured to the hub. Consult an authorized retailer of Genesis Branded products for assistance.**

If any of the equipment such as the jack, lug nuts, studs, or other equipment is damaged or in poor condition, do not attempt to change the tire and call for assistance.

### *Use of compact spare tires*

Compact spare tires are designed for emergency use only. Drive carefully on the compact spare tire and always follow the safety precautions.



**WARNING**

To prevent compact spare tire failure and loss of control possibly resulting in an accident:

- Use the compact spare tire only in an emergency.
- **NEVER** operate your vehicle over 50 mph (80 km/h).
- Do not exceed the vehicle's maximum load rating or the load carrying capacity shown on the sidewall of the compact spare tire.
- Do not use the compact spare tire continuously. Repair or replace the original tire as soon as possible to avoid failure of the compact spare tire.

When driving with the compact spare tire mounted to your vehicle:

- Check the tire pressure after installing the compact spare tire. The compact spare tire should be inflated to 60 psi (420 kPa).
- Do not take this vehicle through an automatic car wash while the compact spare tire is installed.
- Do not use the compact spare tire on any other vehicle because this tire has been designed especially for your vehicle.
- The compact spare tire's tread life is shorter than a regular tire. Inspect your compact spare tire regularly and replace worn compact spare tires with the same size and design, mounted on the same wheel.
- Do not use more than one compact spare tire at a time.

**Information**

When the original tire and wheel are repaired and reinstalled on the vehicle, the wheel lug nuts torque must be set correctly. The correct wheel lug nuts tightening torque is 79~94 lbf·ft (11~13 kgf·m ).

**NOTICE**

To prevent damaging the compact spare tire and your vehicle:

- Drive slowly enough for the road conditions to avoid all hazards, such as a potholes or debris.
- Avoid driving over obstacles. The compact spare tire diameter is smaller than the diameter of a conventional tire and reduces the ground clearance approximately 1 in. (25 mm).
- Do not use tire chains on the compact spare tire. Because of the smaller size, a tire chain will not fit properly.
- Do not use the compact spare tire on any other wheels, nor should standard tires, snow tires, wheel covers or trim rings be used with the compact spare wheel.

## Jack Label

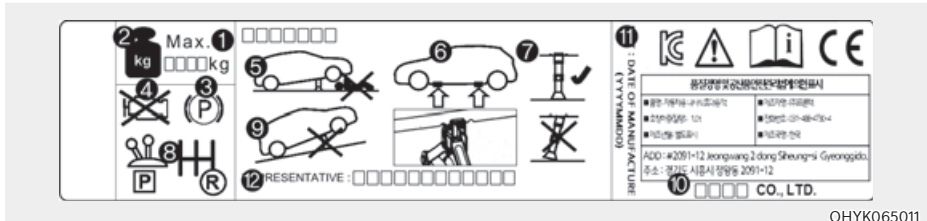

OHYK065011

The actual Jack label in the vehicle may differ from the illustration.

For more detailed specifications, refer to the label attached to the jack.

1. Model Name
2. Maximum allowable load
3. When using the jack, set your parking brake.
4. When using the jack, stop the engine.
5. Do not get under a vehicle that is supported by a jack.
6. The designated locations under the frame
7. When supporting the vehicle, the base plate of jack must be vertical under the lifting point.
8. Shift into Reverse gear on vehicles with manual transmission or shift the gear to the P position on vehicles with automatic transmission.
9. The jack should be used on firm level ground.
10. Jack manufacture
11. Production date
12. Representative company and address

## IF YOU HAVE A FLAT TIRE (WITH TIRE MOBILITY KIT, IF EQUIPPED)

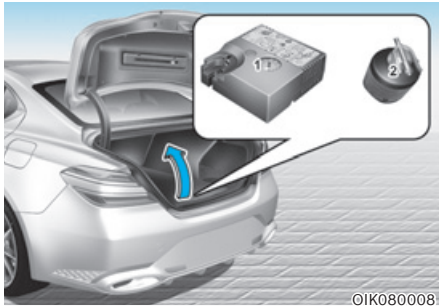

For safe operation, carefully read and follow the instructions in this manual before use.

- (1) Compressor
- (2) Sealant bottle

The Tire Mobility Kit is a temporary fix to the tire and the tire should be inspected by an authorized retailer of Genesis Branded products or the equivalent approved for your vehicle as soon as possible.

### CAUTION

**When two or more tires are flat, do not use the tire mobility kit because the supported one sealant of Tire Mobility Kit is only used for one flat tire.**

### WARNING

**Do not use the Tire Mobility Kit to repair punctures in the tire walls. This can result in an accident due to tire failure.**

### WARNING

**Have your tire repaired as soon as possible. The tire may lose air pressure at any time after inflating with the Tire Mobility Kit.**

## Introduction

With the Tire Mobility Kit, you can keep the mobile even after experiencing a tire puncture.

The compressor and sealing compound system effectively and comfortably seals most punctures in a passenger car tire caused by nails or similar objects and reinflates the tire.

After you ensure that the tire is properly sealed, you can drive cautiously (distance up to 120 miles (200 km)) at a max. speed of (50 mph (80 km/h)) in order to reach a service station or tire dealer for the tire replacement.

It is possible that some tires, especially with larger punctures or damage to the sidewall, cannot be sealed completely.

Air pressure loss in the tire may adversely affects tire performance.

For this reason, you should avoid abrupt steering or other driving maneuvers, especially if the vehicle is heavily loaded or if a trailer is in use.

The Tire Mobility Kit is not designed or intended as a permanent tire repair method and is to be used for one tire only.

This instruction shows you how to temporarily seal the puncture simply and reliably.

Read the section "Notes on the safe use of the Tire Mobility Kit".



### WARNING

**Do not use the TMK if a tire is severely damaged by driving run flat or with insufficient air pressure.**

**Only punctured areas located within the tread region of the tire can be sealed using the TMK.**

### Notes on the Safe use of the Tire Mobility Kit

- Park your car at the side of the road so that you can work with the Tire Mobility Kit away from moving traffic.
- To be sure your vehicle does not move, even when you're on fairly level ground, always set your parking brake.
- Only use the Tire Mobility Kit for sealing/inflation passenger car tires. Only punctured areas located within the tread region of the tire can be sealed using the tire mobility kit.
- Do not use on motorcycles, bicycles or any other type of tires.
- When the tire and wheel are damaged, do not use Tire Mobility Kit for your safety.
- Use of the Tire Mobility Kit may not be effective for tire damage larger than approximately 0.16in. (4mm)  
Please contact the nearest retailer of Genesis Branded products if the tire cannot be made roadworthy with the Tire Mobility Kit.
- Do not use the Tire Mobility Kit if a tire is severely damaged by driving run flat or with insufficient air pressure.
- Do not remove any foreign objects such as nails or screws that have penetrated the tire.
- Provided the car is outdoors, leave the engine running. Otherwise operating the compressor may eventually drain the car battery.
- Never leave the Tire Mobility Kit unattended while it is being used.
- Do not leave the compressor running for more than 10 minutes at a time or it may overheat.
- Do not use the Tire Mobility Kit if the ambient temperature is below -22°F(-30°C).
- In case of skin contact with the sealant, wash the area thoroughly with plenty of water. If the irritation persists, seek medical attention.
- In case of eye contact with the sealant, flush your eyes for at least 15 minutes. If the irritation persists, seek medical attention.
- In case of swallowing the sealant, rinse the mouth and drink plenty of water. However, never give anything to an unconscious person and seek medical attention immediately.
- Long time exposure to the sealant may cause damage to bodily tissue such as kidney, etc.

## Components of the Tire Mobility Kit

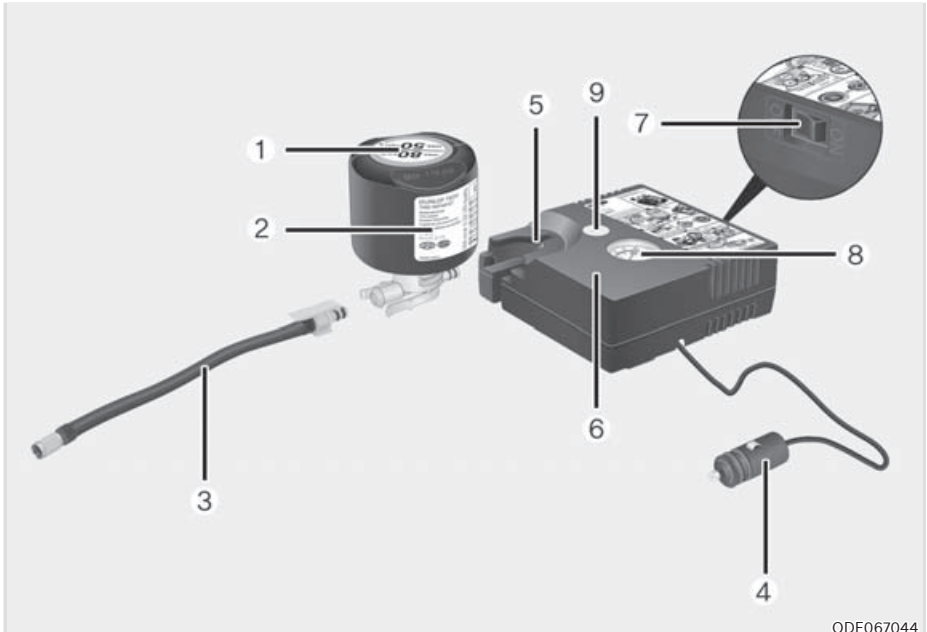

ODE067044

1. Speed-restriction label
2. Sealant bottle and label with speed restriction
3. Filling hose
4. Connectors and cable for the power outlet direct connection
5. Holder for the sealant bottle
6. Compressor
7. ON/OFF switch
8. Pressure gauge for displaying the tire inflation pressure
9. Button for reducing the tire inflation pressure

Connectors, cable and connection hose are stored in the compressor housing. Strictly follow the specified sequence, otherwise the sealant may escape under high pressure.



### **WARNING**

#### **Expired sealant**

**Do not use the tire sealant after the sealant has expired (i.e. expiration date on the sealant container). This can increase the risk of tire failure.**

**WARNING**

**Sealant**

- Keep out of reach of children.
- Avoid contact with eyes.
- Do not swallow.

**Using the Tire Mobility Kit When a Tire is Flat**

**CAUTION**

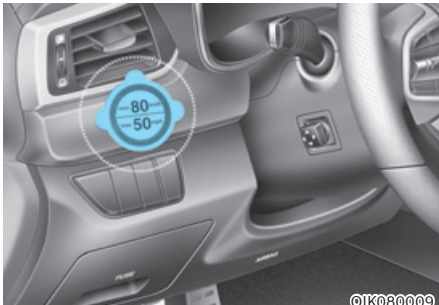

Detach the speed restriction label (1) from the sealant bottle (2), and place it in a highly visible place inside the vehicle such as on the steering wheel to remind the driver not to drive too fast.

**CAUTION**

If only the tire pressure needs to be adjusted, refer to “How to Adjust Tire Pressure” in this chapter.

Before using the Tire Mobility Kit, be fully aware of the explanation on the sealant.

1. Shake the sealant bottle (2).

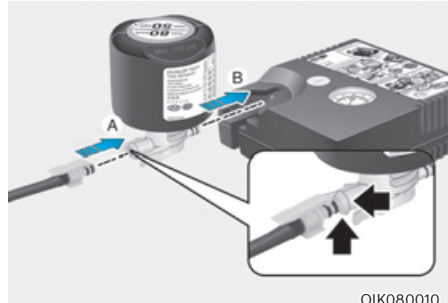

2. Connect the filling hose (3) to the sealant bottle (2) in the direction of (A) and connect the sealant bottle to the compressor (6) in the direction of (B).
3. Ensure that the compressor is switched OFF.
4. Unscrew the valve cap from the valve of the defective wheel and screw the filling hose (3) of the sealant bottle onto the valve.

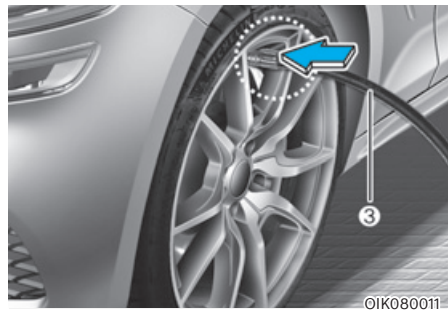

**CAUTION**

Securely install the sealant filling hose to the valve. If not, sealant may flow backward, possibly clogging the filling hose.

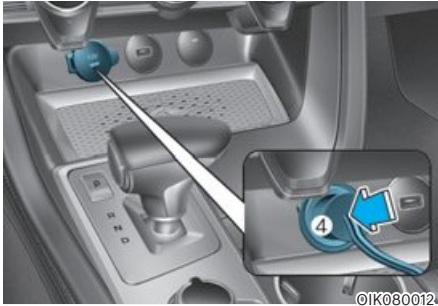

5. Plug the compressor power cord (4) into the vehicle power outlet.

### NOTICE

**Only use the front passenger side power outlet when connecting the power cord.**

6. Switch on the ignition switch.
7. Switch on the compressor and let it run for approximately 5~7 minutes to fill the sealant up to proper pressure. (refer to the Tire and Wheels, chapter 2). The inflation pressure of the tire after filling is unimportant and will be checked/corrected later.

Be careful not to overinflate the tire and stay away from the tire when filling it.



### CAUTION

#### Tire pressure

**Do not attempt to drive your vehicle if the tire pressure is below 29 psi (200 kPa). This could result in an accident due to sudden tire failure.**

8. Switch off the compressor.
9. Detach the hoses from the sealant bottle connector and from the tire valve.

Return the Tire Mobility Kit to its storage location in the vehicle.



### WARNING

#### Carbon monoxide

**Do not leave your vehicle running in a poorly ventilated area for extended periods of time. Carbon monoxide poisoning and suffocation can occur.**

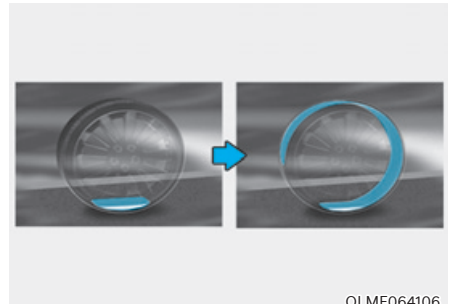

10. Immediately drive approximately 4~6 miles (7~10 km or, about 10min) to evenly distribute the sealant in the tire.

Do not exceed a speed of 50 mph (80 km/h). If possible, do not fall below a speed of 12 mph (20 km/h).

While driving, if you experience any unusual vibration, ride disturbance or noise, reduce your speed and drive with caution until you can safely pull off of the vehicle on the side of the road.

Call for road side service or towing.

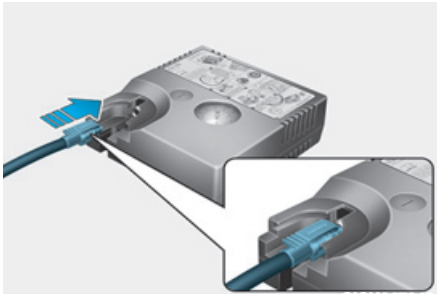

OIGH067043



OIK080011

11. After driving approximately 4~6 miles (7~10 km or about 10 min), stop at a safety location.
12. Connect the filling hose (3) of the compressor directly to the tire valve.
13. Plug the compressor power cord into the vehicle power outlet.
14. Adjust the tire inflation pressure to the recommended tire inflation.

With the ignition switched on, proceed as follows.

- **To increase the inflation pressure**  
: Switch on the compressor. To check the current inflation pressure setting, briefly switch off the compressor.
- **To reduce the inflation pressure:**  
Press the button (9) on the compressor.

### NOTICE

Do not let the compressor run for more than 10 minutes, otherwise the device will overheat and may be damaged.

### Information

The pressure gauge may show higher than actual reading when the compressor is running. To get an accurate tire reading, the compressor needs to be turned off.

### CAUTION

If the inflation pressure is not maintained, drive the vehicle a second time, refer to step 10.

Then repeat steps 1 to 4.

Use of the TMK may be ineffectual for tire damage larger than approximately 0.16 in (4 mm).

Have you contact an authorized retailer of Genesis Branded products if the tire cannot be made roadworthy with the Tire Mobility Kit.

### WARNING

The tire inflation pressure must be at least 32 psi (220 kPa). If it is not, do not continue driving.

Call for road side service or towing.

### CAUTION

Tire pressure sensor (if equipped with TPMS)

The sealant on the tire pressure sensor and wheel should be removed when you replace the tire with a new one and inspect the tire pressure sensors at an authorized dealer.

### Information

When reinstalling the repaired or replaced tire and wheel on the vehicle, tighten the wheel lug nut to 79~94 lbf·ft (11~13 kgf·m).



## How to Adjust Tire Pressure

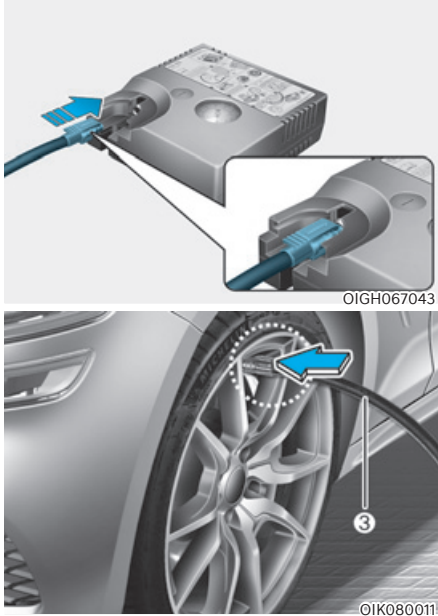

1. Park your vehicle in a safe location.
2. Connect the filling hose (3) of the compressor directly to the tire valve.
3. Plug the compressor power cord into the vehicle power outlet.
4. Adjust the tire inflation pressure to the recommended tire inflation.

With the ignition switched on, proceed as follows.

- **To increase the inflation pressure**  
: Switch on the compressor. To check the current inflation pressure setting, briefly switch off the compressor.
- **To reduce the inflation pressure:**  
Press the button (9) on the compressor.

### NOTICE

Do not let the compressor run for more than 10 minutes, otherwise the device will overheat and may be damaged.

### Information

The pressure gauge may show higher than actual reading when the compressor is running. To get an accurate tire reading, the compressor needs to be turned off.

### CAUTION

Do not use the sealant when the tire pressure only needs to be adjusted.

### WARNING

The tire inflation pressure must be at least 32 psi (220 kPa). If it is not, do not continue driving.

Call for road side service or towing.

## TOWING

### Towing Service

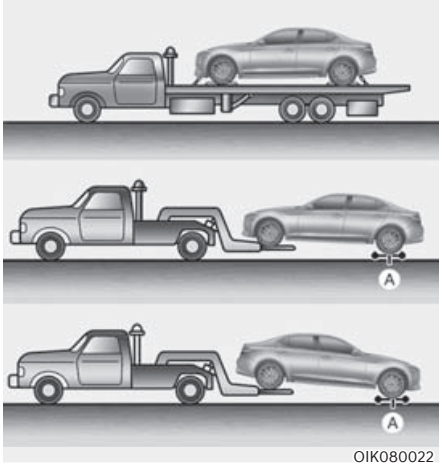

[A] : Dollies

If emergency towing is necessary, we recommend having it done by an authorized retailer of Genesis Branded products or a commercial tow-truck service.

Proper lifting and towing procedures are necessary to prevent damage to the vehicle. The use of wheel dollies or flatbed is recommended.

For 2WD vehicles, it is acceptable to tow the vehicle with the front wheels on the ground (without dollies) and the rear wheels off the ground.

If any of the loaded wheels or suspension components are damaged or the vehicle is being towed with the rear wheels on the ground, use a towing dolly under the rear wheels.

When being towed by a commercial tow truck and wheel dollies are not used, the rear of the vehicle should always be lifted, not the front.

For AWD vehicles, it must be towed with a wheel lift and dollies or flatbed equipment with all the wheels off the ground.

### NOTICE

**Do not lift the vehicle by the tow fitting or body and chassis parts. Otherwise the vehicle may be damaged.**



### CAUTION

- **Do not tow the vehicle with the rear wheels on the ground as this may cause damage to the vehicle.**

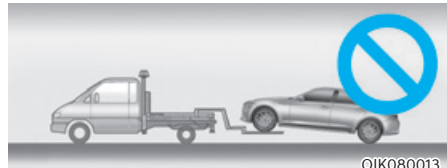

- **Do not tow with sling-type equipment. Use wheel lift or flatbed equipment.**



## WARNING

If your vehicle is equipped with a rollover sensor, press the Engine Start/ Stop button to the OFF or ACC position when the vehicle is being towed. The side impact and curtain air bag may deploy if the sensor detects the situation as a rollover.

When towing your vehicle in an emergency without wheel dollies:

1. Place the shift lever in N (Neutral).
2. Release the parking brake.

## NOTICE

Failure to place the shift lever in N (Neutral) when being towed with the front wheels on the ground can cause internal damage to the transmission.

## Removable Towing Hook

1. Open the trunk, and remove the towing hook from the tool case.

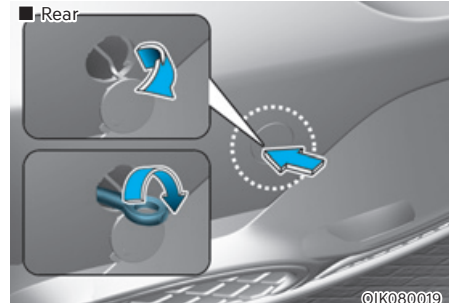
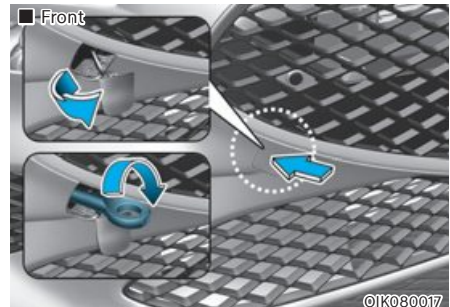

2. Remove the hole cover by pressing the lower part of the cover on the bumper.
3. Install the towing hook by turning it clockwise into the hole until it is fully secured.
4. Remove the towing hook and install the cover after use.

### Emergency Towing

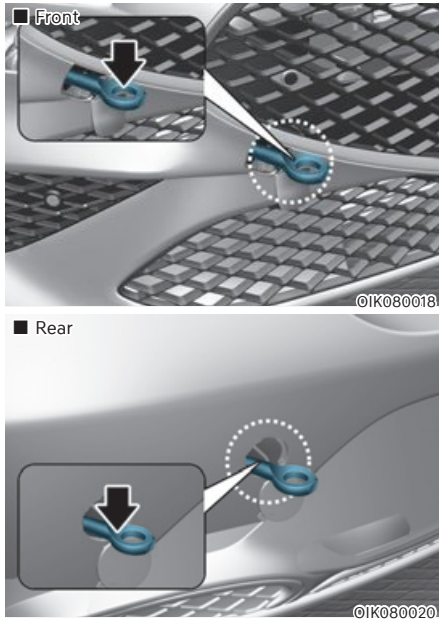

If towing is necessary, we recommend you have it done by an authorized retailer of Genesis Branded products or a commercial tow truck service.

If towing service is not available in an emergency, your vehicle may be temporarily towed using a cable or chain secured to the emergency towing hook at the front (or rear) of the vehicle.

Use extreme caution when towing the vehicle with a cable or chain. A driver must be in the vehicle to steer it and operate the brakes.

Towing in this manner may be done only on hard-surfaced roads for a short distance and at low speeds. Also, the wheels, axles, power train, steering and brakes must all be in good working condition.

### CAUTION

**The driver must be in the vehicle for steering and braking operations when the vehicle is being towed. Passengers other than the driver must not be in the vehicle.**

Always follow these emergency towing precautions:

- Press the Engine Start/Stop button to the ACC position so the steering wheel is not locked.
- Shift the gear to N (Neutral).
- Release the parking brake.
- Depress the brake pedal with more force than normal as you will have reduced braking performance.
- More steering effort will be required because the power steering system will be disabled.
- Use a vehicle heavier than your own to tow your vehicle.
- The drivers of both vehicles should communicate with each other frequently.
- Before emergency towing, check that the hook is not broken or damaged.
- Fasten the towing cable or chain securely to the hook.
- Do not jerk the hook. Apply steady and even force.

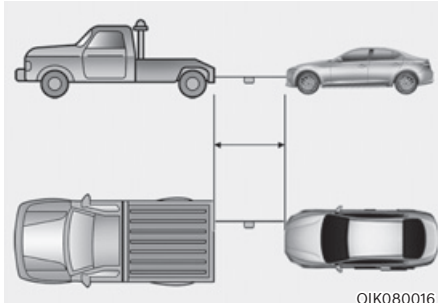

- Use a towing cable or chain less than 16 ft. (5 m) long. Attach a white or red cloth (about 12 in. (30 cm) width) in the middle of the cable or chain for easy visibility.
- Drive carefully so the towing cable or chain remains tight during towing.
- Before towing, check the automatic transmission for fluid leaks under your vehicle. If the automatic transmission fluid is leaking, flatbed equipment or a towing dolly must be used.

### NOTICE

Accelerate or decelerate the vehicle in a slow and gradual manner while maintaining tension on the tow rope or chain to start or drive the vehicle, otherwise tow hooks and the vehicle may be damaged.

### NOTICE

To avoid damage to your vehicle and vehicle components when towing:

- Always pull straight ahead when using the towing hooks. Do not pull from the side or at a vertical angle.
- Do not use the towing hooks to pull a vehicle out of mud, sand or other conditions from which the vehicle cannot be driven out under its own power.
- Limit the vehicle speed to 10 mph (15 km/h) and drive less than 1 mile (1.5 km) when towing to avoid serious damage to the automatic transmission.

# 9. Maintenance

Engine Compartment .....	9-3
Maintenance Services .....	9-4
Owner's Responsibility .....	9-4
Owner Maintenance Precautions.....	9-4
Owner Maintenance .....	9-5
Owner Maintenance Schedule.....	9-6
Scheduled Maintenance Services .....	9-7
Normal Maintenance Schedule.....	9-8
Maintenance Under Severe Usage Conditions .....	9-12
Explanation of Scheduled Maintenance Items.....	9-14
Vacuum crankcase ventilation hoses.....	9-14
Brake Fluid .....	9-16
Parking Brake.....	9-16
Brake Discs, Pads, Calipers and Rotors .....	9-16
Exhaust Pipe and Muffler .....	9-16
Engine Oil .....	9-17
Checking the Engine Oil Level.....	9-17
Checking the Engine Oil and Filter .....	9-19
Engine Coolant.....	9-20
Checking the Coolant Level.....	9-20
Changing Coolant .....	9-22
Brake Fluid.....	9-23
Checking the Brake Fluid Level .....	9-23
Washer Fluid.....	9-24
Checking the Washer Fluid Level.....	9-24
Air cleaner .....	9-25
Filter Replacement.....	9-25
Cabin Air Filter.....	9-26
Filter Inspection.....	9-26
Filter Replacement.....	9-26
Wiper Blades .....	9-27
Blade Inspection .....	9-27
Blade Replacement.....	9-27
Battery .....	9-29
Battery Usage Recommendations .....	9-30
Battery Replacement .....	9-30
Battery Recharging .....	9-30
Reset Items.....	9-31

Tires and Wheels.....	9-32
Tire Care.....	9-32
Recommended Cold Tire Inflation Pressures.....	9-32
Check tire Inflation Pressure .....	9-33
Tire Rotation .....	9-34
Wheel Alignment and Tire Balance.....	9-35
Tire Replacement .....	9-35
Wheel Replacement.....	9-36
Tire Traction .....	9-36
Tire Maintenance.....	9-36
Tire Sidewall Labeling .....	9-37
Tire Terminology and Definitions .....	9-40
All Season Tires.....	9-43
Summer Tires .....	9-43
Snow Tires.....	9-43
Radial-Ply Tires.....	9-43
Low Aspect Ratio Tires.....	9-44
Fuses.....	9-45
Instrument Panel Fuse Replacement.....	9-46
Engine Compartment Panel Fuse Replacement.....	9-47
Fuse/Relay Panel Description.....	9-48
Light Bulbs.....	9-61
Headlamp, position lamp, turn signal lamp, Daytime Running Light (DRL) replacement .....	9-62
Side Repeater Lamp Replacement .....	9-62
Puddle Lamp Replacement .....	9-63
Rear Combination Lamp Replacement .....	9-63
High Mounted Stop Lamp Replacement.....	9-64
License Plate Lamp Replacement.....	9-64
Interior Light Replacement.....	9-65
Appearance Care .....	9-66
Exterior Care.....	9-66
Interior Care.....	9-72
Emission Control System.....	9-75
California Perchlorate Notice.....	9-77

## ENGINE COMPARTMENT

### ■ 2.0L T-GDI



### ■ 3.3L T-GDI

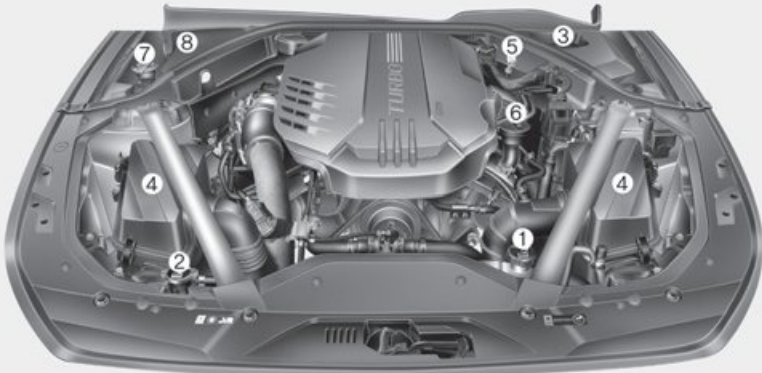

The actual engine compartment in the vehicle may differ from the illustration.

OIK077001/OIK017007

- |                             |                                      |
|-----------------------------|--------------------------------------|
| 1. Engine coolant reservoir | 5. Engine oil dipstick               |
| 2. Radiator cap             | 6. Engine oil filler cap             |
| 3. Brake fluid reservoir    | 7. Windshield washer fluid reservoir |
| 4. Air cleaner              | 8. Fuse box                          |

\* The battery is in trunk.



## MAINTENANCE SERVICES

You should exercise the utmost care to prevent damage to your vehicle and injury to yourself whenever performing any maintenance or inspection procedures.

We recommend you have your vehicle maintained and repaired by an authorized retailer of Genesis Branded products. An authorized retailer of Genesis Branded products meets Genesis Branded Vehicle's high service quality standards and receives technical support from Genesis Branded Vehicle in order to provide you with a high level of service satisfaction.

### Owner's Responsibility

Maintenance service and record retention are the owner's responsibility. You should retain documents that show proper maintenance has been performed on your vehicle in accordance with the scheduled maintenance service charts shown on the following pages. You need this information to establish your compliance with the servicing and maintenance requirements of your vehicle warranties.

Detailed warranty information is provided in your Owner's Handbook & Warranty Information booklet.

Repairs and adjustments required as a result of improper maintenance or a lack of required maintenance are not covered.

### Owner Maintenance Precautions

Inadequate, incomplete or insufficient servicing may result in operational problems with your vehicle that could lead to vehicle damage, an accident, or personal injury. This chapter provides instructions only for the maintenance items that are easy to perform. Several procedures can be done only by an authorized retailer of Genesis Branded products with special tools.

Your vehicle should not be modified in any way. Such modifications may adversely affect the performance, safety or durability of your vehicle and may, in addition, violate conditions of the limited warranties covering the vehicle.

Certain modifications may also be in violation of regulations established by the U.S. Department of Transportation and other federal or state agencies.

#### **NOTICE**

**Improper owner maintenance during the warranty period may affect warranty coverage. For details, read the separate Owner's Handbook & Warranty Information booklet provided with the vehicle. If you're unsure about any service or maintenance procedure, have it done by an authorized retailer of Genesis Branded products.**

## OWNER MAINTENANCE



### WARNING

Performing maintenance work on a vehicle can be dangerous. If you lack sufficient knowledge and experience or the proper tools and equipment to do the work, have it done by an authorized retailer of Genesis Branded products. **ALWAYS** follow these precautions for performing maintenance work:

- **Park your vehicle on level ground, shift the gear to the P(Park), apply the parking brake, press the Engine Start/Stop button to the OFF position.**
- **Block the tires (front and back) to prevent the vehicle from moving. Remove loose clothing or jewelry that can become entangled in moving parts.**
- **If you must operate the engine during maintenance, do so outdoors or in an area with plenty of ventilation.**
- **Keep flames, sparks, or smoking materials away from the battery and fuel-related parts.**



### WARNING

#### Touching metal parts



**Do not touch metal parts (including strut bars) while the engine is operating or hot. Doing so could result in serious personal injury. Turn the engine off and wait until the metal parts cool down to perform maintenance work on the vehicle.**

The following lists are vehicle checks and inspections that should be performed by the owner or an authorized retailer of Genesis Branded products at the frequencies indicated to help ensure safe, dependable operation of your vehicle.

Any adverse conditions should be brought to the attention of your dealer as soon as possible.

These Owner Maintenance vehicle checks are generally not covered by warranties and you may be charged for labor, parts and lubricants used.

## Owner Maintenance Schedule

### **When you stop for fuel:**

- Check the coolant level in the engine coolant reservoir or the liquid-cooled intercooler coolant reservoir.
- Check the windshield washer fluid level.
- Check for low or under-inflated tires.



### **WARNING**

**Be careful when checking your coolant level when the engine is hot. This may result in coolant being blown out of the opening and cause serious burns and other injuries.**

### **While operating your vehicle:**

- Note any changes in the sound of the exhaust or any smell of exhaust fumes in the vehicle.
- Check for vibrations in the steering wheel. Notice if there is any increased steering effort or looseness in the steering wheel, or change in its straight-ahead position.
- Notice if your vehicle constantly turns slightly or “pulls” to one side when traveling on smooth, level road.
- When stopping, listen and check for unusual sounds, pulling to one side, increased brake pedal travel or “hard-to-push” brake pedal.
- If any slipping or changes in the operation of your transmission occurs, check the transmission fluid level.
- Check the automatic transmission P (Park) function.
- Check the parking brake.
- Check for fluid leaks under your vehicle (water dripping from the air conditioning system during or after use is normal).

### **At least monthly:**

- Check coolant level in the engine coolant reservoir.
- Check the operation of all exterior lights, including the stoplights, turn signals and hazard warning flashers.
- Check the inflation pressures of all tires including the spare for tires that are worn, show uneven wear, or are damaged.
- Check for loose wheel lug nuts.

### **At least twice a year: (i.e., every Spring and Autumn)**

- Check radiator, heater and air conditioning hoses for leaks or damage.
- Check windshield washer spray and wiper operation. Clean wiper blades with a clean cloth dampened with washer fluid.
- Check headlamp alignment.
- Check muffler, exhaust pipes, shields and clamps.
- Check the seat belts for wear and function.

### **At least once a year:**

- Clean body and door drain holes.
- Lubricate door hinges and hood hinges.
- Lubricate door and hood locks and latches.
- Lubricate door rubber weather strips.
- Check the air conditioning system.
- Inspect and lubricate automatic transmission linkage and controls.
- Clean the battery and terminals.
- Check the brake fluid level.

## SCHEDULED MAINTENANCE SERVICES

Follow Normal Maintenance Schedule if the vehicle is usually operated where none of the following conditions apply. If any of the following conditions apply, you must follow the Maintenance Under Severe Usage Conditions.

- Repeated driving short distance of less than 5 miles (8 km) in normal temperature or less than 10 miles (16 km) in freezing temperature
- Extensive engine idling or low speed driving for long distances
- Driving on rough, dusty, muddy, unpaved, graveled or salt-spread roads
- Driving in areas using salt or other corrosive materials or in very cold weather
- Driving in heavy dust conditions
- Driving in heavy traffic areas
- Driving on uphill, downhill, or mountain road repeatedly
- Towing a trailer or using a camper, or driving with loads on the roof
- Driving as a patrol car, taxi, other commercial use of vehicle towing
- Frequently driving under high speed or rapid acceleration/deceleration.
- Frequently driving in stop-and-go condition
- Engine oil usage which is not recommended (Mineral type, Semi-synthetic, Lower grade spec, etc.)

If your vehicle is operated under the above conditions, you should inspect, replace or refill more frequently than the following Normal Maintenance Schedule. After the periods or distance shown in the chart, continue to follow the semi-synthetic, prescribed maintenance intervals.

### Information

- **As it is normal for engine oil to be consumed during driving, the engine oil level should be checked on regular basis.**
- **The engine oil change interval for normal operating conditions is based on the use of the recommended engine specification. If the recommended engine oil specification is not used, then replace the engine oil according to the maintenance schedule under severe operating conditions.**

## Normal Maintenance Schedule

MAINTENANCE INTERVALS	Number of months or driving distance, whichever comes first															
	Months	12	24	36	48	60	72	84	96	108	120	132	144	156	168	180
MAINTENANCE ITEM	Miles*1,000	6	12	18	24	30	36	42	48	54	60	66	72	78	84	90
	Km*1,000	10	20	30	40	50	60	70	80	90	100	110	120	130	140	150
Engine oil and engine oil filter		R	R	R	R	R	R	R	R	R	R	R	R	R	R	R
Fuel additives *1		Add every 7,500 miles (1,390 km)														
Rotate tires		Rotate every 6,000 miles (10,000 km)														
Cabin air filter (for evaporator and blower unit)		Replace every 16,000 miles (24,000 km)														
Air cleaner filter		I			R		I		R		I		R		I	
Spark plugs		Replace every 42,000 miles (70,000 km)														
Drive belts *2		At first, inspect at 60,000 miles (100,000 km) or 72 months, after that, inspect every 12,000 miles (20,000 km) or 24 months														
Valve clearance *3		Inspect every 60,000 miles (100,000 km) or 72 months														
Vacuum hose		I	I	I	I	I	I	I	I	I	I	I	I	I	I	I

I : Inspect and if necessary, adjust, correct, clean or replace.

R : Replace or change.

\*1: If TOP TIER Detergent Gasoline is not available, one bottle of additive is recommended. Additives are available from your authorized retailer of Genesis Branded products along with information on how to use them. Do not mix other additives.

\*2: The drive belt should be replaced when cracks occur or tension is reduced.

\*3: Inspect for excessive valve noise and/or engine vibration and adjust if necessary. Have an authorized retailer of Genesis Branded products perform the operation.

## Normal Maintenance Schedule (Cont.)

MAINTENANCE INTERVALS	Number of months or driving distance, whichever comes first														
	12	24	36	48	60	72	84	96	108	120	132	144	156	168	180
MAINTENANCE ITEM	Months	Miles×1,000	Km×1,000												
Engine coolant	At first, replace at 120,000 miles (200,000 km) or 10 years after that, replace every 24,000 miles (40,000 km) or 24 months														
Intercooler, in/out hose, air intake hose	I	I	I	I	I	I	I	I	I	I	I	I	I	I	I
Battery condition	I	I	I	I	I	I	I	I	I	I	I	I	I	I	I
All electrical systems	I	I	I	I	I	I	I	I	I	I	I	I	I	I	I
Brake lines, hoses and connections	I	I	I	I	I	I	I	I	I	I	I	I	I	I	I
Front brake disc/pads, calipers	I	I	I	I	I	I	I	I	I	I	I	I	I	I	I
Rear brake disc/pads	I	I	I	I	I	I	I	I	I	I	I	I	I	I	I
Steering gear rack, linkage and boots / lower arm ball joint, upper arm ball joint	I	I	I	I	I	I	I	I	I	I	I	I	I	I	I
Driveshaft and boots	I	I	I	I	I	I	I	I	I	I	I	I	I	I	I
Suspension mounting bolts	I	I	I	I	I	I	I	I	I	I	I	I	I	I	I
Air conditioner refrigerant	I	I	I	I	I	I	I	I	I	I	I	I	I	I	I
Air conditioner compressor	I	I	I	I	I	I	I	I	I	I	I	I	I	I	I
Propeller shaft	I	I	I	I	I	I	I	I	I	I	I	I	I	I	I
Exhaust pipe and muffler	I	I	I	I	I	I	I	I	I	I	I	I	I	I	I

I : Inspect and if necessary, adjust, correct, clean or replace.

R : Replace or change.

Normal Maintenance Schedule (Cont.)

MAINTENANCE INTERVALS		Number of months or driving distance, whichever comes first														
		12	24	36	48	60	72	84	96	108	120	132	144	156	168	180
MAINTENANCE ITEM	Months	6	12	18	24	30	36	42	48	54	60	66	72	78	84	90
	Miles*1,000	10	20	30	40	50	60	70	80	90	100	110	120	130	140	150
Automatic transmission fluid *4																
Differential oil (rear) *5 *6	Without LSD						I									I
	With LSD						R									R
Differential oil (front) (AWD) *5							I									I
Transfer case oil (AWD)																
Vapor hose, fuel filler cap and fuel tank		I					I									I

I : Inspect and if necessary, adjust, correct, clean or replace.

R : Replace or change.

\*4 : Use only the specified automatic transmission fluid. (Refer to "Recommended lubricants and capacities" in chapter 2 or the label in the engine compartment.)

\*5 : Front/rear differential oil should be changed anytime, front/rear differential have been submerged in water.

\*6 : When replacing differential oil with LSD (Limited Slip Differential), use only specified LSD oil.

## Normal Maintenance Schedule (Cont.)

MAINTENANCE INTERVALS	Number of months or driving distance, whichever comes first															
	Months	12	24	36	48	60	72	84	96	108	120	132	144	156	168	180
MAINTENANCE ITEM	Miles*1,000	6	12	18	24	30	36	42	48	54	60	66	72	78	84	90
	Km*1,000	10	20	30	40	50	60	70	80	90	100	110	120	130	140	150
Fuel tank air filter *7		I		I		I		I		I		I		I		I
Fuel lines, hoses and connections		I		I		I		I		I		I		I		I
Parking brake		I		I		I		I		I		I		I		I
Brake fluid		Inspect 8,000 mile (13,000 km) or 12 months, Replace every 48,000 miles (78,000 km) or 48 months														

I : Inspect and if necessary, adjust, correct, clean or replace.

R : Replace or change.

\*7 : Fuel filter & Fuel tank air filter are considered to be maintenance free but periodic inspection is recommended for this maintenance schedule depends on fuel quality. If there are some important safety matters like fuel flow restriction, surging, loss of power, hard starting problem, etc. replace the fuel filter immediately regardless of maintenance schedule and consult an authorized retailer of Genesis Branded products for details.



### Maintenance Under Severe Usage Conditions

The following items must be serviced more frequently on cars normally used under severe driving conditions. Refer to the chart below for the appropriate maintenance intervals.

R : Replace or change.

I : Inspect and if necessary, adjust, correct, clean or replace.

Maintenance item		Maintenance operation	Maintenance intervals	Driving condition
Engine oil and filter		R	Every 3,000 miles (5,000 km) or 6 months	A, B, C, D, E, F, G, H, I, J, K, L
Air cleaner filter		I	Inspect more frequently depending on the condition	C, E
Spark plugs		R	Replace more frequently depending on the condition	A, B, F, G, H, I, K
Automatic transmission fluid		R	Every 60,000 miles (100,000 km)	A,C,E,F,G, H,I,K
Front brake disc/pads, calipers		I	Inspect more frequently depending on the condition	C, D, E, G, H, J, K
Rear brake disc/pads		I	Inspect more frequently depending on the condition	C, D, E, G, H, J, K
Parking brake		I	Inspect more frequently depending on the condition	C, D, G, H
Steering gear box, linkage & boots/ Lower arm ball joint, upper arm ball joint		I	Inspect more frequently depending on the condition	C, D, E, F, G
Drive shafts and boots		I	Every 3,000 miles (5,000 km) or 6 months	C, D, E, F, G, H, I, J
Differential oil (front) (AWD)		I	Every 72,000 miles (120,000 km)	C, E, G, H, I, J
Differential oil (rear)	Without LSD	R	Every 72,000 miles (120,000 km)	C, E, G, H, I, J
	With LSD	R	Every 36,000 miles (60,000 km)	C, E, G, H, I, J
Cabin air filter (for evaporator and blower unit)		R	Inspect more frequently depending on the condition	C, E, G
Propeller shaft		I	Every 3,000 miles (5,000 km) or 6 months	C, E

***Severe driving conditions***

- A. Repeatedly driving short distances of less than 5 miles (8 km) in normal temperature or less than 10 miles (16 km) in freezing temperature
- B. Extensive engine idling or low speed driving for long distances
- C. Driving on rough, dusty, muddy, unpaved, graveled or salt- spread roads
- D. Driving in areas using salt or other corrosive materials or in very cold weather
- E. Driving in heavy dust conditions
- F. Driving in heavy traffic area
- G. Driving on uphill, downhill, or mountain road
- H. Towing a trailer or using a camper, or driving with loads on the roof
- I. Driving as a patrol car, taxi, other commercial use or vehicle towing
- J. Frequently driving under high speed or rapid acceleration/deceleration.
- K. Frequently driving in stop-and-go conditions
- L. Engine oil usage which is not recommended (Mineral type, Semi-synthetic, Lower grade spec, etc.)

## EXPLANATION OF SCHEDULED MAINTENANCE ITEMS

### Engine Oil and Filter

The engine oil and filter should be changed at the intervals specified in the maintenance schedule. If the vehicle is being driven in severe conditions, more frequent oil and filter changes are required.

### Drive Belts

Inspect all drive belts for evidence of cuts, cracks, excessive wear or oil saturation and replace if necessary.

Drive belts should be checked periodically for proper tension and adjusted as necessary.

### Information

**When you are inspecting the belt, turn the engine off.**

### Fuel Lines, Fuel Hoses and Connections

Check the fuel lines, fuel hoses and connections for leakage and damage. Have an authorized retailer of Genesis Branded products replace any damaged or leaking parts immediately.

### Fuel Filter

The fuel filter is considered to be maintenance free but periodic inspection is recommended for this maintenance depends on fuel quality. If there are some important matters like fuel flow restriction, surging, loss of power, hard starting problem etc., replace the fuel filter immediately. We recommend that you consult an authorized retailer of Genesis Branded products for details.

### Vapor Hose and Fuel Filler Cap

The vapor hose and fuel filler cap should be inspected at those intervals specified in the maintenance schedule. Make sure a new vapor hose or fuel filler cap is correctly replaced.

### Vacuum crankcase ventilation hoses (if equipped)

Inspect the surface of hoses for evidence of heat and/or mechanical damage. Hard and brittle rubber, cracking, tears, cuts, abrasions, and excessive swelling indicate deterioration. Particular attention should be paid to examine those hose surfaces nearest to high heat sources, such as the exhaust manifold.

Inspect the hose routing to ensure that the hoses do not come in contact with any heat source, sharp edges or moving component which might cause heat damage or mechanical wear. Inspect all hose connections, such as clamps and couplings, to make sure they are secure, and that no leaks are present. Hoses should be replaced immediately if there is any evidence of deterioration or damage.

## Air Cleaner Filter

We recommend that the air cleaner filter be replaced by an authorized retailer of Genesis Branded products.

## Spark Plugs

Make sure to install new spark plugs of the correct heat range.

When assembling parts, be sure to wipe out foreign substances inside and outside of the boot bottom of the ignition coil and the insulator of the spark plug with a soft cloth to prevent contamination of the spark plug insulator.

## Cooling System

Check cooling system components, such as radiator, coolant reservoir, hoses and connections for leakage and damage. Replace any damaged parts.

## Engine Coolant

The coolant should be changed at the intervals specified in the maintenance schedule.

## Automatic Transmission Fluid

Automatic transmission fluid should not be checked under normal usage conditions, the Automatic transmission fluid should be changed by an authorized retailer of Genesis Branded products according to the maintenance schedule.

## Information

**Automatic transmission fluid color is red when new.**

**As the vehicle is driven, the automatic transmission fluid will begin to look darker.**

**This is a normal condition. It does not need to be replaced based on the color change.**

## **NOTICE**

**The use of a non-specified fluid could result in transmission malfunction and failure.**

**Use only specified automatic transmission fluid. (Refer to “Recommended Lubricants and Capacities” section in chapter 2.)**

### Brake Hoses and Lines

Visually check for proper installation, chafing, cracks, deterioration and any leakage. Replace any deteriorated or damaged parts immediately.

### Brake Fluid

Check the brake fluid level in the brake fluid reservoir. The level should be between the MIN and the MAX marks on the side of the reservoir. Use only hydraulic brake fluid conforming to DOT 4 specification.

### Parking Brake

Inspect the parking brake system including the parking brake pedal and cables.

### Brake Discs, Pads, Calipers and Rotors

Check the pads for excessive wear, discs for run out and wear, and calipers for fluid leakage.

### Exhaust Pipe and Muffler

Visually inspect the exhaust pipes, muffler and hangers for cracks, deterioration, or damage. Start the engine and listen carefully for any exhaust gas leakage. Tighten connections or replace parts as necessary.

### Suspension Mounting Bolts

Check the suspension connections for looseness or damage. Retighten to the specified torque.

### Steering Gear box, Linkage & Boots/Lower Arm Ball Joint

With the vehicle stopped and the engine off, check for excessive free-play in the steering wheel. Check the linkage for bends or damage. Check the dust boots and ball joints for deterioration, cracks, or damage.

Replace any damaged parts.

### Drive Shafts and Boots

Check the drive shafts, boots and clamps for cracks, deterioration, or damage. Replace any damaged parts and, if necessary, repack the grease.

### Air Conditioning Refrigerant

Check the air conditioning lines and connections for leakage and damage.

## ENGINE OIL

### Checking the Engine Oil Level

#### NOTICE

Engine oil is used for lubricating, cooling, and operating various hydraulic components in the engine. Engine oil consumption while driving is normal, and it is necessary to check and refill the engine oil regularly. Also, check and refill the oil level within the recommended maintenance schedule to prevent deterioration of oil performance.

Check the engine oil following the below procedure.

1. Follow all of the oil manufacturer's precautions.
2. Be sure the vehicle is on the level ground in P (Park) with the parking brake set and the wheels blocked.
3. Turn the engine on and warm the engine up until the coolant temperature reaches a constant normal temperature.
4. Turn the engine off, remove the oil filler cap and pull the dipstick out. Wait for 15 minutes for the oil to return to the oil pan.
5. Wipe the dipstick clean and re-insert it fully.
6. Pull the dipstick out again and check the level. The level should be between F (Full) and L (Low).

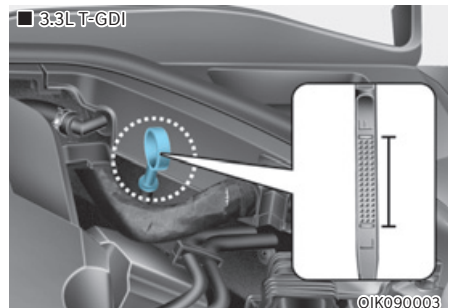
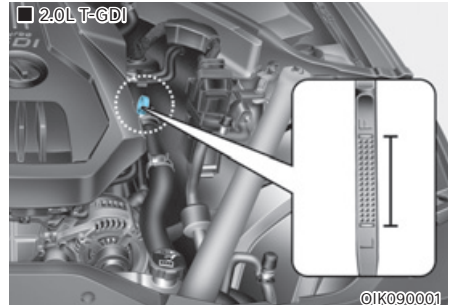

■ 2.0L T-GDI

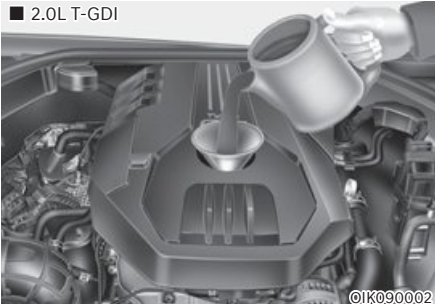

■ 3.3L T-GDI

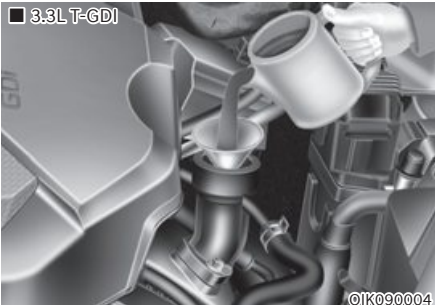

**NOTICE**

To prevent damage to your engine:

- Do not spill engine oil when adding or changing engine oil. Wipe off spilled oil immediately.
- The engine oil consumption may increase while you break in a new vehicle and it will be stabilized after driving 4,000 miles (6,000 km).
- The engine oil consumption can be affected by driving habits, climate conditions, traffic conditions, oil quality, etc. Therefore, it is recommended that you inspect the engine oil level regularly and refill it if necessary.

7. If the oil level is below the L, add enough oil to bring the level to F.

Use only the specified engine oil (Refer to “Recommended Lubricants and Capacities” section in chapter 2).

## Checking the Engine Oil and Filter



- We recommend that the engine oil and filter be changed by an authorized retailer of Genesis Branded products according to the Maintenance Schedule at the beginning of this chapter.
- If the maintenance schedule to replace engine oil is exceeded, the engine oil performance may deteriorate, and the engine condition may be affected. Therefore, replace the engine oil according to the maintenance schedule.
- To keep the engine in optimal condition, use the recommended engine oil and filter. If the recommended engine oil and filter are not used replace it according to the maintenance schedule under severe usage conditions.
- The purpose of the maintenance schedule for engine oil replacement is to prevent oil deterioration and it is irrelevant to oil consumption. Check and refill engine oil regularly.



### CAUTION

The engine oil is very hot immediately after the vehicle has been driven and can cause burns during replacement. Replace the engine oil after the engine oil has cooled down.



### WARNING

#### CALIFORNIA PROPOSITION 65 WARNING

Engine oil contains chemicals known to the State of California to cause cancer, birth defects and reproductive harm.

Used engine oil may cause irritation or cancer of the skin if left in contact with the skin for prolonged periods of time.

**Always protect your skin by washing your hands thoroughly with soap and warm water as soon as possible after handling used oil.**



## ENGINE COOLANT

The high-pressure cooling system has a reservoir filled with year-round antifreeze coolant. The reservoir is filled at the factory.

Check the antifreeze protection and coolant level at least once a year, at the beginning of the winter season and before traveling to a colder climate.

### Checking the Coolant Level

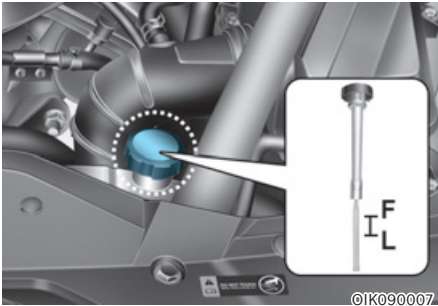

Check the condition and connections of all cooling system hoses and heater hoses. Replace any swollen or deteriorated hoses.

The coolant level should be filled between the MAX and the MIN marks on the side of the coolant reservoir when the engine is cool.

If the coolant level is low, add enough distilled (deionized) water to bring the level to the MAX mark, but do not overfill. If frequent additions are required, see an authorized retailer of Genesis Branded products for a cooling system inspection.

### WARNING



Never remove the engine coolant radiator cap, coolant cap or the drain plug while the engine and radiator are hot. Hot coolant and steam may blow out under pressure, causing serious injury.

Turn the vehicle off and wait until the engine cools down. Use extreme care when removing the radiator cap, coolant cap. Wrap a thick towel around it, and turn it counterclockwise slowly to the first stop. Step back while the pressure is released from the cooling system. When you are sure all the pressure has been released, press down on the cap, using a thick towel, and continue turning counterclockwise to remove it.

### Information

The coolant level is influenced by the engine temperature. Before checking or refilling the coolant, turn the engine off.

### WARNING



The electric motor for the cooling fan may continue to operate or start up when the engine is not running and can cause serious injury. Keep hands, clothing and tools away from the rotating fan blades of the cooling fan.

Always turn off the vehicle unless the vehicle has to be inspected with the engine on. Be cautious as the cooling fan may operate if the negative (-) battery terminal is not disconnected.

## WARNING

Make sure the coolant cap is properly closed after refilling coolant. Otherwise the engine could be overheated while driving.

■ Engine compartment front view

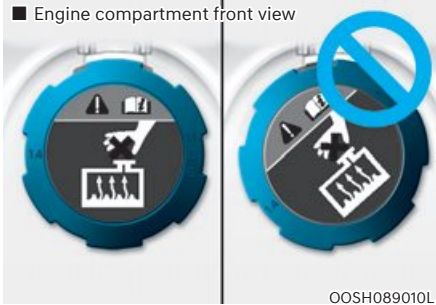

OOSH089010L

1. Check if the coolant cap label is straight in front.

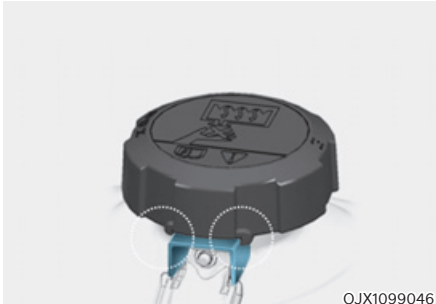

OJX1099046

2. Make sure that the tiny protrusions inside the coolant cap is securely interlocked.

## Recommended coolant

- When adding coolant, use only deionized water, distilled water or soft water for your vehicle and never mix hard water in the coolant filled at the factory.
- An incorrect coolant mixture can result in severe malfunction or engine damage.
- The engine in your vehicle has aluminum engine parts and must be protected by a phosphate-based ethylene glycol coolant to prevent corrosion and freezing.
- Do not use alcohol or methanol coolant or mix them with the specified coolant.
- Do not use a solution that contains more than 60% antifreeze or less than 35% antifreeze, which would reduce the effectiveness of the solution.

For mixing percentage, refer to the following table:

Ambient Temperature	Mixture Percentage (volume)	
	Antifreeze	Water
5°F (-15°C)	35	65
-13°F (-25°C)	40	60
-31°F (-35°C)	50	50
-49°F (-45°C)	60	40

## Information

If in doubt about the mix ratio, a 50% water and 50% antifreeze mix is the easiest to mix together as it will be the same quantity of each. It is suitable to use for most temperature ranges of -31°F (-35°C) and higher.

## Changing Coolant

we recommend that the coolant be changed by an authorized retailer of Genesis Branded products according to the Maintenance Schedule at the beginning of this chapter.



### **WARNING**

**Do not use engine coolant or antifreeze in the washer fluid reservoir.**

**Engine coolant can severely obscure visibility when sprayed on the windshield and may cause loss of vehicle control resulting in an accident.**

**Engine coolant may also cause damage to paint and body trim.**

### **NOTICE**

**To prevent damage to engine parts, put a thick towel around the engine coolant cap before refilling the coolant to prevent the coolant from overflowing into engine parts, such as the alternator.**

## BRAKE FLUID

### Checking the Brake Fluid Level

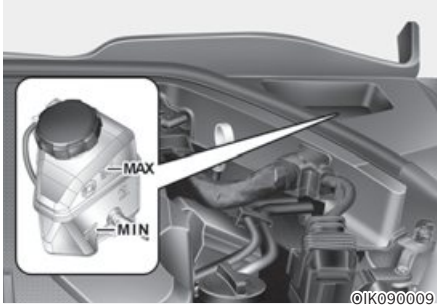

Check the fluid level in the reservoir periodically. The fluid level should be between MAX and MIN marks on the side of the reservoir.

Before removing the reservoir cap and adding brake fluid, clean the area around the reservoir cap thoroughly to prevent brake fluid contamination.

If the level is low, add the specified brake fluid to the MAX level. The level will fall with accumulated mileage. This is a normal condition associated with the wear of the brake linings. If the fluid level is excessively low, we recommend that the brake system be checked by an authorized retailer of Genesis Branded products.



### WARNING

**If the brake system requires frequent additions of fluid, this could indicate a leak in the brake system. We recommend that the vehicle be inspected by an authorized retailer of Genesis Branded products.**



### WARNING

**Do not allow brake fluid to come in contact with your eyes. If brake fluid comes in contact with your eyes, flush your eyes with clean water for at least 15 minutes and get immediate medical attention.**

### NOTICE

- **Do not allow brake fluid to contact the vehicle's body paint, as paint damage will result.**
- **Brake fluid, which has been exposed to open air for an extended time should NEVER be used as its quality cannot be guaranteed. It should be disposed of properly.**
- **Do not use the incorrect type of brake fluid. A few drops of mineral based oil, such as engine oil, in your brake system can damage brake system parts.**



### Information

**Use only the specified brake fluid (refer to “Recommended Lubricants and Capacities” section in chapter 2).**

## WASHER FLUID

### Checking the Washer Fluid Level

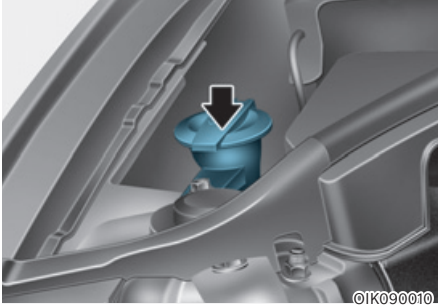

Check the fluid level in the washer fluid reservoir and add fluid if necessary. Plain water may be used if washer fluid is not available. However, use washer solvent with antifreeze characteristics in cold climates to prevent freezing.

### **WARNING**

To prevent serious injury or death, take the following safety precautions when using washer fluid:

- Do not use engine coolant or antifreeze in the washer fluid reservoir. Engine coolant can severely obscure visibility when sprayed on the windshield and may cause loss of vehicle control resulting in an accident or damage to paint and body trim.
- Do not allow sparks or flame to contact the washer fluid or the washer fluid reservoir. Washer fluid may contain alcohol and can be flammable.
- Do not drink washer fluid and avoid contact with skin. Washer fluid is harmful to humans and animals.
- Keep washer fluid away from children and animals.

## AIR CLEANER

### Filter Replacement

■ 2.0L T-CDI

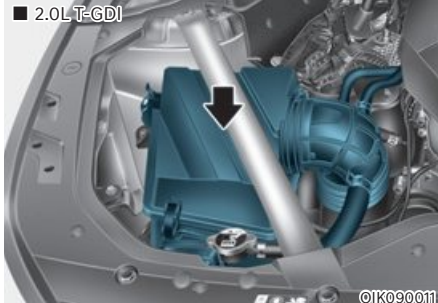

■ 3.3L T-CDI (Passenger side)

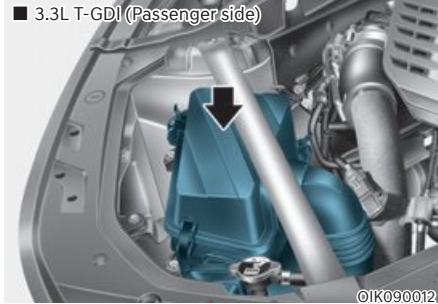

■ 3.3L T-CDI (Driver side)

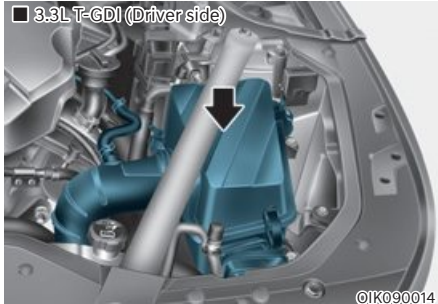

Do not attempt to wash or to rinse it, as water will damage the filter.

If soiled, the air cleaner filter must be replaced.

Have you visit an authorized retailer of Genesis Branded products to replace air cleaner filter.

Replace the filter according to the Maintenance Schedule.

### **i** Information

If the vehicle is operated in extremely dusty or sandy areas, replace the air cleaner filter more often than the usual recommended intervals (Refer to “Maintenance Under Severe Usage Conditions” section in this chapter).

### **NOTICE**

- Do not drive with the air cleaner filter removed. This will result in excessive engine wear.
- When removing the air cleaner filter, be careful that dust or dirt does not enter the air intake, or damage may result.
- We recommend that you use parts for replacement from an authorized retailer of Genesis Branded products.

## CABIN AIR FILTER

### Filter Inspection

The cabin air filter should be replaced according to the Maintenance Schedule. If the vehicle is operated in severely air-polluted cities or on dusty rough roads for a long period, it should be inspected more frequently and replaced sooner. Replace the cabin air filter by following the procedure below and be careful to avoid damaging other components.

### Filter Replacement

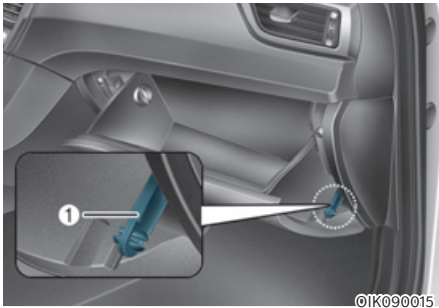

1. Open the glove box and remove the support rod (1).

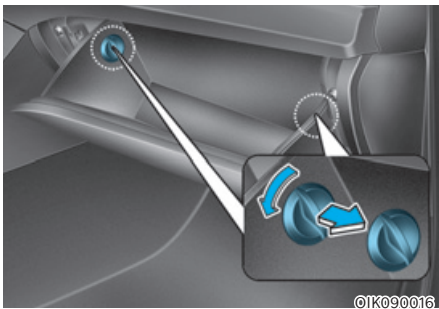

2. Remove the stoppers on both sides to allow the glove box to hang freely on the hinges.

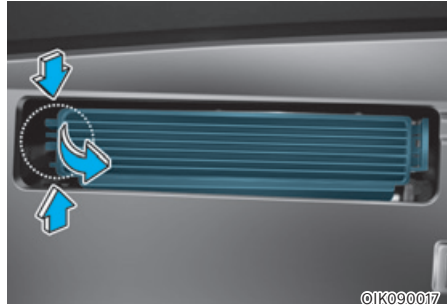

3. Press and hold the lock (1) on the left side of the cover.
4. Pull out (2) the cover
5. Replace the cabin air filter.
6. Reassemble in the reverse order of disassembly.

### NOTICE

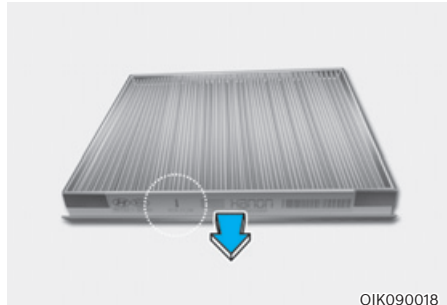

**Install a new cabin air filter in the correct direction with the arrow symbol (↓) facing downwards, to prevent noise and reduce effectiveness.**

## WIPER BLADES

### Blade Inspection

Contamination of either the windshield or the wiper blades with foreign matter can reduce the effectiveness of the windshield wipers.

Common sources of contamination are insects, tree sap, and hot wax treatments used by some commercial car washes. If the blades are not wiping properly, clean both the window and the blades with a good cleaner or mild detergent, and rinse thoroughly with clean water.

#### NOTICE

To prevent damage to the wiper blades, arms or other components, do not:

- Use gasoline, kerosene, paint thinner, or other solvents on or near them.
- Attempt to move the wipers manually.
- Use non-specified wiper blades.

#### **i** Information

Commercial hot waxes applied by automatic car washes have been known to make the windshield difficult to clean.

#### **i** Information

Wiper blades are consumable items. Normal wear of the wipers may not be covered by your vehicle warranty.

### Blade Replacement

When the wipers no longer clean the windshield adequately, the blades may be worn or cracked, and require replacement.

#### NOTICE

- In order to prevent damage to the hood and the wiper arms, the wiper arms should only be lifted when in the top wiping position.
- Always return the wiper arms to the windshield before driving.

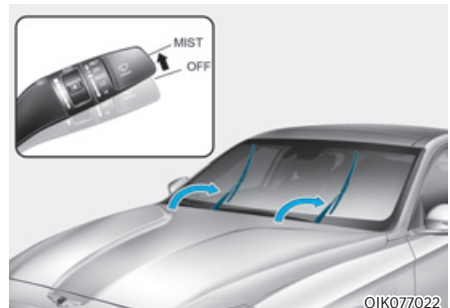

1. Within 20 seconds of turning off the engine, lift up (or push down) and hold the wiper lever to the MIST (or 1x) position for about 2 seconds until the wipers move to the top wipe position.
2. At this time you can lift the wipers off the windshield.

#### **i** Information

This vehicle has a “hidden” wiper design which means that the wipers cannot be lifted manually when they are in their bottom resting position.



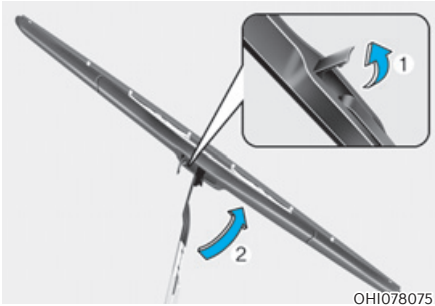

3. Lift up the wiper blade clip (1). Then lift up the wiper blade (2).

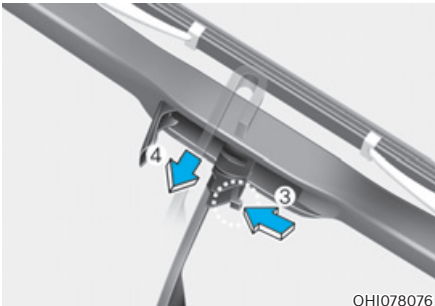

4. While pushing the lock (3), pull down the wiper blade (4).



5. Remove the wiper blade from the wiper arm (5).
6. Install a new wiper blade assembly in the reverse order of removal.
7. Gently put the wipers back down onto the windshield.
8. With the Engine Start/Stop button in the ON position, turn the wiper switch to Mist/Low/High position to return the wipers to the bottom resting position.

## BATTERY



### WARNING

To prevent **SERIOUS INJURY** or **DEATH** to you or bystanders, always follow these precautions when working near or handling the battery:



Always read and follow instructions carefully when handling a battery.



Wear eye protection designed to protect the eyes from acid splashes.



Keep all flames, sparks, or smoking materials away from the battery.



Hydrogen is always present in battery cells, is highly combustible, and may explode if ignited.



Keep batteries out of reach of children.



Batteries contain sulfuric acid which is highly corrosive. Do not allow acid to contact your eyes, skin or clothing.

If acid gets into your eyes, flush your eyes with clean water for at least 15 minutes and get immediate medical attention. If acid gets on your skin, thoroughly wash the area. If you feel pain or a burning sensation, get medical attention immediately.

- When lifting a plastic-cased battery, excessive pressure on the case may cause battery acid to leak. Lift with a battery carrier or with your hands on opposite corners.
- Do not attempt to jump start your vehicle if your battery is frozen.
- **NEVER** attempt to recharge the battery when the vehicle's battery cables are connected to the battery.
- The electrical ignition system works with high voltage. **NEVER** touch these components with the engine running or when the Engine Start/ Stop button is in the ON position.



### WARNING

#### CALIFORNIA PROPOSITION 65 WARNING

Battery posts, terminals, and related accessories contain lead and lead compounds, chemicals known to the State of California to cause cancer, birth defects and reproductive harm. Batteries also contain other chemicals known to the State of California to cause cancer. Wash hands after handling.

### NOTICE

- When you do not use the vehicle for a long time in a low temperature area, disconnect the battery and keep it indoors.
- Always charge the battery fully to prevent battery case damage in low temperature areas.

### NOTICE

If you connect unauthorized electronic devices to the battery, the battery may be discharged. Never use unauthorized devices.

## Battery Usage Recommendations

- Keep the battery securely mounted.
- Keep the battery top clean and dry.
- Keep the terminals and connections clean, tight, and coated with petroleum jelly or terminal grease.
- Rinse any spilled electrolyte from the battery immediately with a solution of water and baking soda.
- If the vehicle is not going to be used for an extended time, disconnect the battery cables.

## Battery Replacement



When replacing the battery, disconnect the negative (-) cable (1) and remove the positive (+) battery fuse box (2). Remove the trunk panel and spare wheel. Place the spare wheel on the floor with the finished side up so as not to damage. Then remove the spare wheel bracket (3) followed by the battery hold down mounting bracket (4).

### WARNING



**Do not touch the vehicle's lower area of the trunk when the engine is running or hot. It may cause serious injury. Turn the engine OFF and wait until the area is cooled before replacing the battery.**

## Battery Recharging

### **By battery charger**

Should your vehicle's battery become discharged either run the engine for at least 60 minutes driving or at idle. Alternatively you may connect a fully automatic regulated charger to the engine compartment front jumper posts or at the battery in the trunk.

### CAUTION

**Do not use a manual unregulated charger it may cause the battery to overheat and create a potential hazard.**

### WARNING

**Always follow these instructions when recharging your vehicle's battery to avoid the risk of SERIOUS INJURY or DEATH from explosions or acid burns:**

- Before performing maintenance or recharging the battery, turn off all accessories and stop the engine.
- Keep all flames, sparks, or smoking materials away from the battery.
- Always work outdoors or in an area with plenty of ventilation.
- Wear eye protection when checking the battery during charging.
- The battery must be removed from the vehicle and placed in a well ventilated area.
- Watch the battery during charging, and stop or reduce the charging rate if the battery cells begin boiling violently.

- The negative battery cable must be removed first and installed last when the battery is disconnected. Disconnect the battery charger in the following order:
  1. Turn off the main battery charger switch.
  2. Unhook the negative clamp from the negative battery terminal.
  3. Unhook the positive clamp from the positive battery terminal.
- Always use a Genuine Genesis Part approved battery when you replace the battery.

### NOTICE

#### AGM battery

- Absorbent Glass Matt (AGM) batteries are maintenance-free and we recommend that the AGM battery be serviced by an authorized retailer of Genesis Branded products. For charging your AGM battery, use only fully automatic battery chargers that are specially developed for AGM batteries.
- When replacing the AGM battery, we recommend that you use parts for replacement from an authorized retailer of Genesis Branded products.
- Do not open or remove the cap on top of the battery. This may cause leaks of internal electrolyte that could result in severe injury.

#### By jump starting

After a jump start from a good battery, drive the vehicle for 20-30 minutes before it is shutoff. The vehicle may not restart if you shut it off before the battery had a chance to adequately recharge. See “Jump Starting” in chapter 8 for more information on jump starting procedures.

#### Information



An inappropriately disposed battery can be harmful to the environment and human health. Dispose of the battery according to your local law(s) or regulation.

#### Reset Items

The following items may need to be reset after the battery has been discharged or the battery has been disconnected.

- Fuel economy/Driving info/Since refueling/Accumulated info (see chapter 4)
- Integrated memory system (see chapter 5)
- Power window (see chapter 5)
- Sunroof (see chapter 5)
- Power trunk (see chapter 5)
- Climate control system (see chapter 5)
- Clock (see Infotainment system manual)
- Infotainment system (see Infotainment system manual)

## TIRES AND WHEELS



### WARNING

Tire failure may cause loss of vehicle control resulting in an accident. To reduce risk of **SERIOUS INJURY** or **DEATH**, take the following precautions:

- Inspect your tires monthly for proper inflation as well as wear and damage.
- The recommended cold tire pressure for your vehicle can be found in this manual and on the tire label located on the driver's side center pillar. Always use a tire pressure gauge to measure tire pressure. Tires with too much or too little pressure wear unevenly causing poor handling.
- Check the pressure of the spare every time you check the pressure of the other tires on your vehicle.
- Replace tires that are worn, show uneven wear, or are damaged. Worn tires can cause loss of braking effectiveness, steering control, or traction.
- **ALWAYS** replace tires with the same size, type, construction and tread pattern as each tire that was originally supplied with this vehicle. Using tires and wheels other than the recommended sizes could cause unusual handling characteristics, poor vehicle control, or negatively affect your vehicle's Anti-Lock Brake System (ABS) resulting in a serious accident.

### Tire Care

For proper maintenance, safety, and maximum fuel economy, you must always maintain recommended tire inflation pressures and stay within the load limits and weight distribution recommended for your vehicle.



OIK087002L

All specifications (sizes and pressures) can be found on a label attached to the driver's side center pillar.

### Recommended Cold Tire Inflation Pressures

All tire pressures (including the spare) should be checked when the tires are cold. "Cold tires" means the vehicle has not been driven for at least three hours or driven less than one mile (1.6 km).

Warm tires normally exceed recommended cold tire pressures by 4 to 6 psi (28 to 41 kPa). Do not release air from warm tires to adjust the pressure or the tires will be under-inflated. For recommended inflation pressure, refer to "Tire and Wheels" section in chapter 2.



## WARNING

**Recommended pressures must be maintained for the best ride, vehicle handling, and minimum tire wear.**

**Over-inflation or under-inflation can reduce tire life, adversely affect vehicle handling, and lead to sudden tire failure that could result in loss of vehicle control resulting in an accident.**

**Severe under-inflation can lead to severe heat build-up, causing blowouts, tread separation and other tire failures that can result in the loss of vehicle control resulting in an accident. This risk is much higher on hot days and when driving for long periods at high speeds.**



## CAUTION

- **Under-inflation results in excessive wear, poor handling and reduced fuel economy. Wheel deformation is also possible. Keep your tire pressures at the proper levels. If a tire frequently needs refilling, have it checked by an authorized retailer of Genesis Branded products.**
- **Over-inflation produces a harsh ride, excessive wear at the center of the tire tread, and a greater possibility of damage from road hazards.**

## Check tire Inflation Pressure

Check your tires including the spare tire once a month or more.

### *How to check*

Use a good quality tire pressure gauge to check tire pressure. You can not tell if your tires are properly inflated simply by looking at them. Radial tires may look properly inflated even when they are under-inflated.

Remove the valve cap from the tire valve stem. Press the tire gauge firmly onto the valve to get a pressure measurement. If the cold tire inflation pressure matches the recommended pressure on the tire and loading information label, no further adjustment is necessary. If the pressure is low, add air until you reach the recommended pressure. Make sure to put the valve caps back on the valve stems. Without the valve cap, dirt or moisture could get into the valve core and cause air leakage. If a valve cap is missing, install a new one as soon as possible.

If you overfill the tire, release air by pushing on the metal stem in the center of the tire valve. Recheck the tire pressure with the tire gauge. Be sure to put the valve caps back on the valve stems. Without the valve cap, dirt or moisture could get into the valve core and cause air leakage. If a valve cap is missing, install a new one as soon as possible.

### Tire Rotation

To equalize tread wear, Genesis Branded Vehicle recommends that the tires be rotated according to the maintenance schedule or sooner if irregular wear develops.

During rotation, check the tires for correct balance.

When rotating tires, check for uneven wear and damage. Abnormal wear is usually caused by incorrect tire pressure, improper wheel alignment, out-of-balance wheels, severe braking or severe cornering. Look for bumps or bulges in the tread or side of the tire. Replace the tire if you find any of these conditions. Replace the tire if fabric or cord is visible. After rotation, be sure to bring the front and rear tire pressures to specification and check wheel lug nuts tightness (proper torque is 79~94 lbf·ft [11~13 kgf·m]).

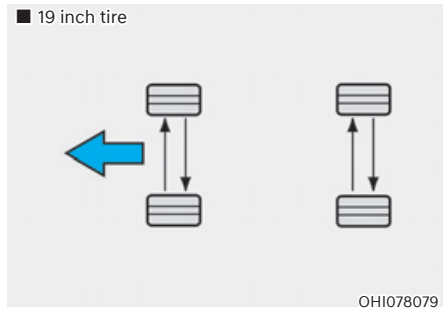
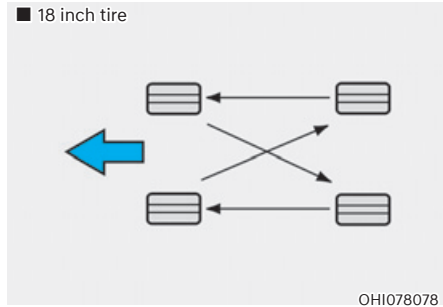

Disc brake pads should be inspected for wear whenever tires are rotated.

### **i** Information

The outside and inside of the unsymmetrical tire is distinguishable. When installing an unsymmetrical tire, be sure to install the side marked “outside” face the outside. If the side marked “inside” is installed on the outside, it will have a negative effect on vehicle performance.

### **!** WARNING

- Do not use the compact spare tire for tire rotation.
- Do not mix bias ply and radial ply tires under any circumstances. This may cause unusual handling characteristics that may cause loss of vehicle control resulting in an accident.

## Wheel Alignment and Tire Balance

The wheels on your vehicle were aligned and balanced carefully at the factory to give you the longest tire life and best overall performance.

In most cases, you will not need to have your wheels aligned again. However, if you notice unusual tire wear or your vehicle pulling one way or the other, the alignment may need to be reset.

If you notice your vehicle vibrating when driving on a smooth road, your wheels may need to be rebalanced.

### NOTICE

**Incorrect wheel weights can damage your vehicle's aluminum wheels. Use only approved wheel weights.**

## Tire Replacement



If the tire is worn evenly, a tread wear indicator will appear as a solid band across the tread. This shows there is less than 1/16 inch (1.6 mm) of tread left on the tire. Replace the tire when this happens.

Do not wait for the band to appear across the entire tread before replacing the tire.



### WARNING

**To reduce the risk of DEATH or SERIOUS INJURY:**

- **Replace tires that are worn, show uneven wear, or are damaged. Worn tires can cause loss of braking effectiveness, steering control, and traction.**
- **Always replace tires with the same size as each tire that was originally supplied with this vehicle. Using tires and wheels other than the recommended sizes could cause unusual handling characteristics, poor vehicle control, or negatively affect your vehicle's Anti-Lock Brake System (ABS) resulting in a serious accident.**
- **When replacing tires (or wheels), it is recommended to replace the two front or two rear tires (or wheels) as a pair. Replacing just one tire can seriously affect your vehicle's handling.**
- **Tires degrade over time, even when they are not being used. Regardless of the remaining tread, Genesis Branded Vehicle recommends that tires be replaced after six (6) years of normal service.**
- **Heat caused by hot climates or frequent high loading conditions can accelerate the aging process. Failure to follow this warning may cause sudden tire failure, which could lead to a loss of vehicle control resulting in an accident.**



### **Compact spare tire replacement**

A compact spare tire has a shorter tread life than a regular size tire. Replace it when you can see the tread wear indicator bars on the tire. The replacement compact spare tire should be the same size and design tire as the one provided with your new vehicle and should be mounted on the same compact spare tire wheel. The compact spare tire is not designed to be mounted on a regular size wheel, and the compact spare tire wheel is not designed for mounting a regular size tire.



### **WARNING**

**The original tire should be repaired or replaced as soon as possible to avoid failure of the compact spare tire and loss of vehicle control resulting in an accident. The compact spare tire is for emergency use only. Do not operate your vehicle over 50 mph (80 km/h) when using the compact spare tire.**

### **Wheel Replacement**

When replacing the metal wheels for any reason, make sure the new wheels are equivalent to the original factory units in diameter, rim width and offset.

### **Tire Traction**

Tire traction can be reduced if you drive on worn tires, tires that are improperly inflated or on slippery road surfaces. Tires should be replaced when tread wear indicators appear. To reduce the possibility of losing control, slow down whenever there is rain, snow or ice on the road.

### **Tire Maintenance**

In addition to proper inflation, correct wheel alignment helps to decrease tire wear. If you find a tire is worn unevenly, have your dealer check the wheel alignment.

When you have new tires installed, make sure they are balanced. This will increase vehicle ride comfort and tire life. Additionally, a tire should always be rebalanced if it is removed from the wheel.

## Tire Sidewall Labeling

This information identifies and describes the fundamental characteristics of the tire and also provides the tire identification number (TIN) for safety standard certification. The TIN can be used to identify the tire in case of a recall.

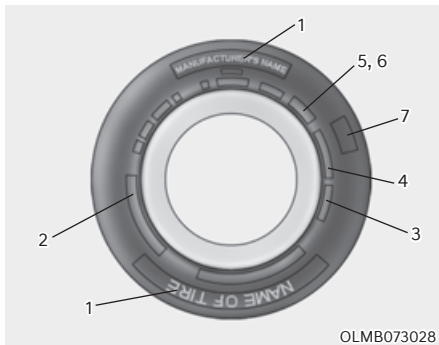

### 1. Manufacturer or brand name

Manufacturer or brand name is shown.

### 2. Tire size designation

A tire's sidewall is marked with a tire size designation. You will need this information when selecting replacement tires for your car. The following explains what the letters and numbers in the tire size designation mean.

Example tire size designation:

(These numbers are provided as an example only; your tire size designator could vary depending on your vehicle.)

### **225/45R18 95Y**

- 225 Tire width in millimeters.
- 45 Aspect ratio. The tire's section height as a percentage of its width.
- R - Tire construction code (Radial).
- 18 Rim diameter in inches.
- 95 Load Index, a numerical code associated with the maximum load the tire can carry.
- Y Speed Rating Symbol. See the speed rating chart in this section for additional information.

### Wheel size designation

Wheels are also marked with important information that you need if you ever have to replace one. The following explains what the letters and numbers in the wheel size designation mean.

Example wheel size designation:

### **8.0J X 18**

- 8.0 - Rim width in inches.
- J - Rim contour designation.
- 18 - Rim diameter in inches.

**Tire speed ratings**

The chart below lists many of the different speed ratings currently being used for passenger vehicle tires. The speed rating is part of the tire size designation on the sidewall of the tire. This symbol corresponds to that tire’s designed maximum safe operating speed.

Speed Rating Symbol	Maximum Speed
S	112 mph (180 km/h)
T	118 mph (190 km/h)
H	130 mph (210 km/h)
V	149 mph (240 km/h)
W	168 mph (270 km/h)
Y	186 mph (300 km/h)

\* Z : For tires above 149mph (240 km/h), tire manufacturers sometimes use the code “ZR”

**3. Checking tire life (TIN : Tire Identification Number)**

Any tires that are over six years old, based on the manufacturing date, (including the spare tire) should be replaced by new ones. You can find the manufacturing date on the tire sidewall (possibly on the inside of the wheel), displaying the DOT Code. The DOT Code is a series of numbers on a tire consisting of numbers and English letters. The manufacturing date is designated by the last four digits (characters) of the DOT code.

**DOT : XXXX XXXX 0000**

The front part of the DOT shows a plant code number, tire size and tread pattern and the last four numbers indicate week and year manufactured.

For example:

DOT XXXX XXXX 1521 represents that the tire was produced in the 15th week of 2021.

**4. Tire ply composition and material**

The number of layers or plies of rubber-coated fabric in the tire. Tire manufacturers also must indicate the materials in the tire, which include steel, nylon, polyester, and others. The letter “R” means radial ply construction; the letter “D” means diagonal or bias ply construction; and the letter “B” means belted-bias ply construction.

**5. Maximum permissible inflation pressure**

This number is the greatest amount of air pressure that should be put in the tire. Do not exceed the maximum permissible inflation pressure. Refer to the Tire and Loading Information label for recommended inflation pressure.

**6. Maximum load rating**

This number indicates the maximum load in kilograms and pounds that can be carried by the tire. When replacing the tires on the vehicle, always use a tire that has the same load rating as the factory installed tire.

## 7. Uniform tire quality grading

Quality grades can be found where applicable on the tire sidewall between tread shoulder and maximum section width.

For example:

TREADWEAR 200

TRACTION AA

TEMPERATURE A

### Tread wear

The tread wear grade is a comparative rating based on the wear rate of the tire when tested under controlled conditions on a specified government test course. For example, a tire graded 150 would wear one-and-a-half times (1½) as well on the government course as a tire graded 100.

The relative performance of tires depends upon the actual conditions of their use, however, and may depart significantly from the norm due to variations in driving habits, service practices and differences in road characteristics and climate.

These grades are molded on the sidewalls of passenger vehicle tires. The tires available as standard or optional equipment on your vehicle may vary with respect to grade.

### Traction - AA, A, B & C

The traction grades, from highest to lowest, are AA, A, B and C. Those grades represent the tire's ability to stop on wet pavement as measured under controlled conditions on specified government test surfaces of asphalt and concrete. A tire marked C may have poor traction performance.



### WARNING

**The traction grade assigned to this tire is based on straight ahead braking traction tests, and does not include acceleration, cornering, hydroplaning, or peak traction characteristics.**

### Temperature - A, B & C

The temperature grades are A (the highest), B and C representing the tire's resistance to the generation of heat and its ability to dissipate heat when tested under controlled conditions on a specified indoor laboratory test wheel.

Sustained high temperature can cause the material of the tire to degenerate and reduce tire life, and excessive temperature can lead to sudden tire failure. Grades B and A represent higher levels of performance on the laboratory test wheel than the minimum required by law.



## **WARNING**

The temperature grade for this tire is established for a tire that is properly inflated and not overloaded.

Excessive speed, under-inflation, over-inflation, or excessive loading, either separately or in combination, can cause heat build-up and possible sudden tire failure. This may cause loss of vehicle control resulting in an accident.

## **Tire Terminology and Definitions**

### ***Air pressure***

The amount of air inside the tire pressing outward on the tire. Air pressure is expressed in pounds per square inch (psi) or kilopascal (kPa).

### ***Accessory weight***

This means the combined weight of optional accessories. Some examples of optional accessories are automatic transmission, power seats, and air conditioning.

### ***Aspect ratio***

The relationship of a tire's height to its width.

### ***Belt***

A rubber coated layer of cords that is located between the plies and the tread. Cords may be made from steel or other reinforcing materials.

### ***Bead***

The tire bead contains steel wires wrapped by steel cords that hold the tire onto the rim.

### ***Bias ply tire***

A pneumatic tire in which the plies are laid at alternate angles less than 90 degrees to the centerline of the tread.

### ***Cold tire pressure***

The amount of air pressure in a tire, measured in pounds per square inch (psi) or kilopascals (kPa) before a tire has built up heat from driving.

### ***Curb weight***

This means the weight of a motor vehicle with standard and optional equipment including the maximum capacity of fuel, oil and coolant, but without passengers and cargo.

### ***DOT markings***

A code molded into the sidewall of a tire signifying that the tire is in compliance with the U.S. Department of Transportation motor vehicle safety standards. The DOT code includes the Tire Identification Number (TIN), an alphanumeric designator which can also identify the tire manufacturer, production plant, brand and date of production.

### ***GVWR***

Gross Vehicle Weight Rating

### ***GAWR FRT***

Gross Axle Weight Rating for the Front Axle.

### ***GAWR RR***

Gross Axle Weight Rating for the Rear axle.

***Intended outboard sidewall***

The side of an asymmetrical tire, that must always face outward when mounted on a vehicle.

***Kilopascal (kPa)***

The metric unit for air pressure.

***Light Truck (LT) tire***

A tire designated by its manufacturer as primarily intended for use on lightweight trucks or multipurpose passenger vehicles.

***Load ratings***

The maximum load that a tire is rated to carry for a given inflation pressure.

***Load index***

An assigned number ranging from 1 to 279 that corresponds to the load carrying capacity of a tire.

***Maximum inflation pressure***

The maximum air pressure to which a cold tire may be inflated. The maximum air pressure is molded onto the sidewall.

***Maximum load rating***

The load rating for a tire at the maximum permissible inflation pressure for that tire.

***Maximum loaded vehicle weight***

The sum of curb weight; accessory weight; vehicle capacity weight; and production options weight.

***Normal occupant weight***

The number of occupants a vehicle is designed to seat multiplied by 150 pounds (68 kg).

***Occupant distribution***

Designated seating positions.

***Outward facing sidewall***

An asymmetrical tire has a particular side that faces outward when mounted on a vehicle. The outward facing sidewall bears white lettering or bears manufacturer, brand, and/or model name molding that is higher or deeper than the same moldings on the inner facing sidewall.

***Passenger (P-Metric) tire***

A tire used on passenger cars and some light duty trucks and multipurpose vehicles.

***Ply***

A layer of rubber-coated parallel cords.

### ***Pneumatic tire***

A mechanical device made of rubber, chemicals, fabric and steel or other materials, that, when mounted on an automotive wheel provides the traction and contains the gas or fluid that sustains the load.

### ***Pneumatic options weight***

The combined weight of installed regular production options weighing over 5 lb. (2.3 kg) in excess of the standard items which they replace, not previously considered in curb weight or accessory weight, including heavy duty breaks, ride levelers, roof rack, heavy duty battery, and special trim.

### ***Recommended inflation pressure***

Vehicle manufacturer's recommended tire inflation pressure as shown on the tire placard.

### ***Radial ply tire***

A pneumatic tire in which the ply cords that extend to the beads are laid at 90 degrees to the centerline of the tread.

### ***Rim***

A metal support for a tire and upon which the tire beads are seated.

### ***Sidewall***

The portion of a tire between the tread and the bead.

### ***Speed rating***

An alphanumeric code assigned to a tire indicating the maximum speed at which a tire can operate.

### ***Traction***

The friction between the tire and the road surface. The amount of grip provided.

### ***Tread***

The portion of a tire that comes into contact with the road.

### ***Treadwear indicators***

Narrow bands, sometimes called "wear bars", that show across the tread of a tire when only 1/16 inch of tread remains.

### ***UTQGS***

Uniform Tire Quality Grading Standards is a tire information system that provides consumers with ratings for a tire's traction, temperature and treadwear. Ratings are determined by tire manufacturers using government testing procedures. The ratings are molded into the sidewall of the tire.

### ***Vehicle capacity weight***

The number of designated seating positions multiplied by 150 lbs. (68 kg) plus the rated cargo and luggage load.

### ***Vehicle maximum load on the tire***

Load on an individual tire due to curb and accessory weight plus maximum occupant and cargo weight.

### ***Vehicle normal load on the tire***

Load on an individual tire that is determined by distributing to each axle its share of the curb weight, accessory weight, and normal occupant weight and dividing by 2.

### **Vehicle placard**

A label permanently attached to a vehicle showing the original equipment tire size and recommended inflation pressure.

### **All Season Tires**

Genesis Branded Vehicle specifies all season tires on some models to provide good performance for use all year round, including snowy and icy road conditions. All season tires are identified by ALL SEASON and/or M+S (Mud and Snow) on the tire sidewall. Snow tires have better snow traction than all season tires and may be more appropriate in some areas.

### **Summer Tires**

Genesis Branded Vehicle specifies summer tires on some models to provide superior performance on dry roads. Summer tire performance is substantially reduced in snow and ice. Summer tires do not have the tire traction rating M+S (Mud and Snow) on the tire side wall. If you plan to operate your vehicle in snowy or icy conditions, Genesis Branded Vehicle recommends the use of snow tires or all season tires on all four wheels.

### **Snow Tires**

If you equip your car with snow tires, they should be the same size and have the same load capacity as the original tires. Snow tires should be installed on all four wheels; otherwise, poor handling may result. Snow tires should carry 4 psi (28 kPa) more air pressure than the pressure recommended for the standard tires on the tire label on the driver's side of the center pillar, or up to the maximum pressure shown on the tire sidewall, whichever is less. Do not drive faster than 75 mph (120 km/h) when your vehicle is equipped with snow tires.

### **Radial-Ply Tires**

Radial-ply tires provide improved tread life, road hazard resistance and smoother high speed ride. The radial-ply tires used on this vehicle are of belted construction, and are selected to complement the ride and handling characteristics of your vehicle. Radial-ply tires have the same load carrying capacity, as bias-ply or bias belted tires of the same size, and use the same recommended inflation pressure. Mixing of radial-ply tires with bias-ply or bias belted tires is not recommended. Any combinations of radial-ply and bias-ply or bias belted tires when used on the same vehicle will seriously deteriorate vehicle handling. The best rule to follow is: Identical pairs of radial-ply tires should always be used as a set for the front tires and a set for the rear tires.



Longer wearing tires can be more susceptible to irregular tread wear. It is very important to follow the tire rotation interval in this chapter to achieve the tread life potential of these tires. Cuts and punctures in radial-ply tires are repairable only in the tread area, because of sidewall flexing. Consult your tire dealer for radial-ply tire repairs.

 **WARNING**

**Do not mix bias ply and radial ply tires under any circumstances. This may cause unusual handling characteristics that may cause loss of vehicle control resulting in an accident.**

**Low Aspect Ratio Tires**

The aspect ratio is lower than 50 on low aspect ratio tires.

Because low aspect ratio tires are optimized for handling and braking, their sidewall is a little stiffer than a standard tire. Also, low aspect ratio tires tend to be wider so that they consequently have a greater contact patch with the road surface. In some instances, they may generate more road noise compared with standard tires.

 **CAUTION**

**The side wall of a low aspect ratio tire is shorter than the normal one. Thus, the low-aspect wheel and tire are easily damaged. Follow the below instructions.**

- **When driving on a rough road or driving off a road, be careful not to damage the tires and wheels. After driving, inspect the tires and wheels.**
- **When passing over a pothole, speed bump, manhole, or curb stone, drive the vehicle slowly so as not to damage the tires and wheels.**
- **When there is an impact on a tire, inspect the tire condition. Or, contact an authorized retailer of Genesis Branded products.**
- **Inspect the tire condition and pressure every 1,800 miles (3,000 km) to prevent tire damage.**
- **It is difficult to recognize a tire damage only with your eyes. When there is a slight hint of a tire damage, check and replace the tire to prevent the damage caused by air leakage.**
- **When a tire is damaged while driving on a rough road, off a road, or over obstacles, such as a pothole, manhole, or curb stone, your warranty does not cover the damage.**
- **The tire information is specified on the tire side wall.**

## FUSES

### ■ Blade type



Normal



Blown

### ■ Cartridge type



Normal



Blown

### ■ Multi type

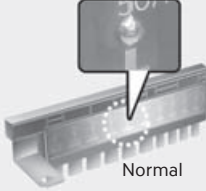

Normal

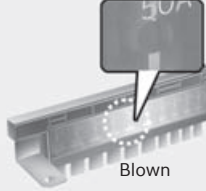

Blown

### ■ Midi type



Normal



Blown

OCK077071

A vehicle's electrical system is protected from electrical overload damage by fuses.

This vehicle has 5 fuse panels, one located in the driver's side panel bolster, the other in the engine compartment.

If any of your vehicle's lights, accessories, or controls do not work, check the appropriate circuit fuse. If a fuse has blown, the element inside the fuse will be melted or broken.

If the electrical system does not work, first check the driver's side fuse panel. Before replacing a blown fuse, turn the engine and all switches off, and then disconnect the negative battery cable. Always replace a blown fuse with one of the same rating.

If the replacement fuse blows, this indicates an electrical problem. Avoid using the system involved and immediately consult an authorized retailer of Genesis Branded products.



### WARNING

**NEVER** replace a fuse with anything but another fuse of the same rating.

- A higher capacity fuse could cause damage and possibly cause a fire.
- Do not install a wire or aluminum foil instead of the proper fuse - even as a temporary repair. It may cause extensive wiring damage and possibly a fire.

### NOTICE

Do not use a screwdriver or any other metal object to remove fuses because it may cause a short circuit and damage the system.

## Instrument Panel Fuse Replacement

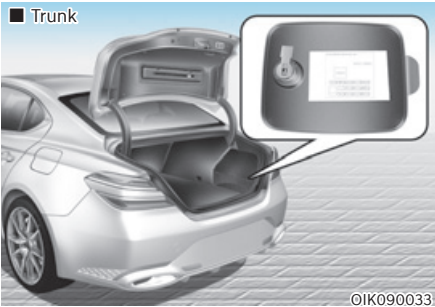

1. Turn the vehicle off.
2. Turn all other switches off.
3. Open the fuse panel cover.
4. Refer to the label on the inside of the fuse panel cover to locate the suspected broken fuse location.

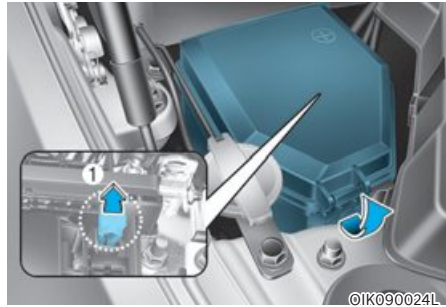

5. Pull the suspected fuse straight out. Use the removal tool (1) provided in the engine compartment fuses panel cover.
6. Check the removed fuse; replace it if it is blown. Spare fuses are provided in the instrument panel fuse panels (or in the engine compartment fuse panel).
7. Push in a new fuse of the same rating, and make sure it fits tightly in the clips. If it fits loosely, consult an authorized retailer of Genesis Branded products.

In an emergency, if you do not have a spare fuse, use a fuse of the same rating from a circuit such as the cigarette lighter fuse.

If the headlamps or other electrical components do not work and the fuses are undamaged, check the fuse panel in the engine compartment. If a fuse is blown, it must be replaced with the same rating.

## Engine Compartment Panel Fuse Replacement

### Blade fuse / Cartridge fuse

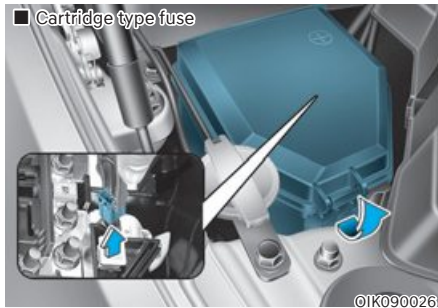
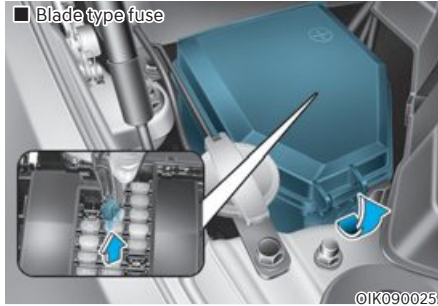

1. Turn the vehicle off.
2. Turn all other switches off.
3. Remove the fuse panel cover by pressing the tap and pulling up.
4. Check the removed fuse; replace it if it is blown. To remove or insert the fuse, use the fuse puller in the engine compartment fuse panel.
5. Push in a new fuse of the same rating, and make sure it fits tightly in the clips. If it does not fit tightly, consult an authorized retailer of Genesis Branded products.

### NOTICE

After checking the fuse panel in the engine compartment, securely install the fuse panel cover. You may hear a clicking sound if the cover is securely latched. If it is not securely latched, electrical failure may occur from water contact.

### Multi fuse / Midi fuse

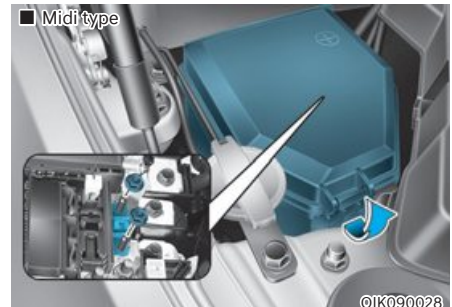
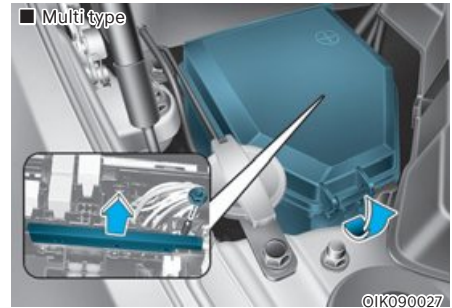

If the multi fuse or midi fuse is blown, consult an authorized retailer of Genesis Branded products.

## Fuse/Relay Panel Description

### Instrument panel fuse panel



Inside the fuse/relay box cover, you can find the fuse/relay label describing fuse/relay names and ratings.

## **i** Information

Not all fuse panel descriptions in this manual may be applicable to your vehicle; the information is accurate at the time of printing. When you inspect the fuse box on your vehicle, refer to the fuse box label.

91941-G9060

USE THE DESIGNATED FUSE ONLY  
UTILISEZ SEULEMENT LE FUSIBLE  
DÉSIGNÉS

	<sup>1</sup> MULTI MEDIA 20A	<sup>1</sup> AIR BAG 15A	INTERIOR LAMP 10A	STOP LAMP 10A	CLUSTER 10A		<sup>2</sup> E-SHIFTER 10A		<sup>3</sup> IBU 10A	
<sup>3</sup> MULTI MEDIA 10A	<sup>2</sup> MULTI MEDIA 15A	<sup>1</sup> MEMORY 10A	<sup>4</sup> IBU 10A				<sup>1</sup> E-SHIFTER 10A	<sup>1A</sup> 10A	<sup>3</sup> A/BAS IND 10A	
	<sup>1</sup> IBU 15A	DOM 10A						<sup>2</sup> MODULE 10A	<sup>3</sup> MODULE 10A	
DOOR LOCK 20A	S/HEATER DRV/PASSE 25A	TRUNK OPEN 10A	IBU 10A				<sup>2</sup> AIR BAG 15A	<sup>1</sup> POWER OUTLET 20A	<sup>6</sup> MODULE 10A	<sup>7</sup> MODULE 10A
POWER HANDLE 15A		<sup>8</sup> MODULE 10A					<sup>1</sup> MODULE 10A	CHARGER 10A	<sup>3</sup> MODULE 10A	
SUNROOF 20A		P/WINDOW RH 25A						<sup>2</sup> POWER OUTLET 20A	WASHER 15A	MCPS 10A
P/SEAT (DRV) 30A	P/SEAT (PASS) 30A	P/WINDOW LH 25A						<sup>9</sup> MODULE 10A	A/C 10A	<sup>4</sup> MODULE 10A

FUSE SWITCH

OIK090117N

**Instrument panel (Driver's side fuse panel)**

Fuse Name	Fuse Rating	Circuit Protected
MULTI MEDIA1	20A	[W/O ISG] Fuse - F11, F12 [With ISG] Low DC-DC Converter (Audio)
AIR BAG1	15A	SRS Control Module
ROOM LAMP	10A	Overhead Console Lamp, Center Room Lamp, Room Lamp Vanity Lamp Switch LH/RH, Luggage Lamp LH/RH Glove Box Lamp, Driver/Passenger Foot Lamp
STOP LAMP	10A	IBU, Stop Lamp Switch
CLUSTER	10A	Instrument Cluster, Head-Up Display
E-SHIFTER2	10A	Electronic ATM Shift Lever
IBU3	10A	IBU
MULTI MEDIA3	10A	[With ISG] Instrument Cluster, Head-Up Display, A/C Switch Front Wireless Charger, Around View Monitor [W/O ISG] Around View Monitor
MULTI MEDIA2	15A	Audio
MEMORY1	10A	A/C Control Module, A/C Switch, Security Indicator Head-Up Display, Power Tail Gate Unit, Power Trunk Module [W/O ISG] Instrument Cluster
IBU4	10A	IBU
E-SHIFTER1	10A	Electronic ATM Shift Lever
AIR BAG IND.	10A	Instrument Cluster, Overhead Console Lamp
IBU1	15A	IBU, Driver/Passenger Smart Key Outside Handle, Driver/Passenger Power Outside Mirror
DRIVER DR MODULE	10A	Driver Door Module, Driver/Passenger Power Outside Mirror
E-CALL	10A	Emergency Call Module
MODULE2	10A	IBU
MODULE3	10A	Driver Door Module, Stop Lamp Switch

Fuse Name	Fuse Rating	Circuit Protected
DOOR LOCK	20A	Door Lock Relay, Door Unlock Relay, Dead Lock Relay
SEAT HEATER	25A	Front Air Ventilation Seat Control Module Front Seat Warmer Control Module
TRUNK	10A	Trunk Lid Relay, Fuel Lid Relay, Crash Pad Switch
IBU2	10A	IBU, Rain Sensor
AIR BAG2	15A	SRS Control Module
POWER OUTLET1	20A	Front Power Outlet
MODULE8	10A	Cooling Fan Controller (BLDC Motor)
MODULE7	10A	Dosing Control Module, AWD ECM, Active Air Flap LH, ECS Unit, Smart Cruise Control Module, Console Switch, Crash Pad Switch, IBU, Console Switch, Multi-Function Camera Unit, Front Wireless Charger, Steering Tilt & Telescopic Module, Around View Monitor, Electronic Control Engine Mounting Module, Steering Angle Sensor
POWER HANDLE	15A	Steering Tilt & Telescopic Module
MODULE9	10A	Driver Air Lumbar Control Unit
MODULE1	10A	Data Link Connector, Console Switch, Hazard Switch, Electronic Control Engine Mounting Module
CHARGER	10A	Front/Rear USB Charger, Front Tray USB Charger
MODULE5	10A	A/C Control Module, A/C Switch, A/V & Navigation Head Unit, Low DC-DC Converter (Audio/AMP), Electro Chromic Mirror, AMP, Emergency Module, Driver IMS Control Module, Front Air Ventilation Seat Control Module, Data Link Connector, Front/Rear Seat Warmer Control Module, IFS Module
SUNROOF	20A	Sunroof Control Unit (Glass)
PASSENGER P/ WINDOW	25A	Passenger Safety Power Window Module, Rear Power Window Switch RH, Rear Safety Power Window Module RH
POWER OUTLET2	20A	[5DR] Rear Power Outlet

Fuse Name	Fuse Rating	Circuit Protected
WASHER	15A	Multifunction Switch
MDPS	10A	MDPS Unit
DRIVER P/SEAT	30A	Driver IMS Control Module, Driver Seat Manual Switch
PASSENGER P/SEAT	30A	Passenger Seat Manual Switch, Passenger Walk In Relay Module
DRIVER P/WINDOW	25A	Driver Safety Power Window Module, Rear Safety Power Window Module LH, Rear Power Window Switch LH
MODULE6	10A	Around View Monitor, IBU, Emergency Call Module, AMP, Electronic ATM Shift Lever, Overhead Console Lamp, A/V & Navigation Head Unit, Low DC-DC Converter (Audio/AMP)
A/CON	10A	A/C Control Module, A/C Switch, PM Sensor (A/C), E/R Junction Block (RLY.6), Diesel Junction Block (RLY.3/4)
MODULE4	10A	Head Lamp LH/RH, Auto Head Lamp Leveling Device Module



**Engine compartment fuse panel  
(Engine room junction block)**

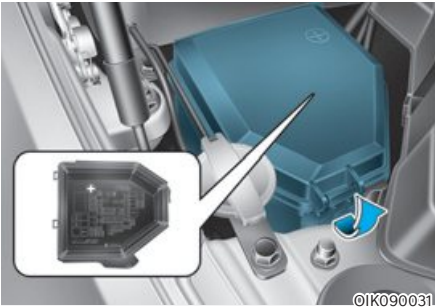

©IK090031

Inside the fuse/relay box cover, you can find the fuse/relay label describing fuse/relay names and ratings.

**i Information**

Not all fuse panel descriptions in this manual may be applicable to your vehicle; the information is accurate at the time of printing. When you inspect the fuse panel in your vehicle, refer to the fuse panel label.

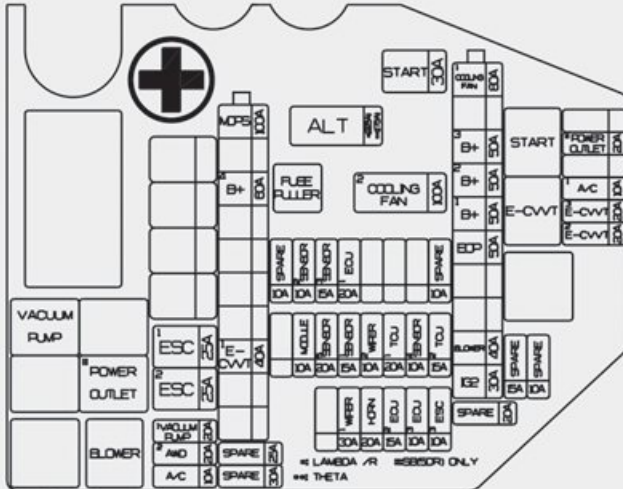

**91335-03120**  
USE THE DESIGNATED FUSE AND RELAY ONLY

OIK090116C

### Engine compartment fuse panel

Fuse Name	Fuse Rating	Circuit Protected
ALT	175A 225A	Alternator, Fuse - F2, Multi Fuse 1 - F4, F6, F7, F8, F9, F10, F11, F12, F13
C/FAN3	125A	[G6DP - BLDC Motor] Cooling Fan Controller
GLOW		[D4HB] Glow Relay Unit
START	30A	RLY. 7 (Start Relay)
C/FAN1	80A	[BLDC Motor] Cooling Fan Controller
B+3	50A	ICU Junction Block (Fuse - F5, Leak Current Autocut Device Fuse - F2, F4, F13, F14, F21, F22)
B+2	50A	ICU Junction Block (Fuse - F27, F35, F43, F51, F52)
B+1	50A	ICU Junction Block (Fuse - F28, F29, F37, F45, F53)
EOP	50A	[With ISG] Electric Oil Pump Module
ESP1	40A	ESP Control Module
ESP2	40A	ESP Control Module
BLOWER	40A	RLY. 6 (Blower Relay)
IG2	30A	PCB Block (IG2 Relay)
MDPS	100A	MDPS Unit
B+4	60A	PCB Block (Engine Control Relay, Fuse - F4, F5, F13, F22)
C/FAN2	60A	[DC Motor] RLY. 9 (Cooling Fan Relay)
E-CVVT1	40A	[G4KL] RLY. 8 (E-CVVT Relay)
TRAILER	40A	Trailer Connector
FUEL HEATER	40A	Diesel Junction Block (RLY.1 (Fuel Filter Heater Relay))
PTC HEATER1	30A	Diesel Junction Block (RLY.2 (PTC Heater #1 Relay))
PTC HEATER2	30A	Diesel Junction Block (RLY.3 (PTC Heater #2 Relay))
PTC HEATER3	30A	Diesel Junction Block (RLY.4 (PTC Heater #3 Relay))

Fuse Name	Fuse Rating	Circuit Protected
VACUUM PUMP	20A	[G4KL/G6DP] RLY. 1 (Vacuum Pump Relay)
AWD	20A	AWD ECM
A/CON	10A	A/C Control Module
E-CVVT3	20A	[G4KL] ECM
E-CVVT2	20A	[G4KL] ECM

### Engine compartment fuse panel

Fuse Name	Fuse Rating	Circuit Protected
ESC3	10A	ESP Control Module
ECU3	10A	ECM
ECU2	15A	ECM
HORN	20A	Horn Relay
WIPER1	30A	Wiper Power Relay
TCU2	15A	P/N Relay, TCM
SENSOR4	10A	Electronic Oil Pump Module, Brake Vacuum Switch, E/R Junction Block (RLY.1 (Brake Vacuum Relay))
TCU1	20A	TCM
WIPER2	10A	IBU, ECM
SENSOR1	15A	Rear Sub Junction Block (Fuel Pump Relay), [D4HB] Rail Pressure Regulating Valve, Diesel Junction Block (RLY.1 (Fuel Filter Heater Relay))
SENSOR5	20A	[G4KL] Ignition Coil #1/#2/#3/#4 [G6DP] Ignition Coil #1/#2/#3/#4/#5/#6 [D4HB] Electronic Water Pump
MODULE	10A	Active Air Flap LH
ACTIVE HOOD	10A	Active Hood Lift Control Module
SENSOR1	10A	[D4HB] Glow Relay Unit, Fuel Heater & Water Separator Sensor
ECU1	20A	ECM
SENSOR3	15A	[G4KL] Oxygen Sensor (Up/Down) [G6DP] Oxygen Sensor #1/#2/#3/#4 [D4HB] Lambda Sensor #1/#2, Electronic VGT Actuator, Fuel Metering Unit, EGR Cooling Bypass Solenoid Valve, PTC Heater, Mid Nox Sensor, PM Sensor, Rear Nox Sensor

Fuse Name	Fuse Rating	Circuit Protected
SENSOR2	10A	E/R Junction Block (RLY. 9 - Cooling Fan Relay), [G4KL] Electronic Thermostat, Oil Control Valve, Purge Control Solenoid Valve, Recirculation Control Solenoid Valve [G6DP] Electronic Thermostat, Oil Pressure Solenoid Valve, Oil Control Valve #1/#2/#3/#4 (Intake/Exhaust), Recirculation Control Solenoid Valve, Purge Control Solenoid Valve, Variable Exhaust Flap Actuator LH/RH [D4HB] Oil Pump Solenoid Valve, Air Flow Sensor, Crankshaft Position Sensor, Front Nox Sensor, Oil Level Sensor, Stop Lamp Switch
B/ALARM	10A	E/R Junction Block (RLY. 2 - Burglar Alarm Horn Relay)

Relay

Type	Relay No.	Relay Name
MICRO	RLY. 1	Vacuum OIK090033
MICRO	RLY. 2	Burglar Alarm Horn Relay
MICRO	RLY. 6	Blower Relay
MICRO	RLY. 7	Start Relay
MICRO	RLY. 8	E-CVVT Relay (G4KL)
MINI	RLY. 9	Cooling Fan Relay

### Trunk fuse panel (Rear sub junction block)



OIK090033

Inside the fuse/relay box cover, you can find the fuse/relay label describing fuse/relay names and ratings.

### **i** Information

Not all fuse panel descriptions in this manual may be applicable to your vehicle; the information is accurate at the time of printing. When you inspect the fuse panel in your vehicle, refer to the fuse panel label.

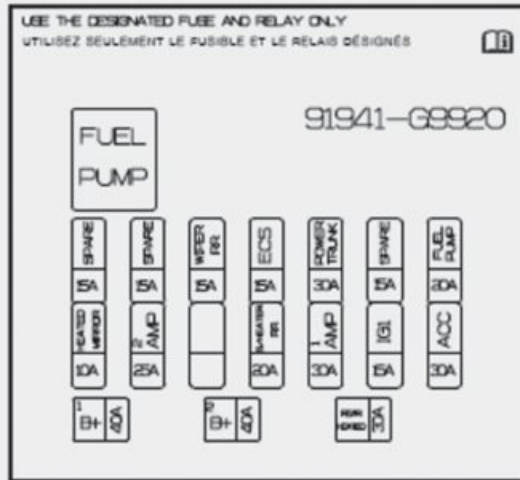

OIK090105L

Rear fuse box panel

Fuse Name	Fuse Rating	Circuit Protected
DCU2	15A	Dosing Control Module
DCU3	15A	Dosing Control Module
REAR WIPER	15A	Wipre RR Relay, Rear Wiper Motor
ECS	15A	ECS Unit
POWER TRUNK	30A	Power Trunk Module, Power Tailgate Unit
DCU1	15A	Dosing Control Module
FUEL PUMP	20A	Fuel Pump Relay
HEAT MIRROR	10A	A/C Switch, Driver/Passenger Power Outside Mirror
AMP2	25A	AMP
REAR S/HEAT	20A	Rear Seat Warmer Control Module
AMP1	30A	[W/O ISG] Fuse - F9 [With ISG] Low DC-DC Converter (AMP)
IG1	15A	PCB Block (IG1 Relay)
ACC	30A	ICU Junction Block (Fuse - F32, F40, F54)
B+1	40A	ICU Junction Block (IPS5, IPS6, IPS7, IPS8, IPS9, IPS10, Fuse - F20, 30F)
B+2	40A	ICU Junction Block (IPS1, IPS2, Fuse - F15, F39)
REAR HEATED	30A	Rear Heated Relay

## Trunk fuse panel (Battery junction block)



OIK090034

Inside the fuse/relay box cover, you can find the fuse/relay label describing fuse/relay names and ratings.

## **i** Information

Not all fuse panel descriptions in this manual may be applicable to your vehicle; the information is accurate at the time of printing. When you inspect the fuse panel in your vehicle, refer to the fuse panel label.

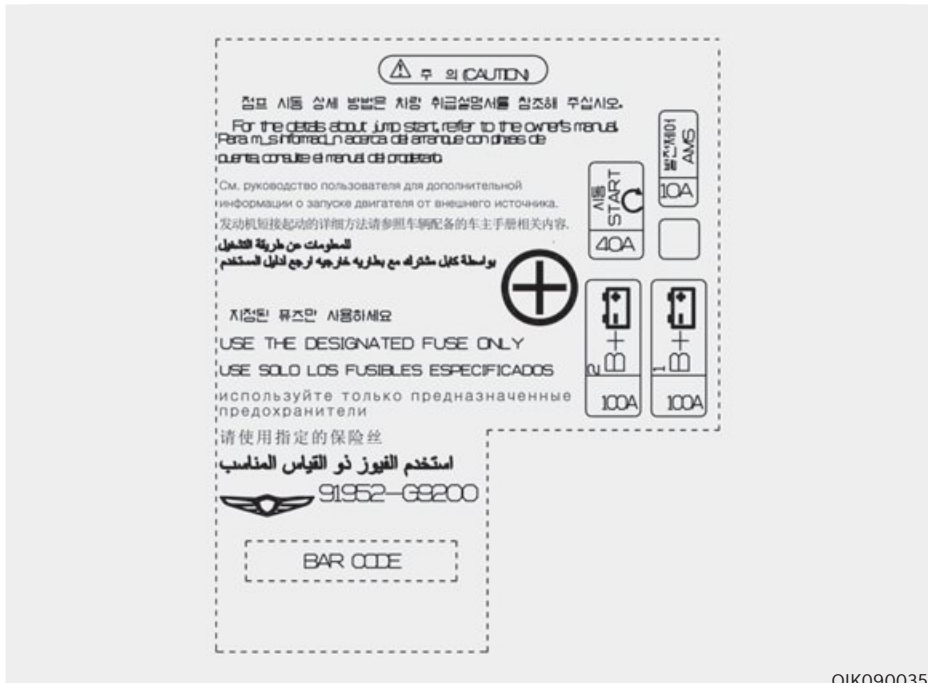

OIK090035



### Battery box fuse panel

Fuse Name	Fuse Rating	Circuit Protected
B+1	100A	Rear Sub Junction Block (ACC Relay, Fuse - F7, F12, F13, F16, F17)
B+2	100A	Rear Sub Junction Block (DCU Relay, Fuse - F3, F5, F4, F11, F15)
START	40A	E/R Junction Block (Fuse - F3), PCB Block (Fuse - F3, F9)
AMS	10A	Battery Sensor

## LIGHT BULBS

Consult an authorized retailer of Genesis Branded products to replace most vehicle light bulbs. It is difficult to replace vehicle light bulbs because other parts of the vehicle must be removed before you can get to the bulb. This is especially true for removing the headlamp assembly to get to the bulb(s).

Removing/installing the headlamp assembly can result in damage to the vehicle.



### WARNING

- Prior to working on a light, depress the foot brake, shift to P (Park), apply the parking brake, press the Engine Start/Stop button to the OFF position and take the key with you when leaving the vehicle to avoid sudden movement of the vehicle and to prevent possible electric shock.
- Be aware the bulbs may be hot and may burn your fingers.

### NOTICE

Be sure to replace the burned-out bulb with one of the same wattage rating. Otherwise, it may cause damage to the fuse or electrical wiring system.

### NOTICE

To prevent damage, do not clean the headlamp lens with chemical solvents or strong detergents.



### Information

The headlamp and tail lamp lenses could appear frosty if the vehicle is washed after driving or the vehicle is driven at night in wet weather. This condition is caused by temperature difference between the lamp inside and outside and, it does not indicate a problem with your vehicle. When moisture condenses in the lamp, it will be removed after driving with the headlamp on. The removable level may differ depending on lamp size, lamp position and environmental condition. However, if moisture is not removed, have the vehicle inspected by an authorized retailer of Genesis Branded products.



### Information

- A normally functioning lamp may flicker momentarily to stabilize the vehicle's electrical control system. However, if the lamp goes out after flickering momentarily, or continues to flicker, have the system checked by an authorized retailer of Genesis Branded products.
- The parking lamp may not turn on when the parking lamp switch is turned on, but the parking lamp and headlamp switch may turn on when the headlamp switch is turned on. This may be caused by network failure or vehicle electrical control system malfunction. If this occurs, have the system checked by an authorized retailer of Genesis Branded products.



### Information

The headlamp aiming should be adjusted after an accident or after the headlamp assembly is reinstalled at an authorized retailer of Genesis Branded products.

### Headlamp, position lamp, turn signal lamp, Daytime Running Light (DRL) replacement

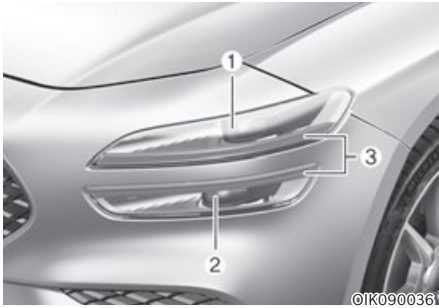

- (1) Headlamp (Low)
- (2) Headlamp (High / Sub low)
- (3) Position lamp/Daytime running light/ Turn signal lamp

If the LED lamp does not operate, have the system inspected by an authorized retailer of Genesis Branded products.

The LED lamps cannot be replaced as a single unit because it is an integrated unit. The LED lamps has to be replaced with the unit.

Unless a skilled technician checks or repairs the LED lamp, it may damage related parts of the vehicle.

### Side Repeater Lamp Replacement



If the LED lamp (1) does not operate, have the system inspected by an authorized retailer of Genesis Branded products.

The LED lamps cannot be replaced as a single unit because it is an integrated unit. The LED lamps has to be replaced with the unit.

A skilled technician should check or repair the LED lamp, for it may damage related parts of the vehicle.

## Puddle Lamp Replacement

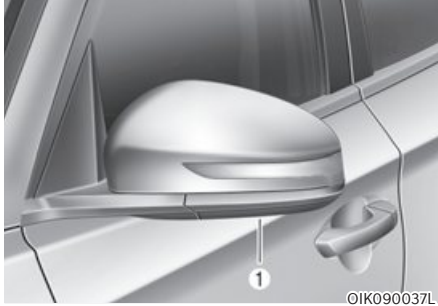

If the LED lamp (1) does not operate, have the system inspected by an authorized retailer of Genesis Branded products.

The LED lamps cannot be replaced as a single unit because it is an integrated unit. The LED lamps has to be replaced with the unit.

A skilled technician should check or repair the LED lamp, for it may damage related parts of the vehicle.

## Rear Combination Lamp Replacement

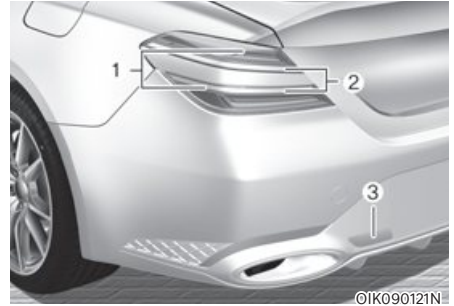

- (1) Tail lamp
- (2) Stop/Turn signal lamp
- (3) Reverse lamp

If the LED lamp does not operate, have the system inspected by an authorized retailer of Genesis Branded products.

The LED lamps cannot be replaced as a single unit because it is an integrated unit. The LED lamps has to be replaced with the unit.

Unless a skilled technician checks or repairs the LED lamp, it may damage related parts of the vehicle

## High Mounted Stop Lamp Replacement

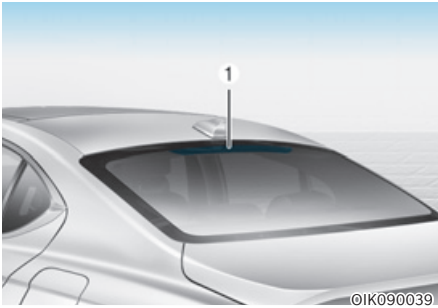

If the LED lamp (1) does not operate, have the system inspected by an authorized retailer of Genesis Branded products.

The LED lamps cannot be replaced as a single unit because it is an integrated unit. The LED lamps has to be replaced with the unit.

Unless a skilled technician checks or repairs the LED lamp, it may damage related parts of the vehicle.

## License Plate Lamp Replacement

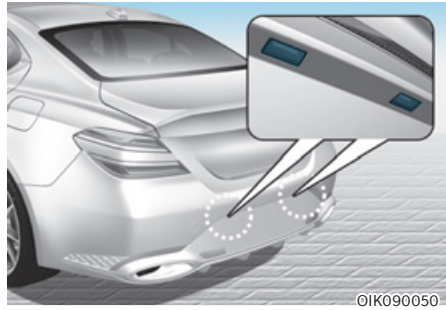

If the LED lamp does not operate, have the system inspected by an authorized retailer of Genesis Branded products.

The LED lamps cannot be replaced as a single unit because it is an integrated unit. The LED lamps has to be replaced with the unit.

Unless a skilled technician checks or repairs the LED lamp, it may damage related parts of the vehicle.

## Interior Light Replacement

### ■ Front lamps

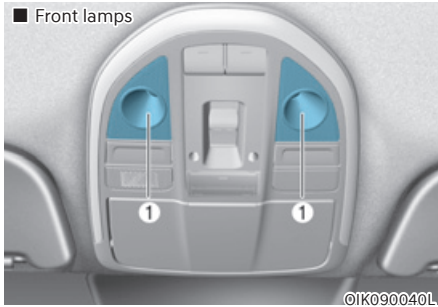

### ■ Rear lamps

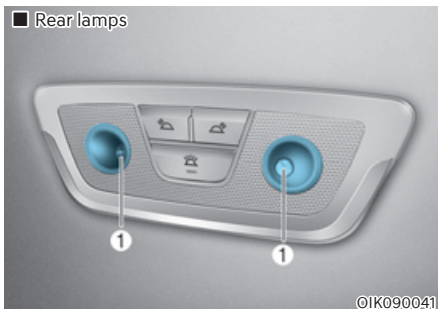

### ■ Vanity mirror lamp

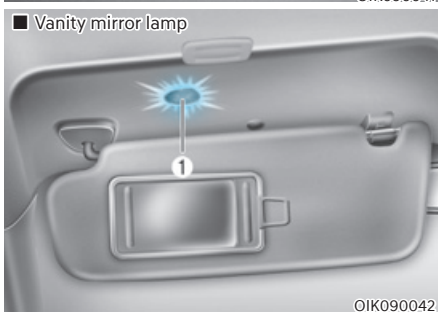

### ■ Glove box lamp

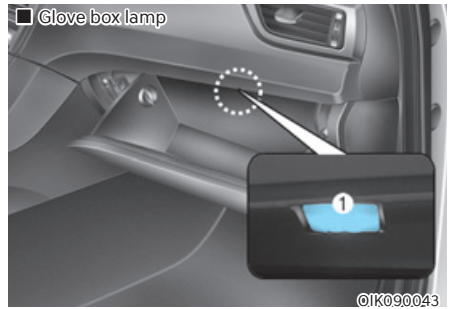

### ■ Foot lamp

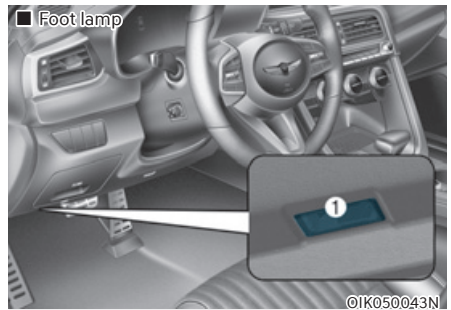

### ■ Trunk lamp

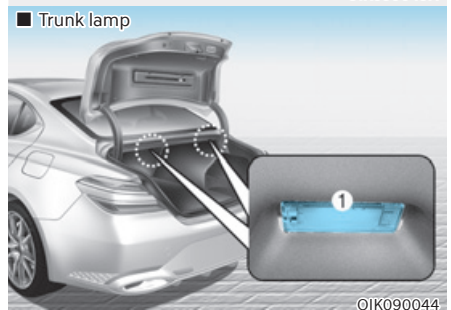

If the LED lamp (1) does not operate, have the system inspected by an authorized retailer of Genesis Branded products.

The LED lamps cannot be replaced as a single unit because it is an integrated unit. The LED lamp has to be replaced with the unit.

Unless a skilled technician checks or repairs the LED lamp, it may damage related parts of the vehicle.

## APPEARANCE CARE

### Exterior Care

#### **NOTICE**

**If you park your vehicle near a stainless steel sign or glass facade building, the vehicle's exterior plastic parts such as a bumper, spoiler, garnish, lamp or side view mirrors might be damaged due to sunlight reflected from the sign or building. To prevent damage of the exterior plastic parts, you should avoid parking in areas where light may be reflected or use a car cover. (The exterior plastic parts applied to your vehicle may vary.)**

#### ***Exterior general caution***

It is very important to follow the label directions when using any chemical cleaner or polish. Read all warning and caution statements that appear on the label.

#### ***Finish maintenance***

##### **Washing**

To help protect your vehicle's finish from rust and deterioration, wash it thoroughly and frequently at least once a month with lukewarm or cold water.

If you use your vehicle for off-road driving, you should wash it after each off-road trip. Pay special attention to the removal of any accumulation of salt, dirt, mud, and other foreign materials. Make sure the drain holes in the lower edges of the doors and rocker panels are kept clear and clean.

Insects, tar, tree sap, bird droppings, industrial pollution and similar deposits can damage your vehicle's finish if not removed immediately.

Even prompt washing with plain water may not completely remove all these deposits. A mild soap, safe for use on painted surfaces, should be used.

After washing, rinse the vehicle thoroughly with lukewarm or cold water. Do not allow soap to dry on the finish.

#### **High-pressure washing**

- When using high-pressure washers, make sure to maintain sufficient distance from the vehicle.  
Insufficient clearance or excessive pressure can lead to component damage or water penetration.
- Do not spray the camera, sensors or its surrounding area directly with a high pressure washer. Shock applied from high pressure water may cause the device to not operate normally.
- Do not bring the nozzle tip close to boots (rubber or plastic covers) or connectors as they may be damaged if they come into contact with high pressure water.



#### **WARNING**

**After washing the vehicle, test the brakes while driving slowly to see if they have been affected by water before getting on the road. If braking performance is impaired, dry the brakes by applying them lightly while maintaining a slow forward speed.**

**NOTICE**

- Do not use strong soap, chemical detergents or hot water, and do not wash the vehicle in direct sunlight or when the body of the vehicle is warm.
- Be careful when washing the side windows of your vehicle.
- Especially, with high-pressure water, water may leak through the windows and wet the interior.
- To prevent damage to the plastic parts, do not clean with chemical solvents or strong detergents.

**NOTICE**

- Water washing in the engine compartment including high pressure water washing may cause the failure of electrical circuits located in the engine compartment.
- Never allow water or other liquids to come in contact with electrical/ electronic components inside the vehicle as this may damage them.

**NOTICE****Matte paint finish vehicle**

Automatic car wash which uses rotating brushes should not be used as this can damage the surface of your vehicle. A steam cleaner which washes the vehicle surface at high temperature may cause the oil to adhere and leave stains that is difficult to remove.

Use a soft cloth (e.g. microfiber towel or sponge) when washing your vehicle and dry with a microfiber towel. When you handwash your vehicle, you should not use a cleaner that finishes with wax.

**Waxing**

A good coat of wax is a barrier between your paint and contamination. Keeping a good coat of wax on your vehicle will help protect it.

Wax the vehicle until water will no longer bead on the paint.

Always wash and dry the vehicle before waxing. Use a good quality liquid or paste wax, and follow the manufacturer's instructions. Wax all metal trim to protect it and to maintain its luster.

Removing oil, tar, and similar materials with a spot remover will usually strip the wax from the finish. Be sure to re-wax these areas even if the rest of the vehicle does not yet need waxing.



**NOTICE**

- Wiping dust or dirt off the body with a dry cloth will scratch the finish.
- Do not use steel wool, abrasive cleaners, or strong detergents containing highly alkaline or caustic agents on chrome-plated or anodized aluminum parts. This may result in damage to the protective coating and cause discoloration or paint deterioration.

**NOTICE**

**Matte paint finish vehicle**

Do not use any polish protector such as a detergent, an abrasive or a polish. In case wax is applied, remove the wax immediately using a silicon remover and if any tar or tar contaminant is on the surface, use a tar remover to clean. However, be careful not to apply too much pressure on the painted area.

***Finish damage repair***

Deep scratches or stone chips in the painted surface must be repaired promptly. Exposed metal will quickly rust and may develop into a major repair expense.

**NOTICE**

**If your vehicle is damaged and requires any metal repair or replacement, be sure the body shop applies anti-corrosion materials to the parts repaired or replaced.**

**NOTICE**

**Matte paint finish vehicle**

In case of matte paint finish vehicles, it is impossible to modify only the damaged area and repair of the whole part is necessary. If the vehicle is damaged and painting is required, have your vehicle maintained and repaired by an authorized retailer of Genesis Branded products. Take extreme care, as it is difficult to restore the quality after the repair.

### **Bright-metal maintenance**

- To remove road tar and insects, use a tar remover, not a scraper or other sharp object.
- To protect the surfaces of brightmetal parts from corrosion, apply a coating of wax or chrome preservative and rub to a high luster.
- During winter weather or in coastal areas, cover the bright metal parts with a heavier coating of wax or preservative. If necessary, coat the parts with non-corrosive petroleum jelly or other protective compound.

### **Underbody maintenance**

Corrosive materials used for ice and snow removal and dust control may collect on the underbody. If these materials are not removed, accelerated rusting can occur on underbody parts such as the fuel lines, frame, floor pan and exhaust system, even though they have been treated with rust protection. Thoroughly flush the vehicle underbody and wheel openings with lukewarm or cold water once a month, after off-road driving and at the end of each winter. Pay special attention to these areas because it will do more harm than good if the road grime becomes wet without removing it. The lower edges of doors, rocker panels, and frame members have drain holes that should not be allowed to clog with dirt; trapped water in these areas can cause rusting.



### **WARNING**

**After washing the vehicle, test the brakes while driving slowly to see if they have been affected by water. If braking performance is impaired, dry the brakes by applying them lightly while maintaining a slow forward speed.**

### **Aluminum wheel maintenance**

The aluminum wheels are coated with a clear protective finish.

- Do not use abrasive cleaner, polishing compound, solvent, or wire brushes on aluminum wheels.
- Clean the wheel when it has cooled.
- Use only a mild soap or neutral detergent, and rinse thoroughly with water. Also, clean the wheels after driving on salted roads.
- Do not wash the wheels with high-speed car wash brushes.
- Do not use any cleaners containing acid or alkaline detergents.

### **Corrosion protection**

#### **Protecting your vehicle from corrosion**

By using the most advanced design and construction practices to combat corrosion, Genesis Branded Vehicle produces vehicles of the highest quality. However, this is only part of the job. To achieve the long-term corrosion resistance, the owner's cooperation and assistance is also required.

#### **Common causes of corrosion**

The most common causes of corrosion on your vehicle are:

- Road salt, dirt and moisture that is allowed to accumulate underneath the vehicle.
- Removal of paint or protective coatings by stones, gravel, abrasion or minor scrapes and dents which leave unprotected metal exposed to corrosion.

#### **High-corrosion areas**

If you live in an area where your vehicle is regularly exposed to corrosive materials, corrosion protection is particularly important. Some of the common causes of accelerated corrosion are road salts, dust control chemicals, ocean air and industrial pollution.

#### **Moisture breeds corrosion**

Moisture creates the conditions in which corrosion is most likely to occur. For example, corrosion is accelerated by high humidity, particularly when temperatures are just above freezing. In such conditions, the corrosive material is kept in contact with the vehicle surfaces by moisture that is slow to evaporate.

Mud is particularly corrosive because it is slow to dry and holds moisture in contact with the vehicle. Although the mud appears to be dry, it can still retain moisture and promote corrosion.

High temperatures can also accelerate corrosion of parts that are not properly ventilated so the moisture can be dispersed. For all these reasons, it is particularly important to keep your vehicle clean and free of mud or accumulations of other materials. This applies not only to the visible surfaces but particularly to the underside of the vehicle.

### **To help prevent corrosion**

#### **Keep your vehicle clean**

The best way to prevent corrosion is to keep your vehicle clean and free of corrosive materials. Attention to the underside of the vehicle is particularly important.

- If you live in a high-corrosion area — where road salts are used, near the ocean, areas with industrial pollution, acid rain, etc.—, you should take extra care to prevent corrosion. In winter, hose off the underside of your vehicle at least once a month and be sure to clean the underside thoroughly when winter is over.
- When cleaning underneath the vehicle, pay particular attention to the components under the fenders and other areas that are hidden from view. Do a thorough job; just dampening the accumulated mud rather than washing it away will accelerate corrosion rather than prevent it. Water under high pressure and steam are particularly effective in removing accumulated mud and corrosive materials.
- When cleaning lower door panels, rocker panels and frame members, be sure that drain holes are kept open so that moisture can escape and not be trapped inside to accelerate corrosion.

#### *Keep your garage dry*

Don't park your vehicle in a damp, poorly ventilated garage. This creates a favorable environment for corrosion. This is particularly true if you wash your vehicle in the garage or drive it into the garage when it is still wet or covered with snow, ice or mud. Even a heated garage can contribute to corrosion unless it is well ventilated so moisture is dispersed.

#### *Keep paint and trim in good condition*

Scratches or chips in the finish should be covered with “touch-up” paint as soon as possible to reduce the possibility of corrosion. If bare metal is showing through, the attention of a qualified body and paint shop is recommended.

Bird droppings are highly corrosive and may damage painted surfaces in just a few hours. Always remove bird droppings as soon as possible.

## Interior Care

### *Interior general precautions*

Prevent caustic solutions such as perfume and cosmetic oil, from contacting the interior parts because they may cause damage or discoloration. If they do contact the interior parts, wipe them off immediately. See the instructions for the proper way to clean vinyl.

#### **NOTICE**

- **Never allow water or other liquids to come in contact with electrical/electronic components inside the vehicle as this may damage them.**
- **When cleaning leather products (steering wheel, seats etc.), use neutral detergents or low alcohol content solutions. If you use high alcohol content solutions or acid/alkaline detergents, the color of the leather may fade or the surface may get stripped off.**

### *Cleaning the upholstery and interior trim*

#### **Vinyl**

Remove dust and loose dirt from vinyl with a whisk broom or vacuum cleaner. Clean vinyl surfaces with a vinyl cleaner.

#### **Fabric**

Remove dust and loose dirt from fabric with a whisk broom or vacuum cleaner. Clean with a mild soap solution recommended for upholstery or carpets. Remove fresh spots immediately with a fabric spot cleaner. If fresh spots do not receive immediate attention, the fabric can be stained and its color can be affected. Also, its fire-resistant properties can be reduced if the material is not properly maintained.

#### **NOTICE**

**Using anything but recommended cleaners and procedures may affect the fabric's appearance and fire-resistant properties.**

## Leather

- Features of seat leather
  - Leather is made from the outer skin of an animal, which goes through a special process to be available for use. Since it is a natural product, each part differs in thickness or density.

Wrinkles may appear as a natural result of stretching and shrinking depending on the temperature and humidity.

  - The seat is made of stretchable fabric to improve comfort.
  - The parts contacting the body are curved and the side supporting area is high which provides driving comfort and stability.
  - Wrinkles may appear naturally from usage. It is not a fault of the products.

### NOTICE

- **Wrinkles or abrasions which appear naturally from usage are not covered by warranty.**
- **Belts with metallic accessories, zippers or keys inside the back pocket may damage the seat fabric.**
- **Make sure not to wet the seat. It may change the nature of natural leather.**
- **Jeans or clothes which could bleach may contaminate the surface of the seat covering fabric.**

- Caring for the leather seats
  - Vacuum the seat periodically to remove dust and sand on the seat. It will prevent abrasion or damage of the leather and maintain its quality.
  - Wipe the natural leather seat cover often with dry or soft cloth.
  - Use of proper leather protector may prevent abrasion of the cover and helps maintain the color. Be sure to read the instructions and consult a specialist when using leather coating or protective agent.
  - Light colored (such as beige or cream beige) leather is easily contaminated and the stain is noticeable. Clean the seats frequently.
  - Avoid wiping with wet cloth. It may cause the surface to crack.
- Cleaning the leather seats
  - Remove all contaminations instantly. Refer to instructions below for removal of each contaminant.
  - Cosmetic products (sunscreen, foundation, etc.)
    - Apply cleansing cream on a cloth and wipe the contaminated spot. Wipe off the cream with a wet cloth and remove water with a dry cloth.
  - Beverages (coffee, soft drink, etc.)
    - Apply a small amount of neutral detergent and wipe until contaminations do not smear.
  - Oil
    - Remove oil instantly with absorbable cloth and wipe with stain remover used only for natural leather.
  - Chewing gum
    - Harden the gum with ice and remove gradually.

- Handling prime napa leather  
Try to avoid excessive sunlight and heat exposure. Excessive sunlight and heat exposure naturally fades and dries out napa leather, causing wrinkles and discoloration. If the napa leather is wet with liquid, immediately clean it with lint-free cloth to minimize damage. Do not scratch the napa leather surface with a sharp object. If your napa leather seat is bright colored, it may be contaminated or stained from dyed materials such as jeans.

### ***Interior wooden trim***

- Use a wooden furniture protector (e.g. wax, coating compound) to clean the interior wooden trim.
- Wipe the interior wooden trim with a lint-free, clean cloth to maintain the unique wooden textures for a longer period of time.
- If you spill beverage (e.g. water, coffee) over the interior wooden trim, immediately wipe it with clean, dry cloth.
- Sharp objects (e.g. driver, knife), adhesive materials, or tapes may damage the interior wooden trim.
- Any strong impacts may damage the interior wooden trim.
- If the coating finish over the interior wooden trim is removed, moisture may damage or change wood traits.
- If the interior wooden trim is damaged, you may get a splinter from the wood surface. Therefore, you should immediately have the damaged interior wooden trim replaced by an authorized retailer of Genesis Branded products.

### ***Cleaning the seat belt webbing***

Clean the belt webbing with any mild soap solution recommended for cleaning upholstery or carpet. Follow the instructions provided with the soap. Do not bleach or re-dye the webbing because this may weaken the seat belt.

### ***Cleaning the interior window glass***

If the interior glass surfaces of the vehicle become fogged (that is, covered with an oily, greasy or waxy film), they should be cleaned with glass cleaner. Follow the directions on the glass cleaner container.

### **NOTICE**

**Do not scrape or scratch the inside of the rear window. This may result in damage to the rear window defroster grid.**

## EMISSION CONTROL SYSTEM

The emission control system of your vehicle is covered by a written limited warranty. Please see the warranty information contained in the Owner's Handbook & Warranty Information booklet in your vehicle.

Your vehicle is equipped with an emission control system to meet all applicable emission regulations. There are three emission control systems, as follows.

- (1) Crankcase emission control system
- (2) Evaporative emission control system
- (3) Exhaust emission control system

In order to ensure the proper function of the emission control systems, it is recommended that you have your vehicle inspected and maintained by an authorized retailer of Genesis Branded products in accordance with the maintenance schedule in this manual.

### NOTICE

#### For the Inspection and Maintenance Test (with Electronic Stability Control (ESC) system)

- **To prevent the vehicle from misfiring during dynamometer testing, turn the Electronic Stability Control (ESC) system off by pressing the ESC switch (ESC OFF light illuminated).**
- **After dynamometer testing is completed, turn the ESC system back on by pressing the ESC switch again.**

### 1. Crankcase Emission Control System

The positive crankcase ventilation system is employed to prevent air pollution caused by blow-by gases being emitted from the crankcase. This system supplies fresh filtered air to the crankcase through the air intake hose. Inside the crankcase, the fresh air mixes with blow-by gases, which then pass through the PCV valve into the induction system.

### 2. Evaporative Emission Control System Including Onboard Refueling Vapor Recovery (ORVR)

The Evaporative Emission Control System is designed to prevent fuel vapors from escaping into the atmosphere. The ORVR system is designed to allow the vapors from the fuel tank to be loaded into a canister while refueling at the gas station, preventing the escape of fuel vapors into the atmosphere.

#### *Canister*

Fuel vapors generated inside the fuel tank are absorbed and stored in the onboard canister. When the engine is running, the fuel vapors absorbed in the canister are drawn into the surge tank through the purge control solenoid valve.

#### *Purge Control Solenoid Valve (PCSV)*

The purge control solenoid valve is controlled by the Engine Control Module (ECM); when the engine coolant temperature is low during idling, the PCSV closes so that evaporated fuel is not taken into the engine. After the engine warms up during ordinary driving, the PCSV opens to introduce evaporated fuel to the engine.



### 3. Exhaust Emission Control System

The Exhaust Emission Control System is a highly effective system which controls exhaust emissions while maintaining good vehicle performance.

When the engine starts or fails to start, excessive attempts to restart the engine may cause damage to the emission system.

#### ***Engine exhaust (carbon monoxide) precautions***

- Carbon monoxide can be present with other exhaust fumes. If you smell exhaust fumes of any kind in your vehicle, drive with all the windows fully open. Have your vehicle checked and repaired immediately.



#### **WARNING**

**Engine exhaust gases contain carbon monoxide (CO). Though colorless and odorless, it is dangerous and could be lethal if inhaled. Follow the instructions on this page to avoid CO poisoning.**



#### **WARNING**

#### **CALIFORNIA PROPOSITION 65 WARNING**

**Engine exhaust and a wide variety of automobile components and parts, including components found in the interior furnishings in a vehicle, contain or emit chemicals known to the State of California to cause cancer and birth defects and reproductive harm. In addition, certain fluids contained in vehicles and certain products of component wear contain or emit chemicals known to the State of California to cause cancer and birth defects or other reproductive harm.**

Do not operate the engine in confined or closed areas (such as garages) any more than what is necessary to move the vehicle in or out of the area.

- When the vehicle is stopped in an open area for more than a short time with the engine running, adjust the ventilation system (as needed) to draw outside air into the vehicle.
- Never sit in a parked or stopped vehicle for any extended time with the engine running.
- When the engine stalls or fails to start, excessive attempts to restart the engine may cause damage to the emission control system.

## Operating precautions for catalytic converters



### WARNING

The exhaust system and catalytic converter are very hot during and immediately after the engine has been running. To avoid **SERIOUS INJURY or DEATH**:

- Do not park, idle, or drive the vehicle over or near flammable objects, such as grass, vegetation, paper, leaves, etc. A hot exhaust system can ignite flammable items under your vehicle.
- Keep away from the exhaust system and catalytic converter or you may get burned.

**Also, do not remove the heat sink around the exhaust system, do not seal the bottom of the vehicle, and do not coat the vehicle for corrosion control. It may present a fire risk under certain conditions.**

Your vehicle is equipped with a catalytic converter emission control device. To prevent damage to the catalytic converter and to your vehicle, take the following precautions:

- Use only UNLEADED FUEL for gasoline engines.
- Do not operate the vehicle when there are signs of engine malfunction, such as misfire or a noticeable loss of performance.
- Do not misuse or abuse the engine. Examples of misuse are coasting with the engine off and descending steep grades in gear with the engine off.
- Do not operate the engine at high idle speed for extended periods (5 minutes or more).

- Do not modify or tamper with any part of the engine or emission control system. All inspections and adjustments must be made by an authorized retailer of Genesis Branded products.
- Avoid driving with an extremely low fuel level.

Running out of fuel could cause the engine to misfire, damaging the catalytic converter.

## CALIFORNIA PERCHLORATE NOTICE

Perchlorate Material-special handling may apply, See: [www.dtsc.ca.gov/hazardouswaste/perchlorate](http://www.dtsc.ca.gov/hazardouswaste/perchlorate).

Notice to California Vehicle Dismantlers: Perchlorate containing materials, such as air bag inflators, seatbelt pretensioners and keyless remote entry batteries, must be disposed of according to Title 22 California Code of Regulations Section 67384.10 (a).